

INDIVIDUAL SHOOTING RESULTS

Pentathlon World Cup Sofia, BULGARIA 2024 - WOMEN'S FINAL

Elodie CLOUVEL (FRA)

Heat 1			
	H	P	D
Tot	5/7/12	7,0	24,23
1	-	5,4	-
2	O	8,7	2,35
3	-	4,9	2,16
4	-	6,8	2,30
5	-	7,2	2,29
6	O	9,0	2,18
7	-	6,9	2,09
8	O	7,5	2,19
9	-	4,2	2,17
10	O	7,6	2,11
11	-	6,3	2,11
12	O	9,3	2,28

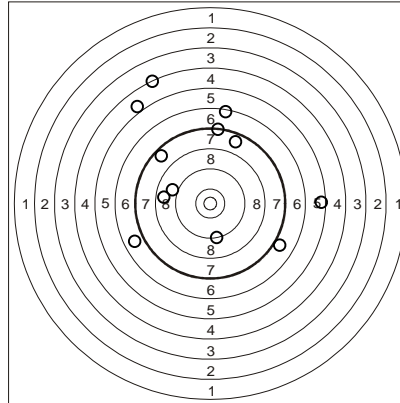

Heat 2			
	H	P	D
Tot	5/6/11	7,4	25,62
1	-	5,4	-
2	O	8,0	6,29
3	-	5,9	2,12
4	-	6,6	2,17
5	-	6,5	2,12
6	O	10,2	2,18
7	O	8,6	2,11
8	-	6,7	2,09
9	-	6,2	2,17
10	O	8,9	2,21
11	O	8,7	2,16

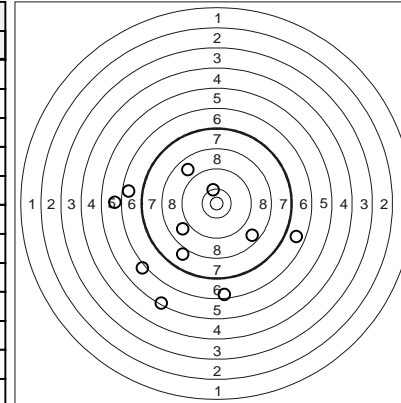

Heat 3			
	H	P	D
Tot	4/17/21	5,1	49,98
1	O	7,8	-
2	O	7,4	2,12
3	O	7,9	2,06
4	-	3,7	2,00
5	-	5,3	1,98
6	-	4,0	2,11
7	-	4,2	2,14
8	-	0,0	2,36
9	-	5,7	2,18
10	-	6,8	2,21
11	-	2,7	4,41
12	-	4,2	2,24
13	-	4,8	2,24
14	-	4,0	2,12
15	-	3,9	2,27
16	-	3,8	2,25
17	-	4,9	2,34
18	-	4,9	2,40
19	O	8,6	2,24
20	-	5,5	2,29
21	-	6,6	2,32

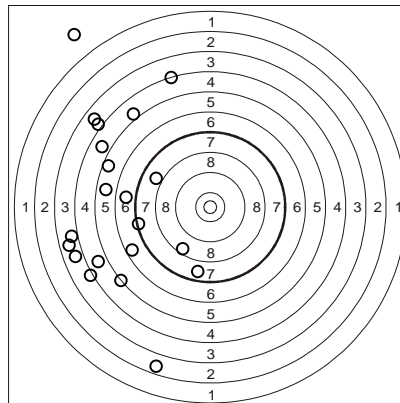

Heat 4			
	H	P	D
Tot	5/9/14	6,9	31,83
1	-	6,6	-
2	-	6,1	4,25
3	-	4,7	2,88
4	-	6,6	2,21
5	-	6,2	2,31
6	-	6,1	2,40
7	O	8,4	2,31
8	-	6,5	2,25
9	-	6,7	2,24
10	O	9,6	2,32
11	-	1,4	2,14
12	O	8,7	2,16
13	O	9,3	2,16
14	O	9,5	2,20

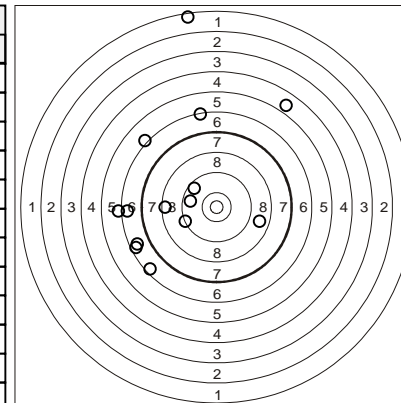

INDIVIDUAL SHOOTING RESULTS

Pentathlon World Cup Sofia, BULGARIA 2024 - WOMEN'S FINAL

Marlena JAWAID (SWE)

Heat 1			
	H	P	D
Tot	5/8/13	7,0	25,00
1	O	7,7	-
2	O	7,8	2,50
3	-	6,7	2,08
4	O	9,7	2,06
5	-	7,1	1,76
6	-	6,1	1,87
7	-	3,6	1,99
8	O	7,9	2,14
9	-	7,1	2,18
10	-	7,0	2,22
11	-	5,2	2,22
12	-	4,7	2,02
13	O	10,4	1,96

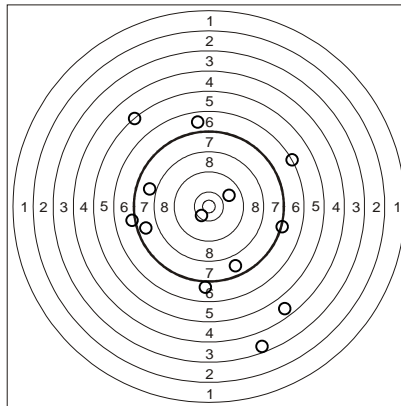

Heat 2			
	H	P	D
Tot	5/2/7	8,1	12,02
1	O	7,5	-
2	O	10,1	2,23
3	O	7,4	2,01
4	-	6,9	1,90
5	O	9,4	1,97
6	-	5,7	1,90
7	O	9,4	2,01

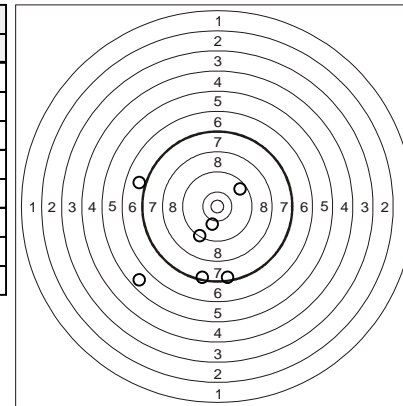

Heat 3			
	H	P	D
Tot	5/6/11	6,3	21,27
1	-	6,3	-
2	-	3,5	2,33
3	-	5,7	2,16
4	O	8,8	2,22
5	O	8,8	2,17
6	O	8,6	2,07
7	-	2,1	1,83
8	-	6,6	2,16
9	-	3,4	2,09
10	O	8,0	2,07
11	O	7,9	2,17

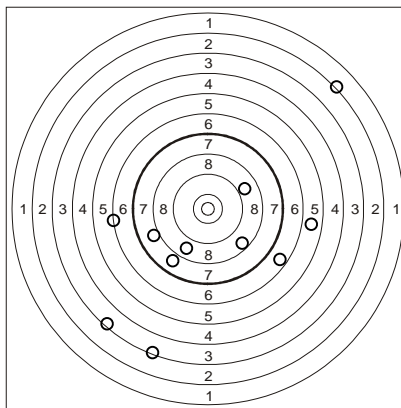

Heat 4			
	H	P	D
Tot	5/4/9	7,4	15,97
1	-	4,7	-
2	-	6,9	2,31
3	-	6,4	1,92
4	O	9,1	2,06
5	-	3,1	1,96
6	O	9,8	1,99
7	O	10,4	1,82
8	O	7,8	1,98
9	O	8,0	1,93

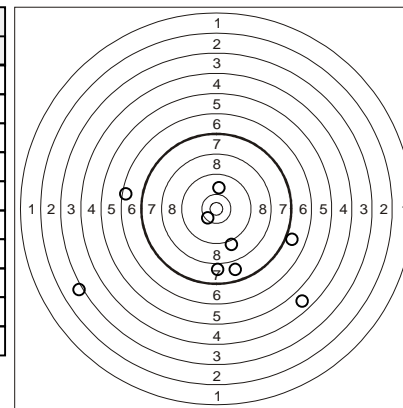

INDIVIDUAL SHOOTING RESULTS

Pentathlon World Cup Sofia, BULGARIA 2024 - WOMEN'S FINAL

Elzbieta ADOMAITYTE (LTU)

Heat 1			
	H	P	D
Tot	5/5/10	7,0	20,12
1	O	9,2	-
2	-	7,0	2,35
3	O	7,3	3,57
4	-	4,4	2,35
5	-	4,6	2,08
6	-	2,5	1,86
7	O	9,1	1,86
8	O	9,6	2,03
9	-	7,1	1,95
10	O	8,9	2,07

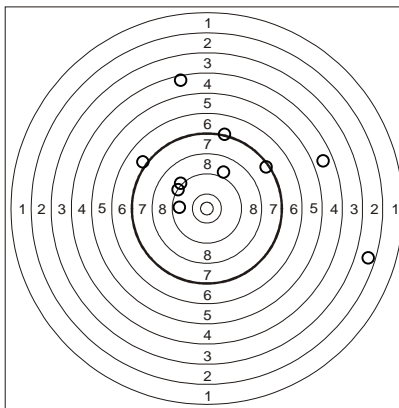

Heat 2			
	H	P	D
Tot	5/5/10	6,3	16,99
1	-	5,7	-
2	-	4,3	1,86
3	O	8,7	1,83
4	-	4,5	1,79
5	O	9,2	1,96
6	O	7,6	1,80
7	-	3,5	1,88
8	-	4,0	2,20
9	O	7,5	1,83
10	O	7,8	1,84

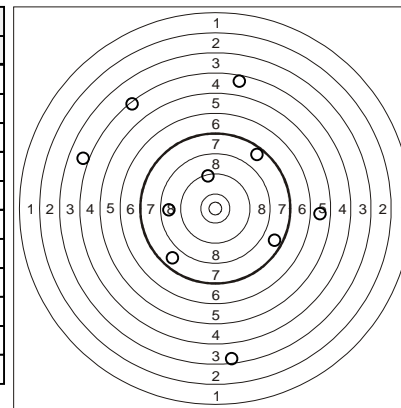

Heat 3			
	H	P	D
Tot	5/9/14	6,8	26,88
1	-	5,3	-
2	-	6,6	2,27
3	O	10,2	1,86
4	-	5,2	1,90
5	-	7,0	1,66
6	-	7,1	1,68
7	-	4,5	3,56
8	O	7,4	2,12
9	O	9,1	1,82
10	O	7,5	1,91
11	-	4,6	1,88
12	-	5,6	2,37
13	-	6,9	1,92
14	O	8,0	1,93

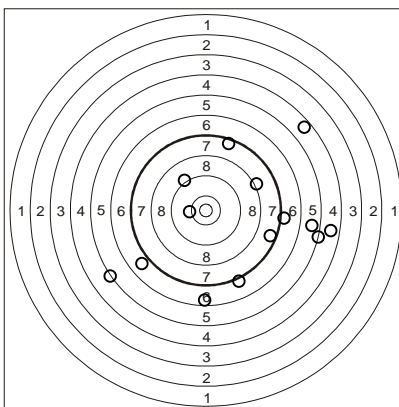

Heat 4			
	H	P	D
Tot	5/8/13	6,8	23,12
1	-	6,7	-
2	O	8,6	1,89
3	-	4,2	1,78
4	-	6,3	1,87
5	O	9,2	1,74
6	-	6,6	1,79
7	O	9,1	2,03
8	O	10,5	2,09
9	-	3,0	1,94
10	-	6,7	2,03
11	-	4,1	1,93
12	-	5,9	1,93
13	O	8,0	2,10

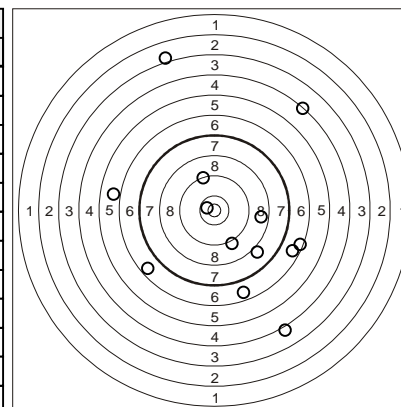

INDIVIDUAL SHOOTING RESULTS

Pentathlon World Cup Sofia, BULGARIA 2024 - WOMEN'S FINAL

Jessica VARLEY (GBR)

Heat 1			
	H	P	D
Tot	5/1/6	9,3	11,41
1	O	9,1	-
2	O	10,1	2,40
3	-	6,8	2,22
4	O	9,9	2,23
5	O	9,4	2,35
6	O	10,3	2,21

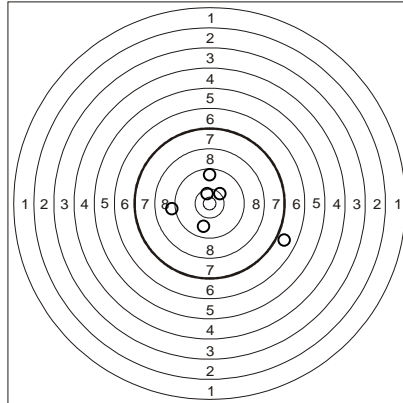

Heat 2			
	H	P	D
Tot	5/0/5	8,4	8,57
1	O	7,6	-
2	O	9,6	2,40
3	O	9,1	2,18
4	O	7,3	2,01
5	O	8,6	1,98

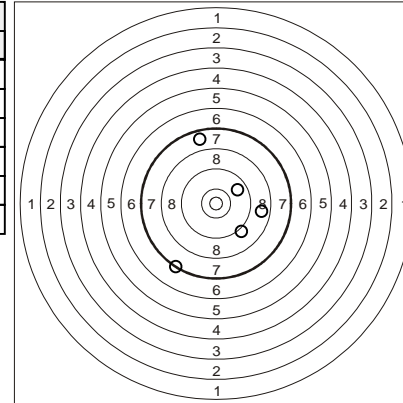

Heat 3			
	H	P	D
Tot	5/4/9	7,4	16,52
1	O	8,0	-
2	-	7,2	2,29
3	O	8,6	2,11
4	O	10,1	2,11
5	O	7,7	2,02
6	-	6,6	2,02
7	-	6,4	2,11
8	-	4,0	1,97
9	O	7,7	1,89

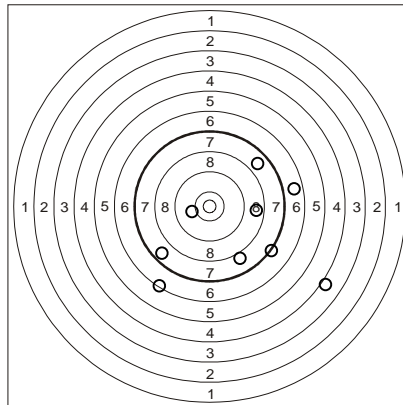

Heat 4			
	H	P	D
Tot	5/2/7	8,0	12,88
1	O	7,9	-
2	O	8,3	2,34
3	O	9,9	2,02
4	-	6,4	2,01
5	-	6,2	2,12
6	O	9,2	2,47
7	O	8,3	1,92

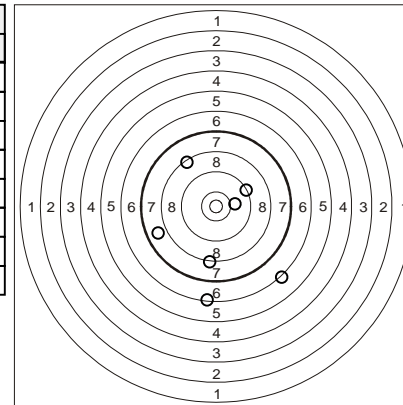

INDIVIDUAL SHOOTING RESULTS

Pentathlon World Cup Sofia, BULGARIA 2024 - WOMEN'S FINAL

Malak ISMAIL (EGY)

Heat 1			
	H	P	D
Tot	5/0/5	8,3	7,58
1	O	7,8	-
2	O	8,3	1,99
3	O	7,5	1,95
4	O	10,0	1,92
5	O	7,9	1,72

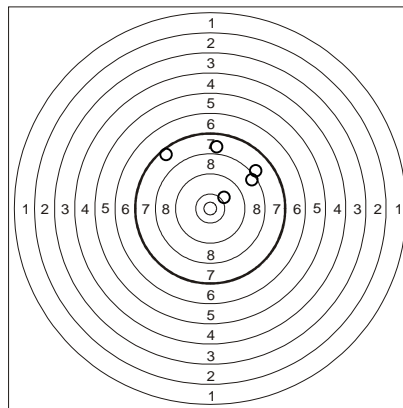

Heat 2			
	H	P	D
Tot	5/1/6	8,4	8,79
1	O	9,6	-
2	O	7,3	1,91
3	O	8,8	1,80
4	-	6,6	1,73
5	O	8,8	1,65
6	O	9,3	1,70

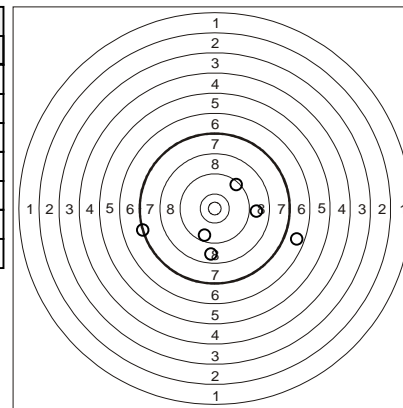

Heat 3			
	H	P	D
Tot	5/1/6	8,3	9,69
1	O	8,1	-
2	O	7,7	1,81
3	O	9,8	1,72
4	O	9,8	1,64
5	-	6,9	1,63
6	O	7,3	2,89

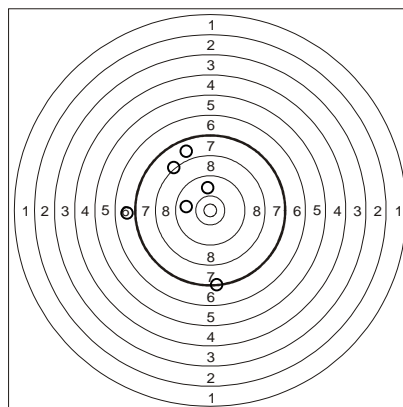

Heat 4			
	H	P	D
Tot	5/0/5	8,6	6,56
1	O	7,8	-
2	O	10,1	1,77
3	O	9,5	1,66
4	O	7,7	1,60
5	O	7,7	1,53

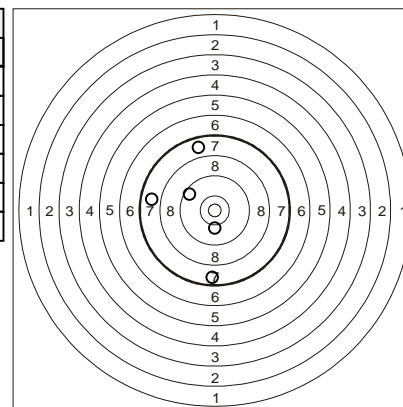

INDIVIDUAL SHOOTING RESULTS

Pentathlon World Cup Sofia, BULGARIA 2024 - WOMEN'S FINAL

Salma ABDELMAKSoud (EGY)

Heat 1			
	H	P	D
Tot	5/1/6	8,1	8,82
1	O	7,3	-
2	O	10,0	1,88
3	O	7,3	1,71
4	O	9,6	1,79
5	-	5,4	1,68
6	O	9,1	1,76

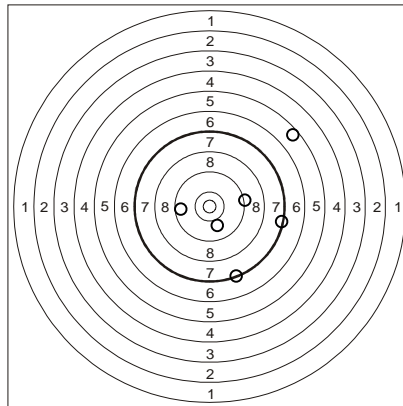

Heat 2			
	H	P	D
Tot	5/0/5	9,4	6,97
1	O	8,9	-
2	O	10,5	1,70
3	O	8,8	1,73
4	O	8,4	1,83
5	O	10,3	1,71

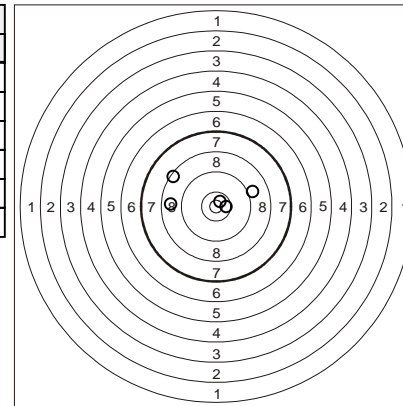

Heat 3			
	H	P	D
Tot	5/4/9	8,1	14,84
1	-	7,2	-
2	-	6,6	1,99
3	O	9,9	1,64
4	O	7,6	1,91
5	O	9,2	1,64
6	O	10,3	1,77
7	-	7,2	1,51
8	-	5,3	2,27
9	O	9,3	2,11

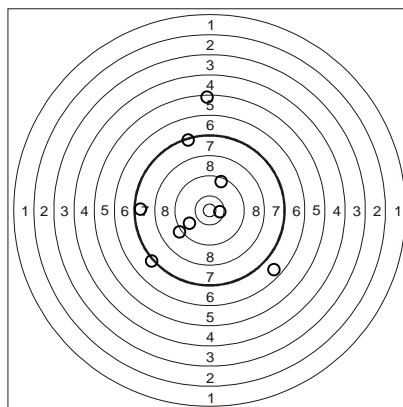

Heat 4			
	H	P	D
Tot	5/2/7	7,7	10,35
1	O	10,3	-
2	O	9,0	1,83
3	-	4,5	1,67
4	-	6,7	1,72
5	O	8,0	1,82
6	O	7,7	1,66
7	O	7,6	1,65

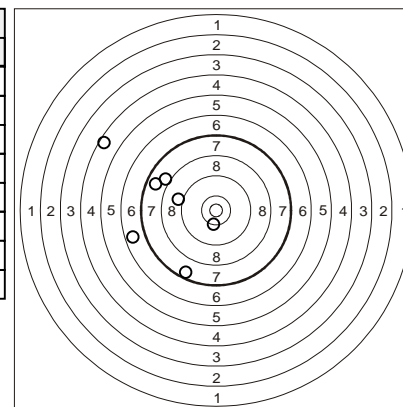

INDIVIDUAL SHOOTING RESULTS

Pentathlon World Cup Sofia, BULGARIA 2024 - WOMEN'S FINAL

Blanka GUZI (HUN)

Heat 1			
	H	P	D
Tot	5/4/9	7,9	17,84
1	O	10,1	-
2	-	6,9	2,21
3	O	7,9	2,12
4	-	6,8	2,08
5	-	5,3	2,14
6	O	8,6	2,20
7	O	10,1	2,26
8	-	5,4	2,50
9	O	9,7	2,33

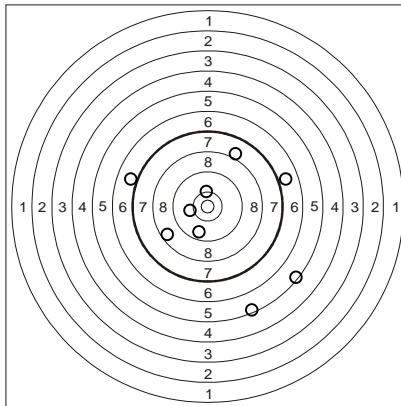

Heat 2			
	H	P	D
Tot	5/2/7	7,7	13,10
1	O	8,2	-
2	O	8,8	2,27
3	O	8,3	2,26
4	-	5,7	2,33
5	-	7,2	1,82
6	O	7,9	1,99
7	O	7,8	2,43

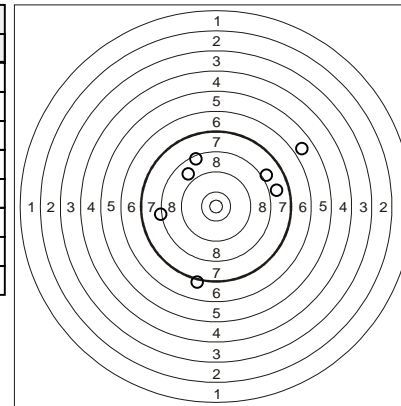

Heat 3			
	H	P	D
Tot	5/0/5	8,5	8,80
1	O	8,6	-
2	O	7,8	1,93
3	O	8,4	2,38
4	O	9,0	2,35
5	O	8,6	2,14

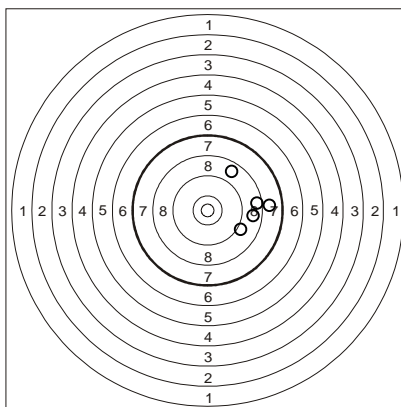

Heat 4			
	H	P	D
Tot	5/2/7	8,3	12,91
1	O	9,8	-
2	O	10,3	2,25
3	-	6,5	1,96
4	-	7,1	1,91
5	O	8,1	2,36
6	O	8,2	2,32
7	O	8,4	2,11

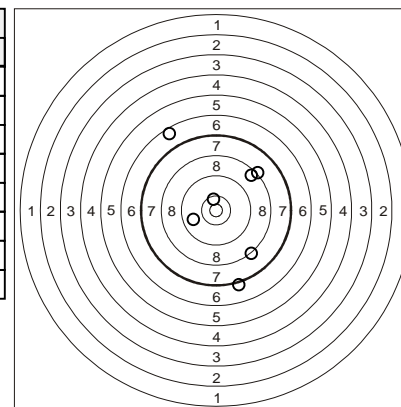

INDIVIDUAL SHOOTING RESULTS

Pentathlon World Cup Sofia, BULGARIA 2024 - WOMEN'S FINAL

Emma WHITAKER (GBR)

Heat 1			
	H	P	D
Tot	5/6/11	6,5	24,30
1	O	9,1	-
2	-	6,2	2,24
3	O	9,1	2,09
4	-	7,1	2,26
5	-	2,8	2,18
6	O	7,3	2,20
7	-	5,6	2,16
8	O	8,3	2,19
9	-	5,1	2,14
10	-	3,2	4,66
11	O	8,1	2,18

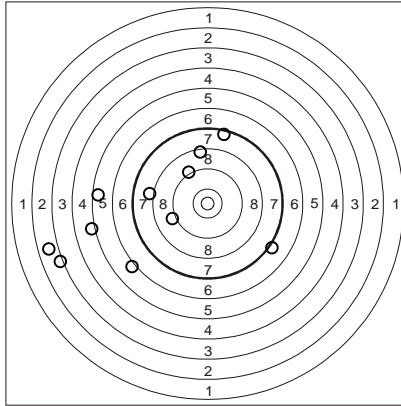

Heat 2			
	H	P	D
Tot	5/3/8	6,7	14,96
1	-	4,3	-
2	O	7,7	2,14
3	O	8,4	2,26
4	-	4,3	2,09
5	-	3,0	2,32
6	O	9,5	2,13
7	O	8,4	2,07
8	O	8,1	1,95

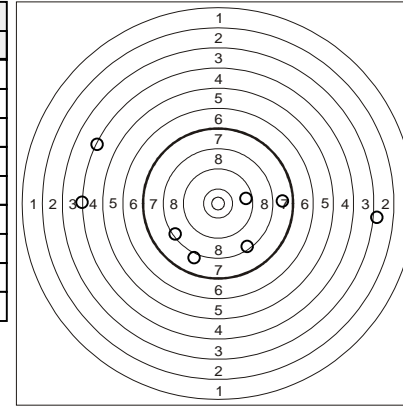

Heat 3			
	H	P	D
Tot	5/5/10	6,6	20,00
1	O	9,3	-
2	O	8,5	2,04
3	O	9,4	2,02
4	-	5,6	2,18
5	-	6,7	2,25
6	-	5,4	2,41
7	-	3,1	2,26
8	O	8,4	2,31
9	-	0,0	2,32
10	O	9,1	2,21

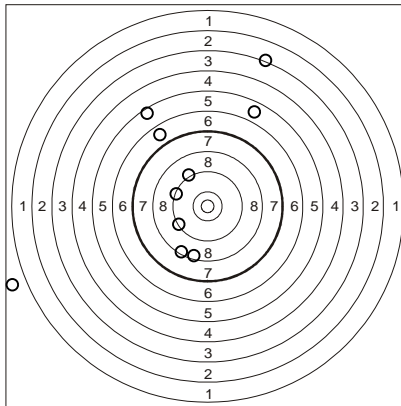

Heat 4			
	H	P	D
Tot	5/2/7	7,5	12,37
1	O	7,5	-
2	O	9,4	2,04
3	O	8,1	1,97
4	-	3,6	2,22
5	-	5,7	2,08
6	O	9,3	2,09
7	O	8,9	1,97

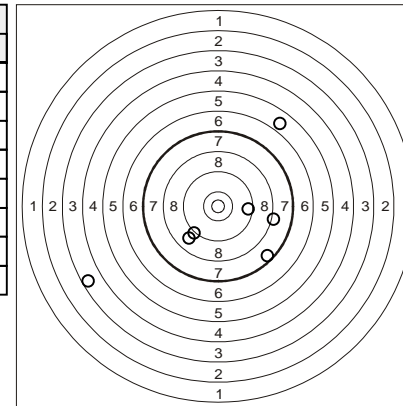

INDIVIDUAL SHOOTING RESULTS

Pentathlon World Cup Sofia, BULGARIA 2024 - WOMEN'S FINAL

Oiha KLUNNIKOVA (UKR)

Heat 1			
	H	P	D
Tot	5/2/7	7,2	12,78
1	O	8,0	-
2	-	7,2	2,10
3	O	8,6	2,30
4	O	7,6	2,03
5	O	7,5	2,15
6	-	3,9	1,99
7	O	7,8	2,21

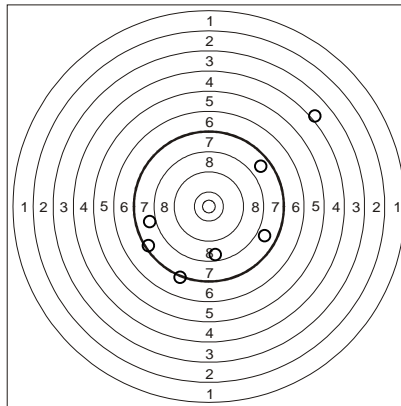

Heat 2			
	H	P	D
Tot	5/9/14	5,9	27,55
1	O	8,9	-
2	-	0,0	2,12
3	-	2,8	2,01
4	O	10,3	2,04
5	-	3,9	2,02
6	-	5,8	2,13
7	-	7,2	1,99
8	-	5,5	2,16
9	-	5,4	2,00
10	-	5,6	2,26
11	-	2,6	2,27
12	O	7,8	2,26
13	O	8,5	2,10
14	O	7,9	2,19

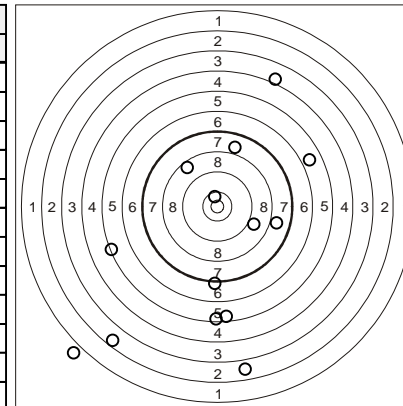

Heat 3			
	H	P	D
Tot	5/5/10	6,7	19,41
1	O	8,3	-
2	-	2,9	2,32
3	O	9,4	2,07
4	-	5,7	2,01
5	-	4,6	2,20
6	O	8,5	1,99
7	-	5,3	2,06
8	-	5,8	2,24
9	O	7,7	2,22
10	O	8,6	2,30

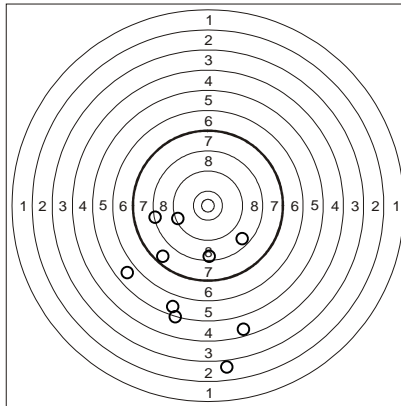

Heat 4			
	H	P	D
Tot	5/9/14	5,9	30,88
1	-	3,1	-
2	-	3,6	2,27
3	O	9,1	1,99
4	-	1,3	2,06
5	O	8,6	2,11
6	O	7,4	1,88
7	-	4,7	1,92
8	-	5,7	2,09
9	-	4,0	2,13
10	-	6,8	4,24
11	O	10,3	2,21
12	-	4,5	3,52
13	-	5,6	2,14
14	O	8,4	2,32

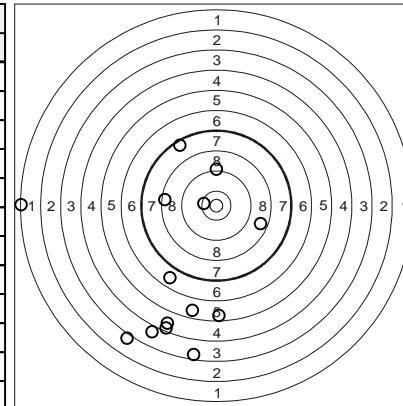

INDIVIDUAL SHOOTING RESULTS

Pentathlon World Cup Sofia, BULGARIA 2024 - WOMEN'S FINAL

Laura HEREDIA (ESP)

Heat 1			
	H	P	D
Tot	5/1/6	8,0	11,26
1	-	4,9	-
2	O	7,9	2,32
3	O	8,8	2,49
4	O	8,8	2,05
5	O	8,5	2,34
6	O	8,9	2,06

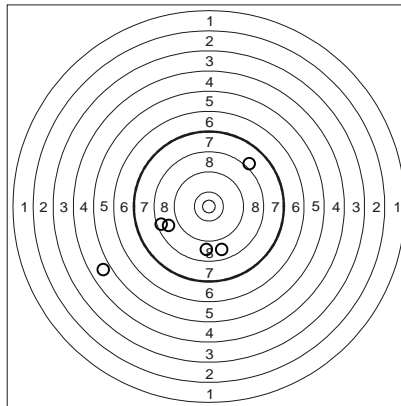

Heat 2			
	H	P	D
Tot	5/1/6	8,6	11,96
1	-	7,0	-
2	O	9,8	2,47
3	O	9,2	2,60
4	O	10,1	2,25
5	O	8,2	2,26
6	O	7,5	2,38

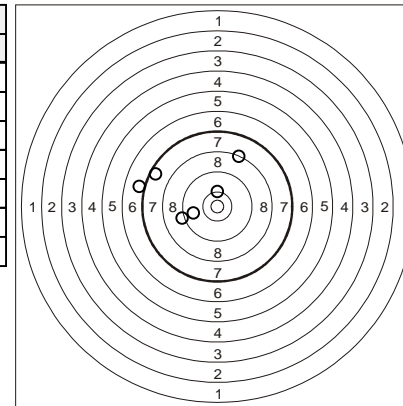

Heat 3			
	H	P	D
Tot	5/0/5	8,5	8,87
1	O	8,2	-
2	O	8,6	2,29
3	O	9,5	2,24
4	O	8,8	2,04
5	O	7,5	2,30

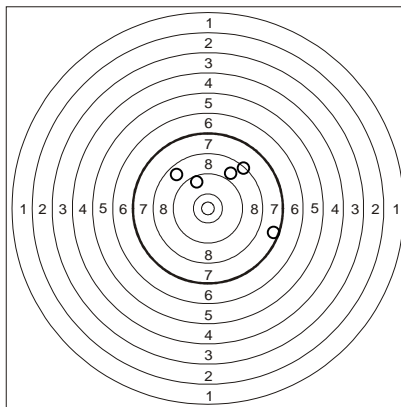

Heat 4			
	H	P	D
Tot	5/5/10	7,4	22,52
1	-	4,8	-
2	-	7,0	2,34
3	O	9,2	2,41
4	O	10,6	2,13
5	O	7,8	2,02
6	O	8,9	2,29
7	-	6,8	2,36
8	-	6,2	3,10
9	-	4,5	3,18
10	O	8,6	2,69

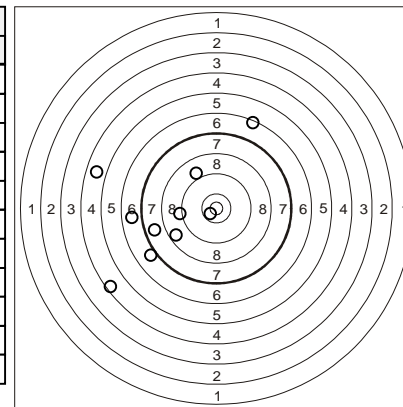

INDIVIDUAL SHOOTING RESULTS

Pentathlon World Cup Sofia, BULGARIA 2024 - WOMEN'S FINAL

Gintare VENCKAUSKAITE (LTU)

Heat 1			
	H	P	D
Tot	5/1/6	8,1	10,82
1	O	8,8	-
2	O	8,1	2,12
3	O	9,4	2,09
4	O	7,7	1,97
5	-	5,1	2,16
6	O	9,6	2,48

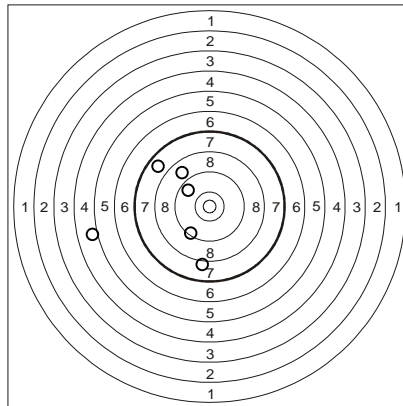

Heat 2			
	H	P	D
Tot	5/4/9	7,6	17,61
1	-	6,3	-
2	O	9,2	2,00
3	-	4,7	2,24
4	-	7,1	2,90
5	O	7,5	2,11
6	O	7,6	2,08
7	-	7,2	2,02
8	O	9,1	2,15
9	O	9,5	2,11

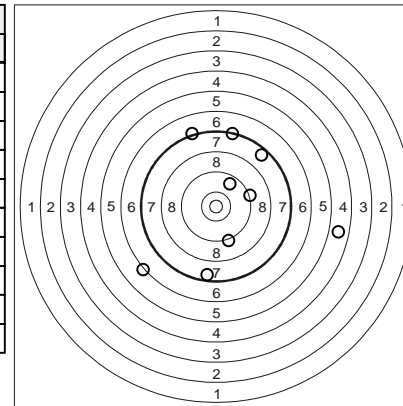

Heat 3			
	H	P	D
Tot	5/0/5	8,7	8,66
1	O	9,0	-
2	O	7,3	2,07
3	O	9,9	2,09
4	O	8,1	2,16
5	O	9,3	2,34

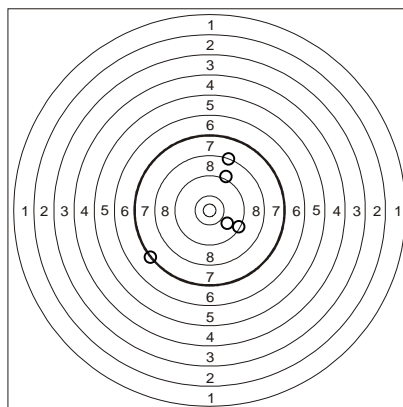

Heat 4			
	H	P	D
Tot	5/1/6	8,1	11,13
1	O	8,9	-
2	-	6,1	2,74
3	O	8,5	2,17
4	O	7,6	1,97
5	O	7,5	2,12
6	O	10,2	2,13

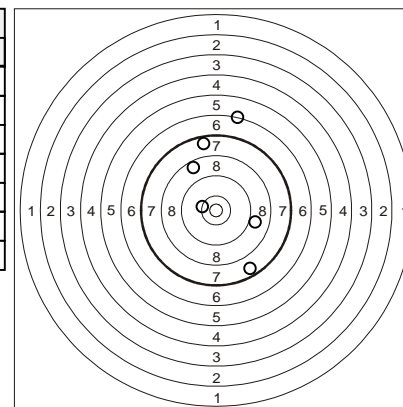

INDIVIDUAL SHOOTING RESULTS

Pentathlon World Cup Sofia, BULGARIA 2024 - WOMEN'S FINAL

Rita ERDOS (HUN)

Heat 1			
	H	P	D
Tot	5/2/7	7,8	11,46
1	O	8,0	-
2	O	8,3	2,05
3	O	7,9	1,79
4	-	6,6	1,72
5	O	8,5	1,93
6	-	6,9	1,91
7	O	8,6	2,06

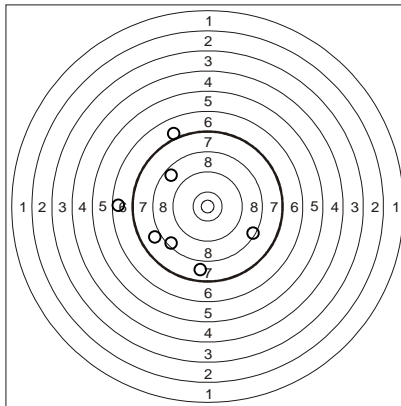

Heat 2			
	H	P	D
Tot	5/2/7	7,7	11,90
1	O	7,3	-
2	-	5,5	1,93
3	-	5,3	2,07
4	O	9,8	1,95
5	O	9,3	1,95
6	O	7,7	1,96
7	O	9,2	2,04

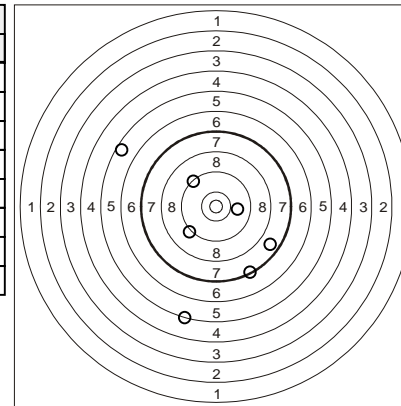

Heat 3			
	H	P	D
Tot	5/0/5	8,9	8,07
1	O	7,5	-
2	O	8,5	2,04
3	O	9,3	1,98
4	O	8,8	2,04
5	O	10,3	2,01

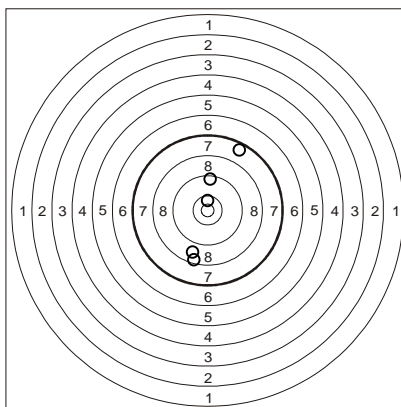

Heat 4			
	H	P	D
Tot	5/1/6	8,4	9,80
1	O	9,6	-
2	O	7,7	1,82
3	O	8,3	2,02
4	-	6,4	2,05
5	O	8,3	1,97
6	O	10,2	1,94

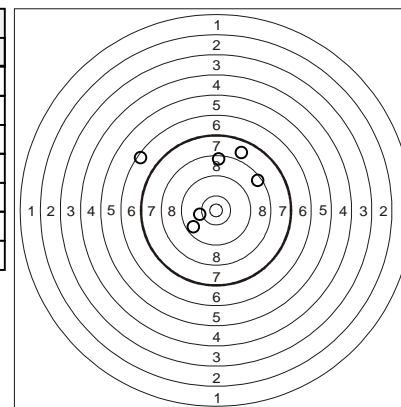

INDIVIDUAL SHOOTING RESULTS

Pentathlon World Cup Sofia, BULGARIA 2024 - WOMEN'S FINAL

Kate FRENCH (GBR)

Heat 1			
	H	P	D
Tot	5/1/6	8,3	11,82
1	-	5,5	-
2	O	7,9	2,53
3	O	9,6	2,51
4	O	8,5	2,14
5	O	8,0	2,28
6	O	10,1	2,36

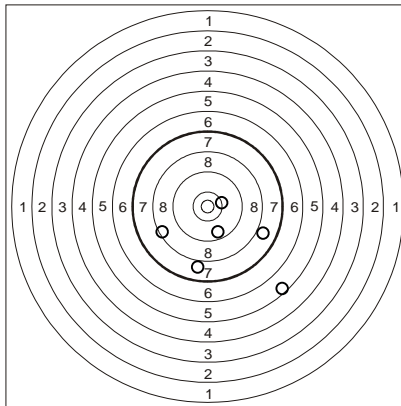

Heat 2			
	H	P	D
Tot	5/4/9	7,9	18,88
1	-	6,6	-
2	O	10,7	2,47
3	-	7,0	2,55
4	O	8,4	2,28
5	O	7,7	2,27
6	O	9,9	2,28
7	-	5,4	2,32
8	-	7,1	2,25
9	O	8,1	2,46

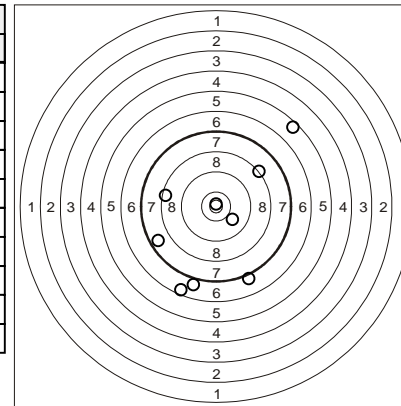

Heat 3			
	H	P	D
Tot	5/3/8	8,0	17,28
1	-	6,1	-
2	-	7,1	2,49
3	O	8,8	2,64
4	O	7,7	2,55
5	-	6,5	2,22
6	O	9,3	2,54
7	O	9,2	2,50
8	O	9,0	2,34

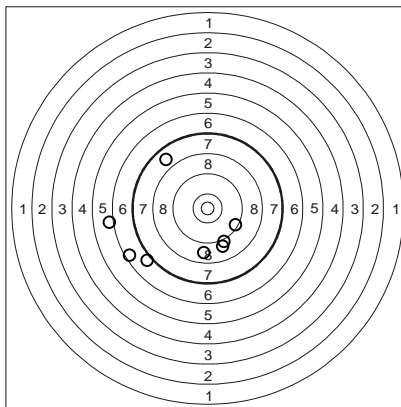

Heat 4			
	H	P	D
Tot	5/1/6	8,0	12,33
1	O	8,1	-
2	-	5,7	2,69
3	O	8,6	2,43
4	O	7,6	2,30
5	O	10,1	2,33
6	O	7,8	2,58

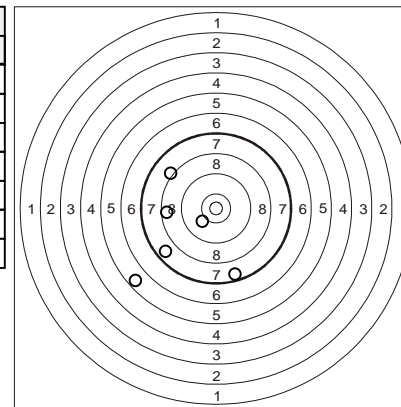

INDIVIDUAL SHOOTING RESULTS

Pentathlon World Cup Sofia, BULGARIA 2024 - WOMEN'S FINAL

Annika ZILLEKENS (GER)

Heat 1			
	H	P	D
Tot	5/2/7	7,7	14,87
1	-	6,4	-
2	-	6,1	2,58
3	O	8,4	2,39
4	O	7,7	2,35
5	O	8,0	2,50
6	O	8,0	2,62
7	O	9,4	2,43

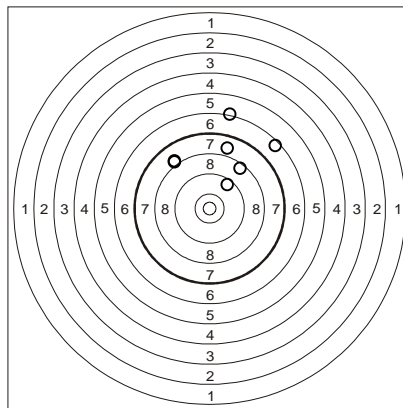

Heat 2			
	H	P	D
Tot	5/2/7	8,0	13,74
1	-	3,8	-
2	O	8,3	2,38
3	O	10,0	2,41
4	O	8,7	2,18
5	-	6,9	2,38
6	O	8,9	2,10
7	O	9,5	2,29

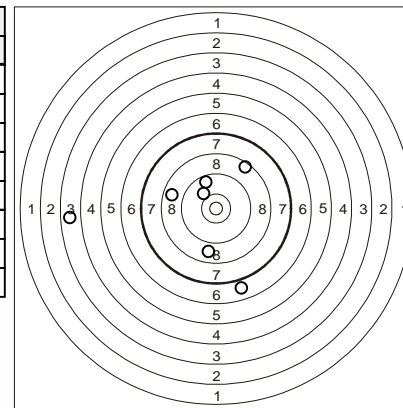

Heat 3			
	H	P	D
Tot	5/0/5	8,3	9,12
1	O	8,3	-
2	O	7,9	2,21
3	O	8,7	2,28
4	O	8,7	2,28
5	O	8,1	2,35

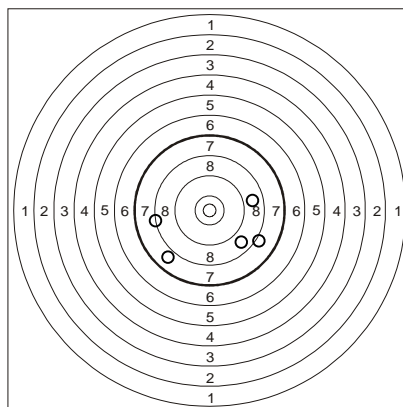

Heat 4			
	H	P	D
Tot	5/0/5	8,8	9,57
1	O	7,6	-
2	O	7,6	2,32
3	O	9,2	2,67
4	O	10,0	2,27
5	O	9,4	2,31

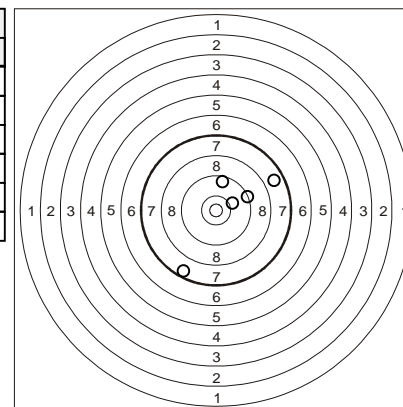

INDIVIDUAL SHOOTING RESULTS

Pentathlon World Cup Sofia, BULGARIA 2024 - WOMEN'S FINAL

Seungmin SEONG (KOR)

Heat 1			
	H	P	D
Tot	5/2/7	8,4	17,14
1	O	8,7	-
2	-	5,5	2,41
3	O	8,5	2,44
4	O	9,7	4,85
5	-	7,2	2,53
6	O	9,8	2,43
7	O	9,2	2,48

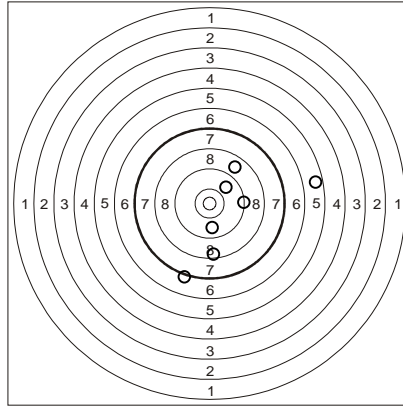

Heat 2			
	H	P	D
Tot	5/1/6	8,4	12,56
1	-	6,4	-
2	O	10,2	2,62
3	O	7,9	2,45
4	O	8,5	2,54
5	O	8,5	2,42
6	O	9,1	2,53

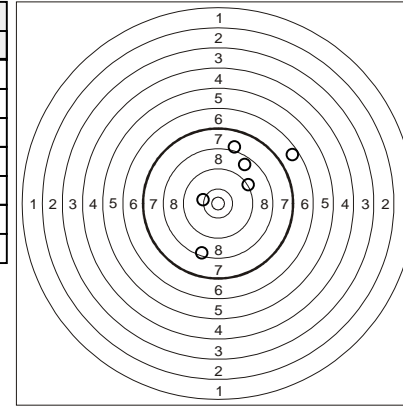

Heat 3			
	H	P	D
Tot	5/1/6	8,3	11,93
1	O	9,3	-
2	-	7,0	2,33
3	O	8,6	2,44
4	O	8,4	2,42
5	O	7,6	2,34
6	O	8,6	2,40

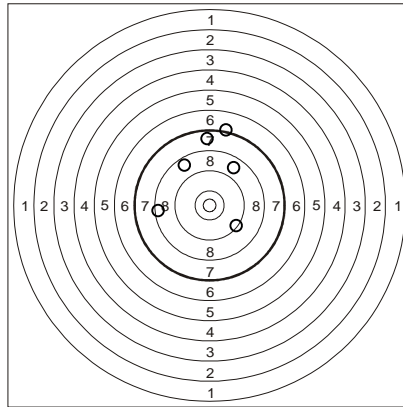

Heat 4			
	H	P	D
Tot	5/0/5	9,3	9,55
1	O	8,9	-
2	O	8,5	2,37
3	O	9,1	2,43
4	O	10,4	2,43
5	O	9,6	2,32

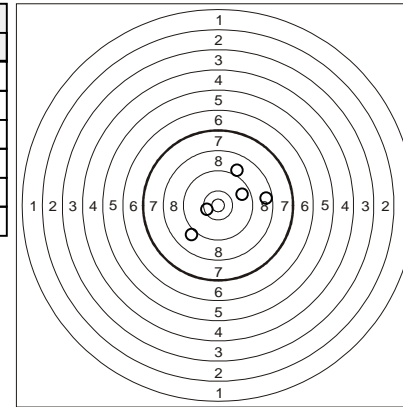

INDIVIDUAL SHOOTING RESULTS

Pentathlon World Cup Sofia, BULGARIA 2024 - WOMEN'S FINAL

Alice RINAUDO (ITA)

Heat 1			
	H	P	D
Tot	5/4/9	7,5	15,90
1	-	3,8	-
2	-	7,1	2,03
3	O	10,2	1,94
4	O	7,6	1,95
5	O	9,6	2,68
6	-	6,3	1,75
7	-	4,7	1,82
8	O	9,4	1,91
9	O	9,1	1,82

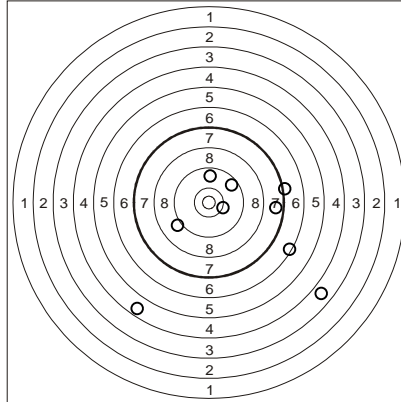

Heat 2			
	H	P	D
Tot	5/3/8	7,2	12,63
1	O	10,2	-
2	-	5,9	1,84
3	O	8,1	1,83
4	O	8,1	1,80
5	-	4,4	1,81
6	O	10,1	1,81
7	-	3,0	1,86
8	O	7,5	1,68

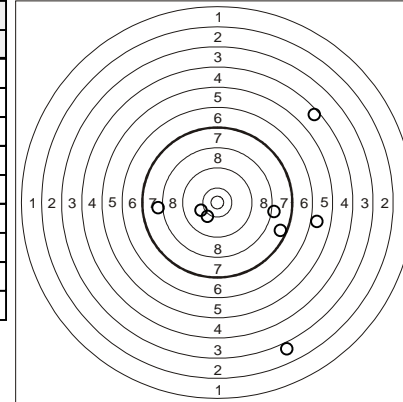

Heat 3			
	H	P	D
Tot	5/5/10	7,1	17,05
1	-	3,7	-
2	-	6,1	2,05
3	-	5,7	1,92
4	O	7,7	2,16
5	O	9,9	1,85
6	-	7,0	1,74
7	O	9,6	1,97
8	-	4,6	1,81
9	O	8,8	1,87
10	O	7,6	1,68

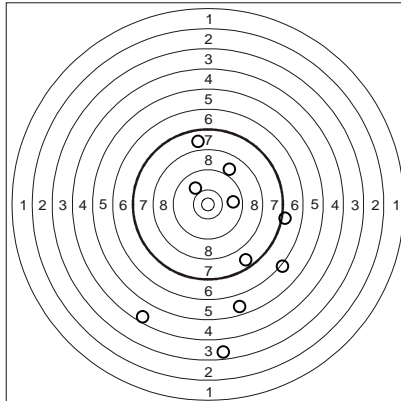

Heat 4			
	H	P	D
Tot	5/6/11	7,3	18,68
1	-	6,6	-
2	O	9,5	2,17
3	-	4,8	1,95
4	-	6,7	1,81
5	O	10,1	1,95
6	O	9,6	1,83
7	-	7,2	1,77
8	O	7,9	1,74
9	-	3,7	1,72
10	-	5,1	1,89
11	O	8,9	1,85

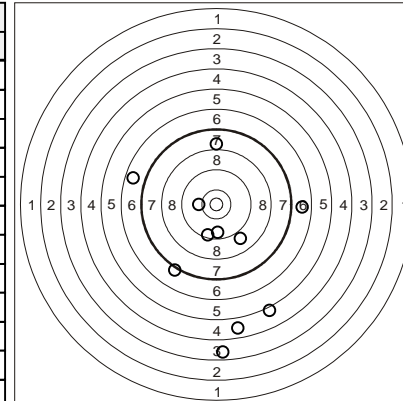

INDIVIDUAL SHOOTING RESULTS

Pentathlon World Cup Sofia, BULGARIA 2024 - WOMEN'S FINAL

Valeriya PERMYKINA (UKR)

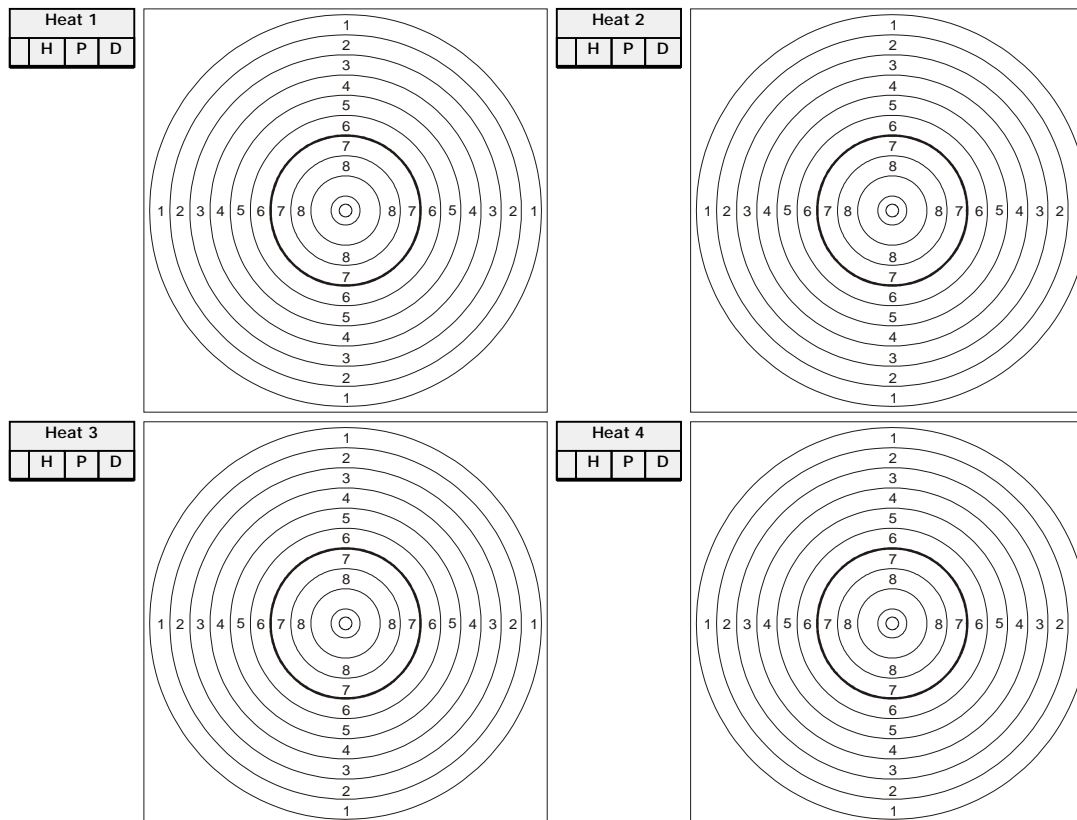

INDIVIDUAL SHOOTING RESULTS

Pentathlon World Cup Sofia, BULGARIA 2024 - WOMEN'S FINAL

Ieva SERAPINAITE (LTU)

