

# INDIVIDUAL SHOOTING RESULTS

OLYMPIC HOPES U19&U17, SPALA-POLAND 2023 - MEN U19 HEAT1

## GORZECHOWSKI Tytus (POL)

Heat 1			
	H	P	D
Tot	5/2/7	7,9	12,66
1	O	9,0	-
2	-	4,8	2,28
3	O	9,7	2,19
4	-	5,0	1,96
5	O	8,7	2,19
6	O	7,9	1,84
7	O	9,9	2,20

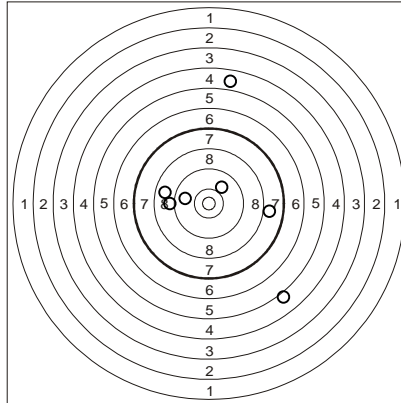

Heat 2			
	H	P	D
Tot	5/3/8	7,5	17,12
1	O	8,4	-
2	O	8,6	3,35
3	O	7,7	3,32
4	-	5,3	1,90
5	-	6,2	2,06
6	-	6,8	2,03
7	O	9,6	2,21
8	O	7,6	2,25

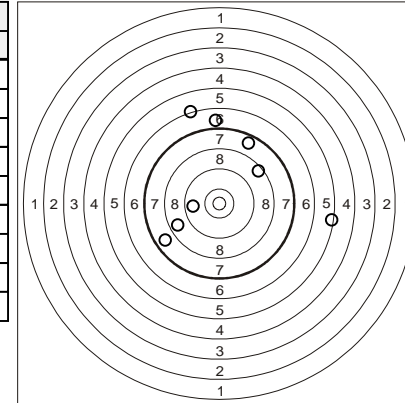

Heat 3			
	H	P	D
Tot	5/7/12	6,3	26,16
1	-	0,0	-
2	-	7,0	1,93
3	O	7,3	2,40
4	O	9,6	1,93
5	-	5,1	1,82
6	-	5,5	1,92
7	-	4,6	2,10
8	-	6,6	2,13
9	-	5,2	5,37
10	O	9,0	2,29
11	O	7,9	2,21
12	O	7,5	2,06

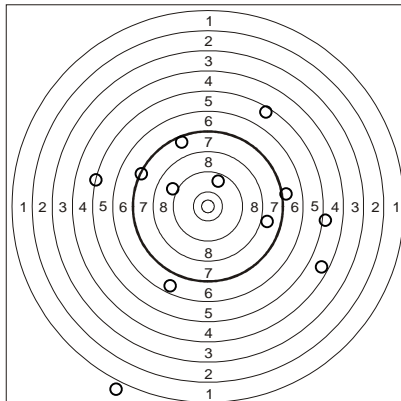

Heat 4			
	H	P	D
Tot	5/10/15	5,9	39,22
1	O	8,0	-
2	-	5,4	1,93
3	O	8,0	1,91
4	-	4,7	2,05
5	-	5,9	2,00
6	-	2,2	1,82
7	O	9,7	3,96
8	-	5,1	3,57
9	-	5,2	1,97
10	-	5,2	2,45
11	O	7,9	4,31
12	-	4,3	2,63
13	-	3,6	2,44
14	-	5,0	2,54
15	O	8,4	5,64

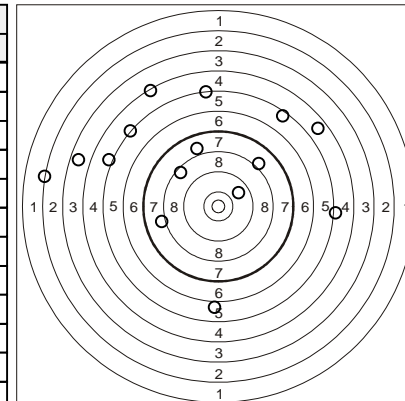

# INDIVIDUAL SHOOTING RESULTS

OLYMPIC HOPES U19&U17, SPALA-POLAND 2023 - MEN U19 HEAT1

LOCH Nikodem (POL)

Heat 1			
	H	P	D
Tot	5/8/13	5,4	31,85
1	O	8,2	-
2	-	1,4	2,97
3	-	5,0	2,75
4	-	4,5	3,21
5	-	3,1	2,59
6	-	3,9	2,85
7	O	8,6	2,33
8	O	7,5	2,63
9	-	4,5	2,87
10	O	8,1	2,38
11	-	6,0	2,31
12	-	1,0	2,49
13	O	8,7	2,47

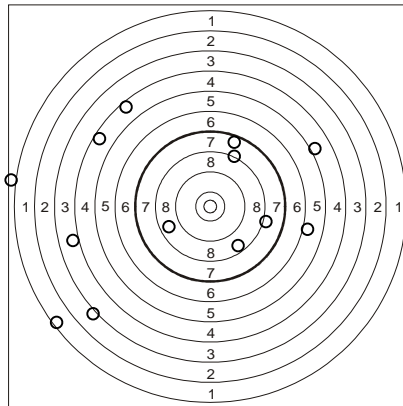

Heat 2			
	H	P	D
Tot	4/12/16	4,9	50,01
1	-	3,2	-
2	-	1,1	2,43
3	-	2,9	2,65
4	-	6,1	2,42
5	O	8,4	2,93
6	O	10,0	2,38
7	-	6,3	2,90
8	O	8,4	2,72
9	-	3,4	4,85
10	-	0,0	3,13
11	-	1,2	2,36
12	O	7,3	2,41
13	-	5,5	2,65
14	-	4,8	5,53
15	-	4,8	3,02
16	-	4,2	2,80

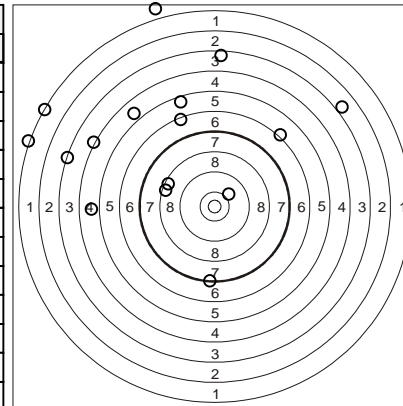

Heat 3			
	H	P	D
Tot	5/10/15	5,4	44,61
1	-	1,1	-
2	-	7,1	2,36
3	O	9,0	2,17
4	-	3,8	2,92
5	-	6,7	2,55
6	-	3,5	2,21
7	-	0,0	5,59
8	-	7,2	2,78
9	O	7,7	2,32
10	O	9,2	2,85
11	O	7,4	2,49
12	-	1,4	3,13
13	-	2,8	7,97
14	-	5,2	2,76
15	O	8,3	2,51

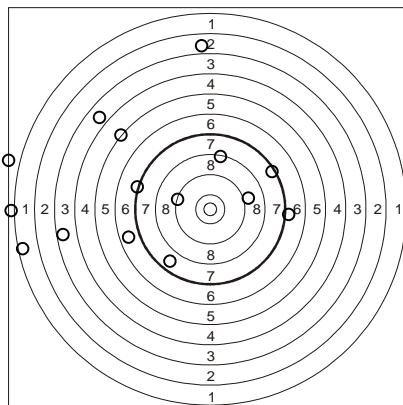

Heat 4			
	H	P	D
Tot	2/13/15	5,0	50,00
1	-	5,1	-
2	O	8,6	2,37
3	-	7,2	2,30
4	O	8,5	2,44
5	-	3,1	2,17
6	-	3,1	2,36
7	-	2,1	2,41
8	-	5,4	2,57
9	-	5,7	2,59
10	-	1,4	2,60
11	-	5,7	7,19
12	-	6,4	2,71
13	-	5,5	7,42
14	-	2,4	2,72
15	-	4,7	2,62

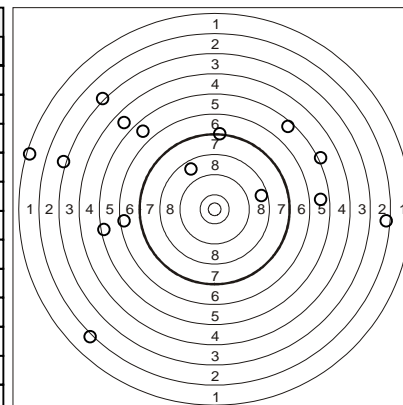

# INDIVIDUAL SHOOTING RESULTS

OLYMPIC HOPES U19&U17, SPALA-POLAND 2023 - MEN U19 HEAT1

## GEBHARDT Thorben (GER)

Heat 1			
	H	P	D
Tot	5/8/13	6,4	38,61
1	-	4,4	-
2	-	6,4	2,63
3	-	4,6	2,90
4	O	8,1	2,94
5	O	8,2	3,38
6	-	5,1	3,13
7	O	9,4	3,13
8	-	5,4	3,03
9	-	4,9	3,71
10	-	5,8	3,25
11	-	4,6	4,12
12	O	7,6	3,23
13	O	9,2	3,16

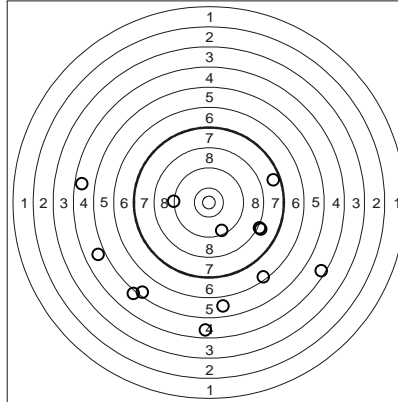

Heat 2			
	H	P	D
Tot	5/7/12	5,8	38,34
1	-	4,0	-
2	-	3,5	4,16
3	-	4,3	3,81
4	-	5,4	2,97
5	O	8,6	4,86
6	-	4,2	3,90
7	-	6,4	3,44
8	O	9,2	3,64
9	O	7,5	3,20
10	-	0,0	2,52
11	O	7,3	3,19
12	O	9,1	2,65

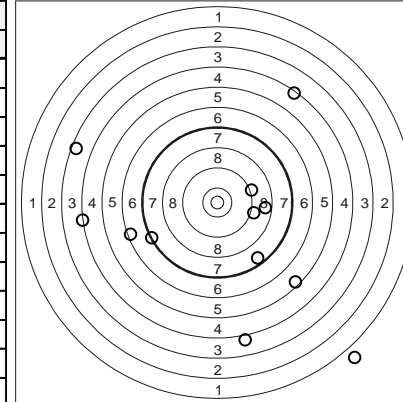

Heat 3			
	H	P	D
Tot	4/13/17	5,4	50,02
1	-	0,0	-
2	-	5,7	3,07
3	O	8,0	3,00
4	-	5,6	3,24
5	-	6,4	2,84
6	-	4,4	2,70
7	-	4,8	3,25
8	O	7,8	3,01
9	-	7,0	3,05
10	-	1,7	3,02
11	O	8,7	2,89
12	-	4,5	2,53
13	-	2,0	3,65
14	-	6,5	2,85
15	O	7,8	3,03
16	-	3,7	2,82
17	-	7,0	3,54

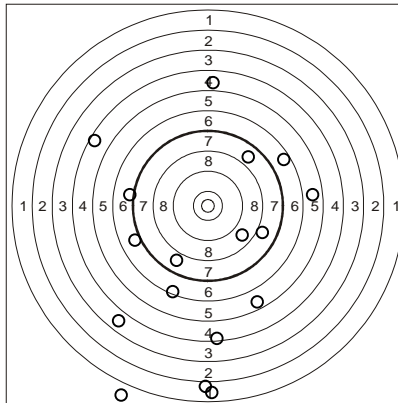

Heat 4			
	H	P	D
Tot	3/9/12	5,6	49,99
1	-	4,7	-
2	-	7,1	3,04
3	-	1,3	2,93
4	O	8,5	2,96
5	O	8,4	3,82
6	-	6,2	7,79
7	-	5,8	9,04
8	-	5,3	3,52
9	-	2,3	3,61
10	O	9,7	3,38
11	-	2,6	6,79
12	-	5,8	2,83

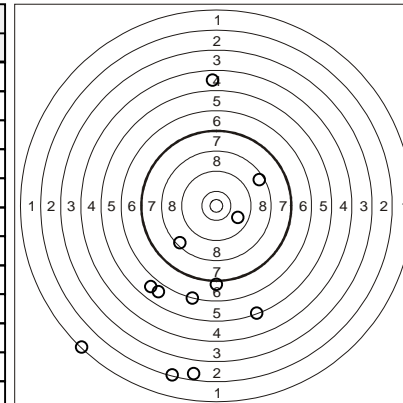

# INDIVIDUAL SHOOTING RESULTS

OLYMPIC HOPES U19&U17, SPALA-POLAND 2023 - MEN U19 HEAT1

## HERCZEG Aron (HUN)

Heat 1			
	H	P	D
Tot	5/11/16	5,7	37,28
1	O	8,9	-
2	-	0,0	2,64
3	-	4,9	4,43
4	-	1,6	2,43
5	-	4,3	2,42
6	-	1,9	1,99
7	O	10,3	2,55
8	O	8,6	1,91
9	-	5,5	2,00
10	-	3,8	2,17
11	-	1,8	2,30
12	-	6,6	2,35
13	-	7,0	2,51
14	O	10,4	2,46
15	-	4,5	2,59
16	O	10,5	2,53

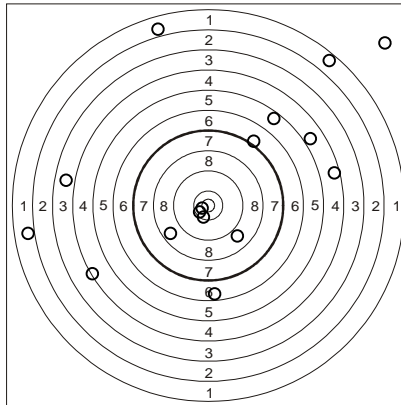

Heat 2			
	H	P	D
Tot	5/3/8	7,3	15,81
1	O	9,2	-
2	-	5,8	2,13
3	-	4,7	2,21
4	O	7,4	2,32
5	O	9,9	2,31
6	O	9,6	2,22
7	-	2,4	2,25
8	O	9,1	2,37

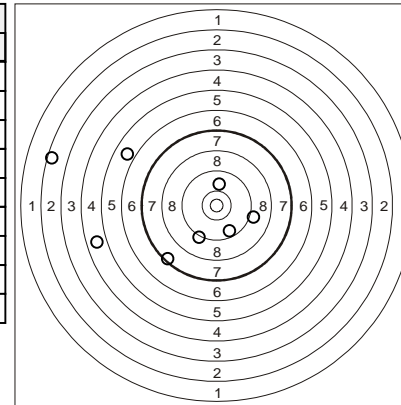

Heat 3			
	H	P	D
Tot	5/3/8	7,2	15,75
1	-	4,9	-
2	O	10,0	2,38
3	O	8,1	2,31
4	-	7,0	1,96
5	-	3,6	3,05
6	O	8,5	2,18
7	O	7,3	1,94
8	O	8,3	1,93

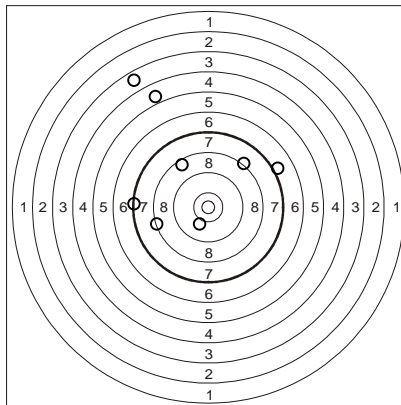

Heat 4			
	H	P	D
Tot			
1			
2			
3			
4			
5			
6			
7			
8			

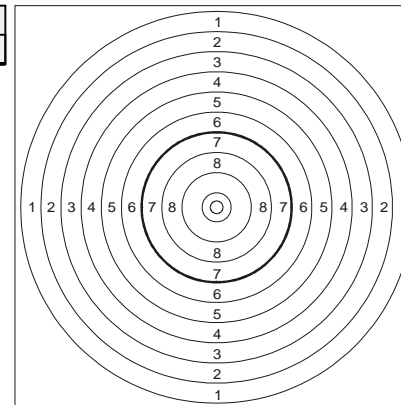

# INDIVIDUAL SHOOTING RESULTS

OLYMPIC HOPES U19&U17, SPALA-POLAND 2023 - MEN U19 HEAT1

## UIFFINGER Pius (GER)

Heat 1			
	H	P	D
Tot	5/2/7	8,0	11,72
1	O	7,9	-
2	O	8,2	2,01
3	O	7,4	1,90
4	O	9,9	1,84
5	-	5,6	1,94
6	-	6,5	1,92
7	O	10,2	2,11

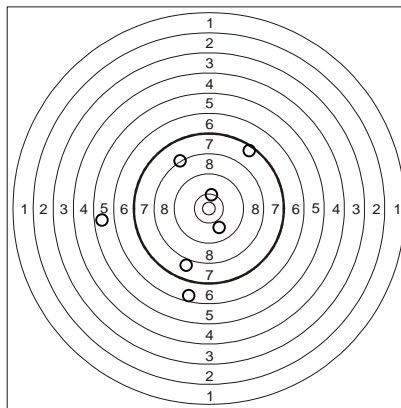

Heat 2			
	H	P	D
Tot	5/1/6	8,9	10,29
1	-	6,3	-
2	O	9,4	2,31
3	O	9,5	1,94
4	O	9,8	2,00
5	O	9,1	2,03
6	O	9,0	2,01

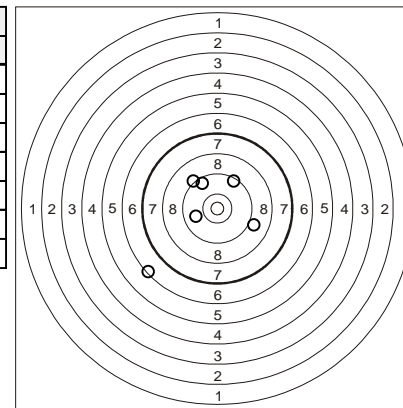

Heat 3			
	H	P	D
Tot	5/6/11	7,1	19,31
1	-	2,2	-
2	-	4,9	2,32
3	O	8,0	1,90
4	O	9,0	1,92
5	-	6,2	1,89
6	-	7,1	1,79
7	-	7,2	1,89
8	O	8,3	1,82
9	-	7,0	1,92
10	O	9,5	1,98
11	O	8,9	1,88

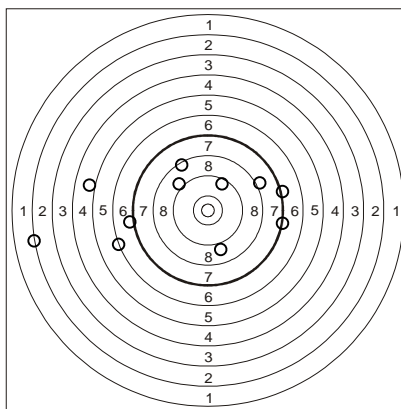

Heat 4			
	H	P	D
Tot	5/0/5	8,3	8,51
1	O	9,7	-
2	O	7,7	2,12
3	O	7,6	2,02
4	O	9,0	1,93
5	O	7,6	2,44

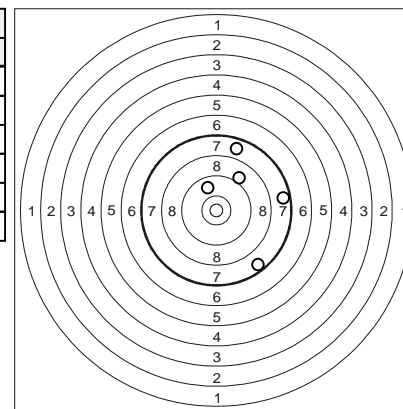

# INDIVIDUAL SHOOTING RESULTS

OLYMPIC HOPES U19&U17, SPALA-POLAND 2023 - MEN U19 HEAT1

## KRATA Marcel (POL)

Heat 1			
	H	P	D
Tot	5/4/9	7,8	17,48
1	O	8,8	-
2	-	6,5	2,12
3	O	8,9	2,90
4	-	6,5	2,14
5	O	9,7	1,97
6	-	6,9	2,16
7	O	8,7	2,12
8	-	5,6	2,00
9	O	8,6	2,07

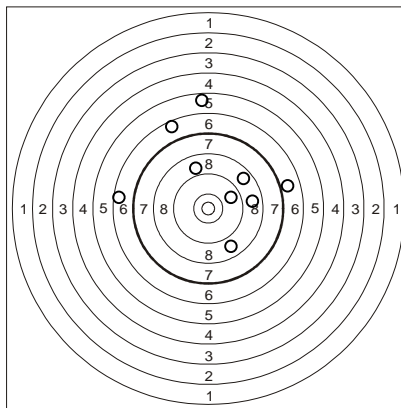

Heat 2			
	H	P	D
Tot	5/4/9	7,0	19,39
1	O	7,3	-
2	-	6,6	2,35
3	-	5,2	2,55
4	-	4,7	2,23
5	O	9,7	2,56
6	-	6,3	2,51
7	O	7,3	2,51
8	O	8,1	2,29
9	O	7,6	2,39

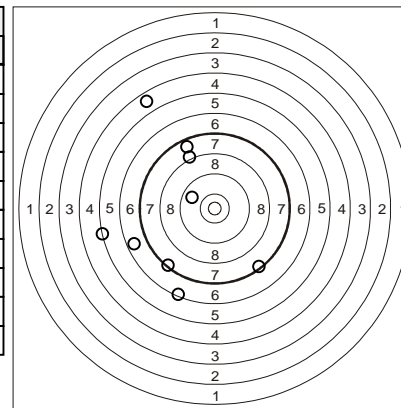

Heat 3			
	H	P	D
Tot	5/3/8	7,6	14,92
1	O	7,5	-
2	-	5,4	2,28
3	O	8,0	2,06
4	-	7,0	2,12
5	O	7,7	2,11
6	-	6,0	1,95
7	O	8,9	2,20
8	O	9,9	2,20

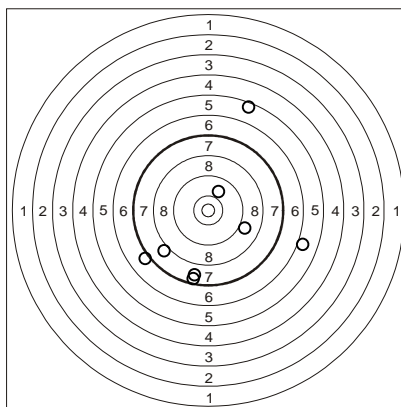

Heat 4			
	H	P	D
Tot	5/4/9	6,7	19,57
1	-	1,5	-
2	O	7,5	2,61
3	-	6,6	1,95
4	O	8,1	1,92
5	-	4,6	2,44
6	O	9,6	2,49
7	-	7,1	3,52
8	O	7,4	2,42
9	O	7,5	2,22

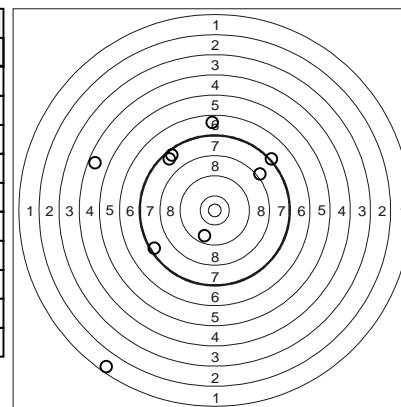

# INDIVIDUAL SHOOTING RESULTS

OLYMPIC HOPES U19&U17, SPALA-POLAND 2023 - MEN U19 HEAT1

## KANTOR Benedek (HUN)

Heat 1			
	H	P	D
Tot	5/2/7	7,3	11,20
1	O	7,8	-
2	-	5,3	1,99
3	O	8,8	1,85
4	O	9,4	1,77
5	-	1,3	1,81
6	O	9,8	1,95
7	O	8,8	1,83

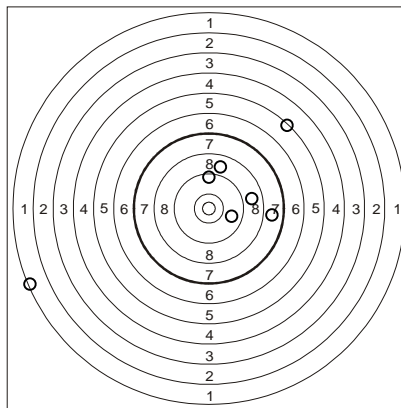

Heat 2			
	H	P	D
Tot	5/6/11	6,7	18,04
1	-	2,0	-
2	O	8,8	1,93
3	-	5,7	1,90
4	-	4,5	1,76
5	-	7,1	1,81
6	O	8,3	1,84
7	-	5,6	1,69
8	O	9,2	1,76
9	O	9,6	1,76
10	-	4,4	1,74
11	O	8,9	1,85

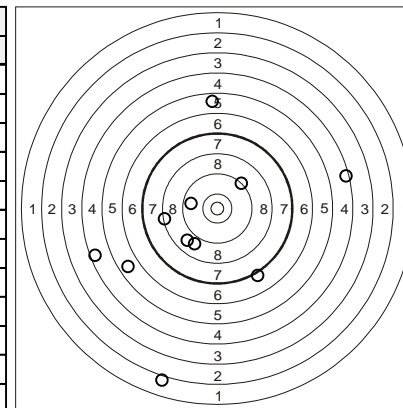

Heat 3			
	H	P	D
Tot	5/7/12	6,8	19,13
1	O	9,3	-
2	-	5,9	1,86
3	O	8,1	1,82
4	O	9,7	1,79
5	-	2,8	1,63
6	-	6,8	1,62
7	-	5,8	1,71
8	-	6,3	1,70
9	O	10,3	1,72
10	-	2,1	1,63
11	-	6,3	1,90
12	O	8,0	1,75

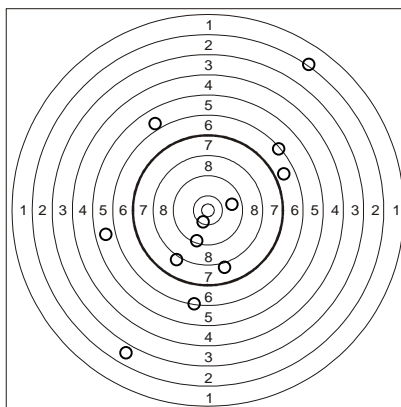

Heat 4			
	H	P	D

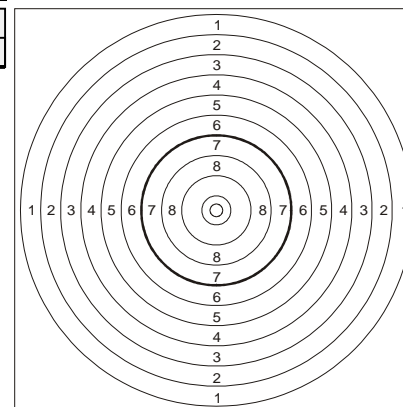

# INDIVIDUAL SHOOTING RESULTS

OLYMPIC HOPES U19&U17, SPALA-POLAND 2023 - MEN U19 HEAT1

KANTOR Vince (HUN)

Heat 1			
	H	P	D
Tot	5/2/7	7,8	12,13
1	O	9,9	-
2	O	7,6	2,17
3	O	10,6	2,09
4	O	7,3	1,99
5	-	5,8	1,85
6	-	5,5	2,02
7	O	7,6	2,01

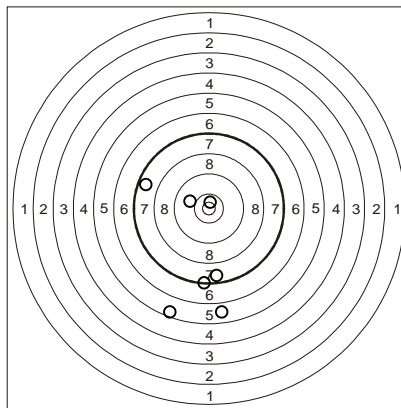

Heat 2			
	H	P	D
Tot	5/7/12	5,9	21,71
1	-	7,2	-
2	-	5,4	2,20
3	O	8,0	2,24
4	-	2,5	2,01
5	-	5,9	2,21
6	O	9,1	1,98
7	O	9,6	1,79
8	-	4,4	1,79
9	-	0,0	2,07
10	O	7,7	1,75
11	-	2,6	1,83
12	O	8,7	1,84

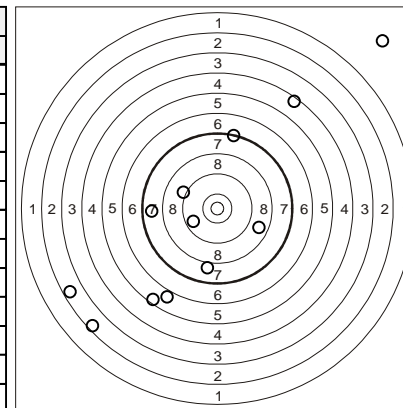

Heat 3			
	H	P	D
Tot	5/7/12	7,0	23,15
1	-	5,6	-
2	-	6,5	2,25
3	O	8,6	2,21
4	O	8,1	1,99
5	-	5,1	1,87
6	-	5,8	2,20
7	O	10,2	2,02
8	O	9,4	2,03
9	-	5,7	2,13
10	-	5,5	1,96
11	-	4,5	2,39
12	O	8,8	2,10

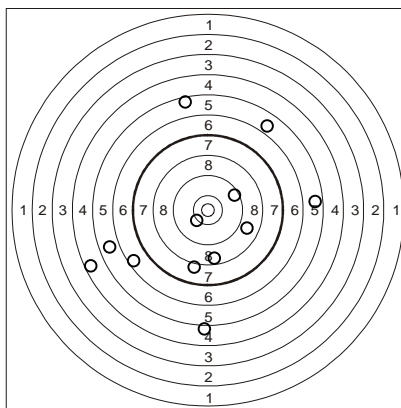

Heat 4			
	H	P	D

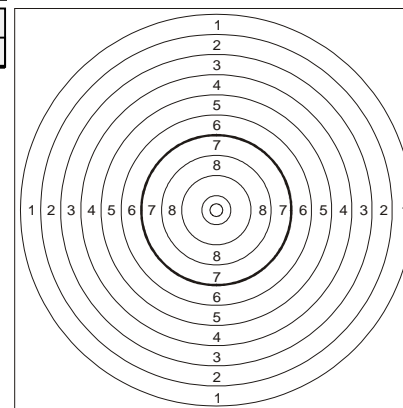



# INDIVIDUAL SHOOTING RESULTS

OLYMPIC HOPES U19&U17, SPALA-POLAND 2023 - MEN U19 HEAT1

**RICHEL Jaden (GER)**

Heat 1			
	H	P	D
Tot	5/2/7	7,5	12,03
1	-	4,6	-
2	O	7,5	2,13
3	O	8,0	1,99
4	O	8,0	1,85
5	-	6,4	2,13
6	O	9,3	1,91
7	O	8,6	2,02

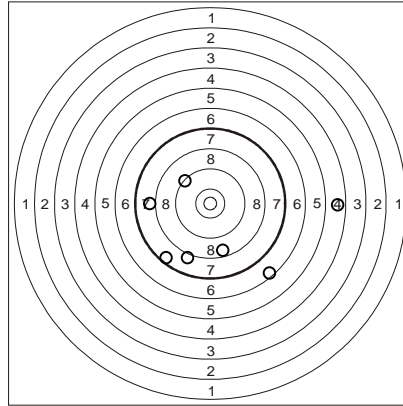

Heat 2			
	H	P	D
Tot	5/3/8	7,7	15,53
1	-	5,2	-
2	-	6,7	2,39
3	-	7,2	2,42
4	O	8,6	2,65
5	O	7,4	2,10
6	O	8,6	2,06
7	O	9,6	1,88
8	O	8,6	2,03

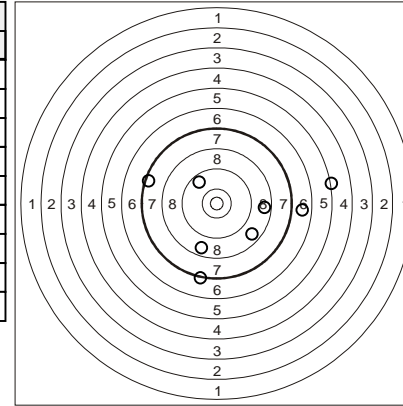

Heat 3			
	H	P	D
Tot	5/1/6	8,4	9,92
1	-	6,1	-
2	O	9,3	2,22
3	O	9,6	1,93
4	O	7,5	1,92
5	O	9,7	1,87
6	O	8,2	1,98

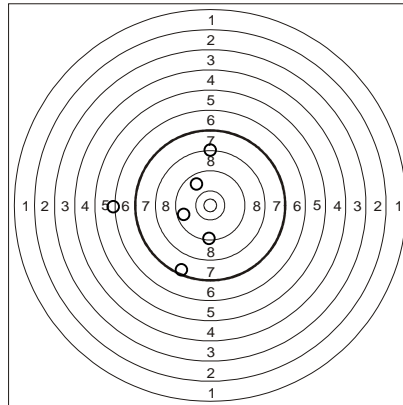

Heat 4			
	H	P	D
Tot	5/2/7	7,7	15,79
1	-	5,6	-
2	-	6,6	2,26
3	O	8,6	2,37
4	O	8,3	2,37
5	O	7,5	2,92
6	O	7,7	2,57
7	O	9,3	3,30

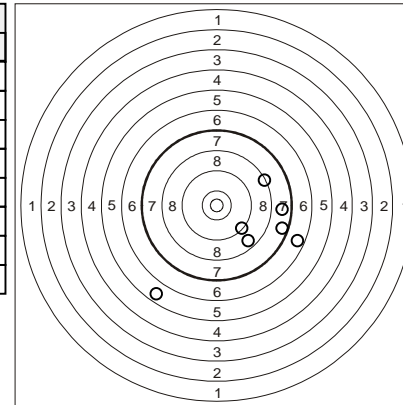

# INDIVIDUAL SHOOTING RESULTS

OLYMPIC HOPES U19&U17, SPALA-POLAND 2023 - MEN U19 HEAT1

CHRIST Oskar (GER)

Heat 1			
	H	P	D
Tot	5/8/13	6,6	23,22
1	-	7,0	-
2	O	8,5	2,31
3	O	9,7	2,00
4	O	7,4	1,86
5	-	7,0	1,67
6	-	5,1	1,88
7	-	7,1	1,98
8	-	4,2	1,78
9	-	6,1	1,87
10	O	8,5	1,92
11	-	3,9	2,02
12	-	1,2	1,93
13	O	10,2	2,00

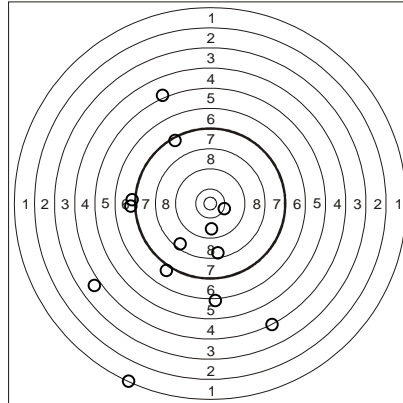

Heat 2			
	H	P	D
Tot	5/7/12	6,0	21,78
1	-	0,0	-
2	O	10,1	2,18
3	-	6,5	1,67
4	-	5,4	1,88
5	O	8,6	2,01
6	O	7,3	1,90
7	-	3,7	1,84
8	-	3,7	1,83
9	O	7,9	1,88
10	-	6,8	1,95
11	-	3,8	2,70
12	O	7,6	1,94

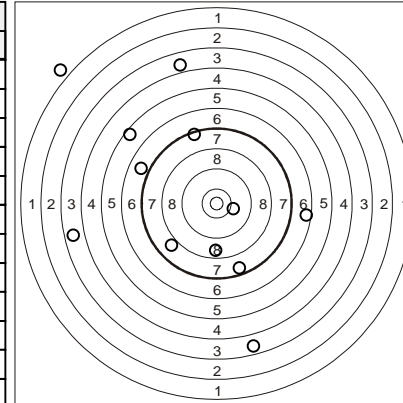

Heat 3			
	H	P	D
Tot	5/3/8	7,1	12,73
1	O	8,5	-
2	O	8,6	1,84
3	O	7,8	1,72
4	-	3,3	1,71
5	-	5,3	1,72
6	-	3,7	1,83
7	O	9,9	2,09
8	O	9,4	1,82

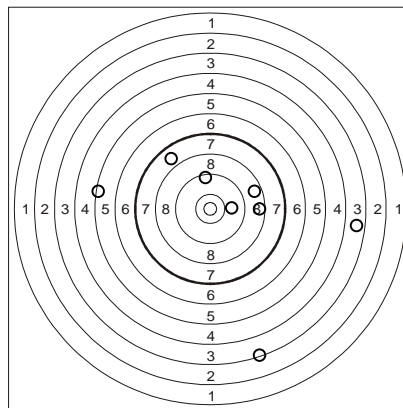

Heat 4			
	H	P	D
Tot	5/10/15	5,7	31,03
1	-	0,0	-
2	-	0,0	2,71
3	-	3,2	2,21
4	O	8,6	2,30
5	-	5,2	1,93
6	-	5,2	2,15
7	-	6,8	2,18
8	-	6,8	2,22
9	O	9,9	2,23
10	-	0,0	2,11
11	O	8,9	2,13
12	-	6,8	1,90
13	-	5,2	2,12
14	O	9,9	2,52
15	O	9,6	2,32

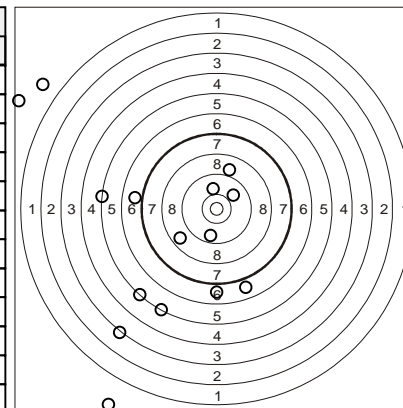

# INDIVIDUAL SHOOTING RESULTS

OLYMPIC HOPES U19&U17, SPALA-POLAND 2023 - MEN U19 HEAT1

## SCHNEIDER Felix (GER)

Heat 1			
	H	P	D
Tot	5/9/14	5,8	31,53
1	-	2,0	-
2	O	9,8	2,40
3	-	6,0	2,03
4	-	1,2	2,22
5	-	3,0	1,98
6	O	10,4	2,82
7	O	8,4	2,52
8	-	6,7	2,23
9	-	6,0	1,92
10	-	1,5	4,32
11	O	9,6	2,30
12	-	7,2	2,14
13	-	2,0	2,37
14	O	7,3	2,28

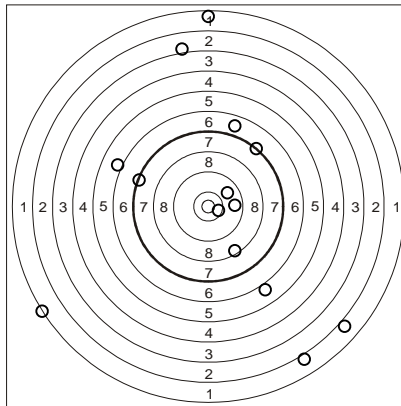

Heat 2			
	H	P	D
Tot	3/17/20	4,7	49,99
1	-	6,6	-
2	-	5,4	2,73
3	-	3,0	2,71
4	-	4,7	2,56
5	O	9,0	4,64
6	-	4,5	2,17
7	-	4,9	2,27
8	-	6,9	2,10
9	-	1,4	2,15
10	O	9,6	2,54
11	-	4,6	2,18
12	-	1,9	2,23
13	-	2,4	2,05
14	-	0,0	2,03
15	-	5,0	2,39
16	O	7,4	2,86
17	-	6,6	2,72
18	-	2,1	2,31
19	-	6,4	3,03
20	-	1,8	2,72

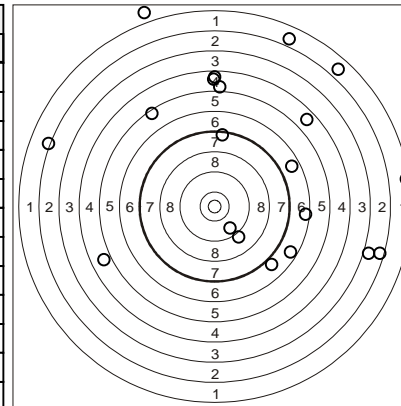

Heat 3			
	H	P	D
Tot	5/6/11	6,8	26,20
1	-	7,2	-
2	-	6,3	2,68
3	O	7,8	2,69
4	O	8,7	2,59
5	O	8,6	2,58
6	-	3,0	2,50
7	O	7,6	2,46
8	-	5,9	2,22
9	-	4,7	2,42
10	-	6,7	2,39
11	O	8,6	3,67

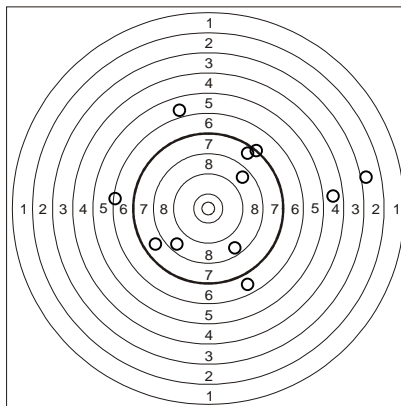

Heat 4			
	H	P	D
Tot	2/16/18	5,2	49,99
1	-	6,6	-
2	-	5,8	3,07
3	-	5,6	3,19
4	-	5,8	2,56
5	-	7,1	2,57
6	-	6,6	4,76
7	-	4,7	2,60
8	O	7,5	2,35
9	-	0,0	3,02
10	-	1,9	2,45
11	-	2,1	2,31
12	-	6,5	2,56
13	O	8,1	4,12
14	-	6,1	2,24
15	-	3,0	2,54

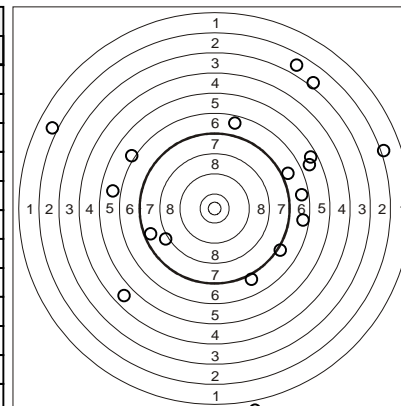

# INDIVIDUAL SHOOTING RESULTS

OLYMPIC HOPES U19&U17, SPALA-POLAND 2023 - MEN U19 HEAT1

**HARGADEN Jamie (IRL)**

Heat 1			
	H	P	D
Tot	5/5/10	6,6	16,98
1	-	6,9	-
2	-	3,3	1,99
3	-	3,5	1,84
4	-	2,7	1,94
5	O	9,0	1,79
6	O	8,3	2,02
7	-	6,3	1,75
8	O	8,3	1,89
9	O	9,0	1,82
10	O	8,8	1,94

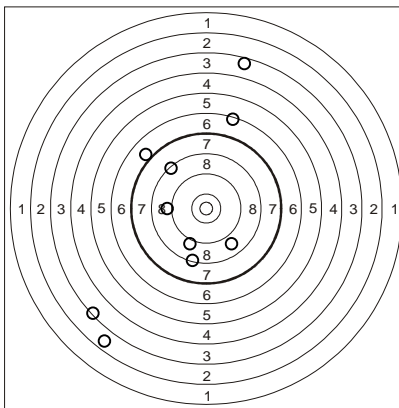

Heat 2			
	H	P	D
Tot	5/0/5	8,7	6,74
1	O	8,2	-
2	O	10,0	1,72
3	O	8,3	1,69
4	O	9,2	1,63
5	O	8,0	1,70

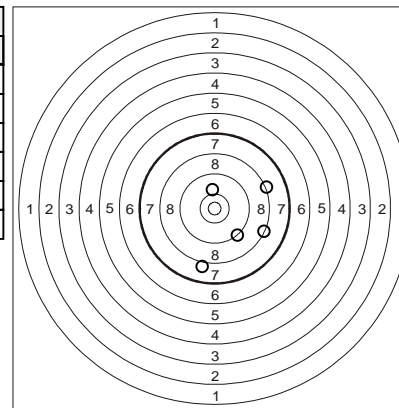

Heat 3			
	H	P	D
Tot	5/10/15	6,9	24,26
1	-	5,7	-
2	-	6,4	1,83
3	-	5,7	1,73
4	-	6,4	1,69
5	O	10,2	1,72
6	-	6,1	1,73
7	O	9,5	1,80
8	O	7,5	1,60
9	-	5,4	1,62
10	-	7,0	1,64
11	O	9,1	1,70
12	-	6,5	1,72
13	-	5,7	1,72
14	-	3,9	1,84
15	O	8,6	1,92

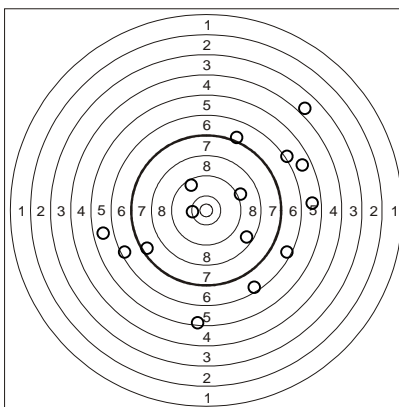

Heat 4			
	H	P	D
Tot	5/12/17	6,1	28,58
1	-	4,4	-
2	-	6,1	1,81
3	-	6,2	1,82
4	O	9,6	1,71
5	O	7,9	1,74
6	-	3,1	1,72
7	-	4,1	1,78
8	O	10,3	1,83
9	-	2,1	1,80
10	-	4,6	1,73
11	-	5,4	1,69
12	O	8,4	1,73
13	-	5,7	1,87
14	-	6,8	1,76
15	-	6,4	1,84
16	-	4,4	1,91
17	O	8,5	1,84

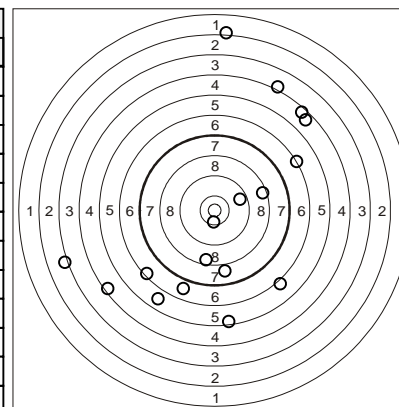

# INDIVIDUAL SHOOTING RESULTS

OLYMPIC HOPES U19&U17, SPALA-POLAND 2023 - MEN U19 HEAT1

## KOVALCHUK Maksym (UKR)

Heat 1			
	H	P	D
Tot	5/4/9	7,5	16,67
1	O	8,9	-
2	O	9,5	2,25
3	O	7,8	2,29
4	-	4,6	2,07
5	-	6,4	1,91
6	-	7,2	2,21
7	O	7,6	1,96
8	-	6,3	1,86
9	O	9,4	2,12

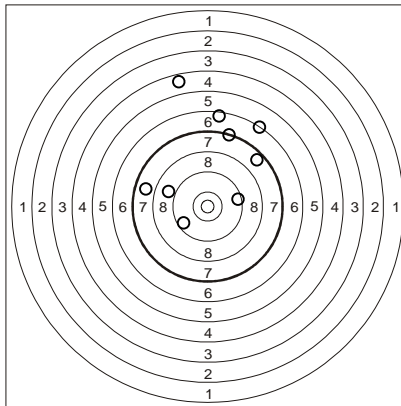

Heat 2			
	H	P	D
Tot	5/0/5	8,6	8,17
1	O	7,7	-
2	O	9,7	2,18
3	O	8,2	1,83
4	O	8,7	2,07
5	O	8,8	2,09

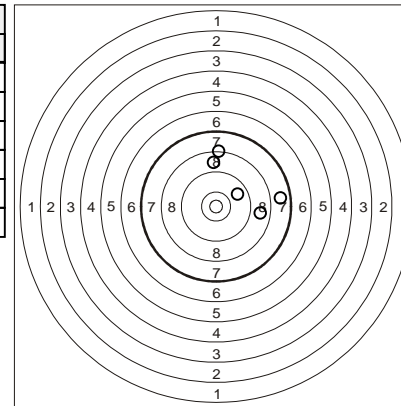

Heat 3			
	H	P	D
Tot	5/2/7	8,3	11,34
1	-	6,6	-
2	-	6,5	2,05
3	O	9,9	1,92
4	O	8,4	1,93
5	O	8,7	1,82
6	O	10,0	1,83
7	O	8,2	1,79

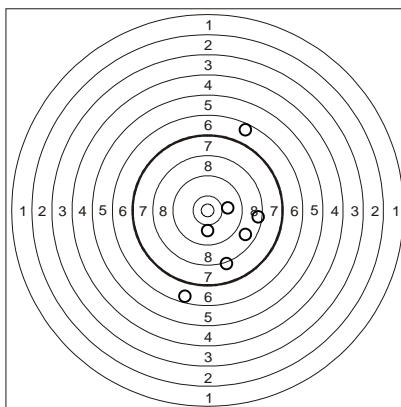

Heat 4			
	H	P	D
Tot	5/3/8	7,9	12,19
1	O	8,5	-
2	-	5,3	1,90
3	O	10,1	1,72
4	O	9,1	1,71
5	-	4,4	1,65
6	-	6,6	1,76
7	O	9,0	1,64
8	O	10,0	1,81

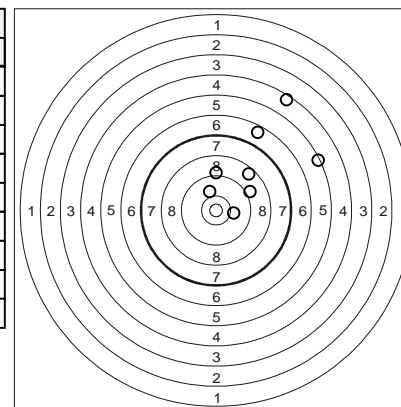

# INDIVIDUAL SHOOTING RESULTS

OLYMPIC HOPES U19&U17, SPALA-POLAND 2023 - MEN U19 HEAT1

**BODNAR Maksymilian (POL)**

Heat 1			
	H	P	D
Tot	5/4/9	7,7	16,97
1	O	8,8	-
2	O	8,2	2,18
3	-	7,1	2,10
4	-	7,0	2,17
5	O	7,6	1,90
6	-	7,1	2,25
7	-	6,8	2,13
8	O	9,4	2,00
9	O	7,3	2,24

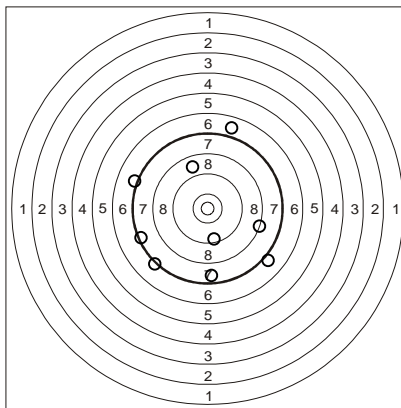

Heat 2			
	H	P	D
Tot	5/4/9	7,3	16,47
1	O	8,1	-
2	-	4,8	2,09
3	O	9,1	2,03
4	-	5,2	2,13
5	O	9,4	1,93
6	O	8,3	1,97
7	-	6,1	1,97
8	-	7,1	2,13
9	O	8,0	2,22

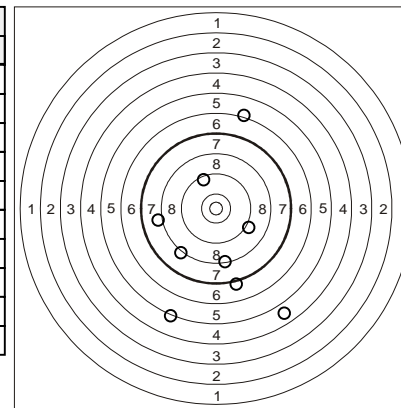

Heat 3			
	H	P	D
Tot	5/4/9	7,6	16,52
1	-	2,1	-
2	-	7,1	2,04
3	O	9,2	1,88
4	O	8,1	1,97
5	-	7,1	2,14
6	-	7,2	2,07
7	O	10,1	2,00
8	O	10,1	2,04
9	O	7,4	2,38

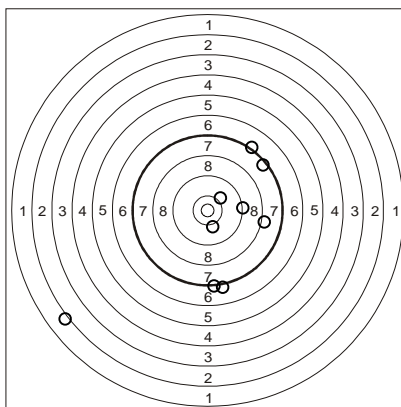

Heat 4			
	H	P	D
Tot	5/1/6	8,6	9,60
1	O	7,8	-
2	O	9,5	1,81
3	O	8,9	1,77
4	O	9,2	1,99
5	-	5,7	2,02
6	O	10,7	2,01

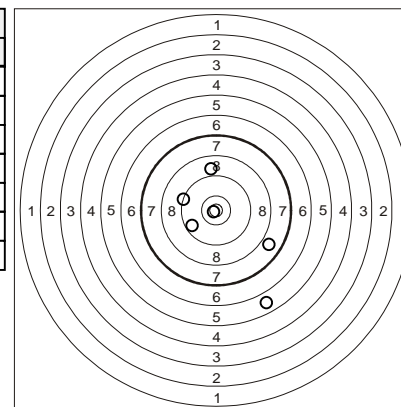

# INDIVIDUAL SHOOTING RESULTS

OLYMPIC HOPES U19&U17, SPALA-POLAND 2023 - MEN U19 HEAT1

## BUCEVICIUS Simas (LTU)

Heat 1			
	H	P	D
Tot	4/16/20	5,6	50,00
1	-	6,2	-
2	-	7,0	2,27
3	-	4,5	2,59
4	-	3,5	2,35
5	-	4,8	2,29
6	-	2,9	2,36
7	-	6,4	2,34
8	-	5,5	1,87
9	-	3,4	1,96
10	-	0,0	2,39
11	-	6,0	3,43
12	-	5,9	4,47
13	0	7,9	2,94
14	-	5,5	2,49
15	-	2,3	2,34
16	-	6,7	3,04
17	-	4,9	2,58
18	0	9,8	2,67
19	0	8,4	2,42
20	0	9,4	2,06

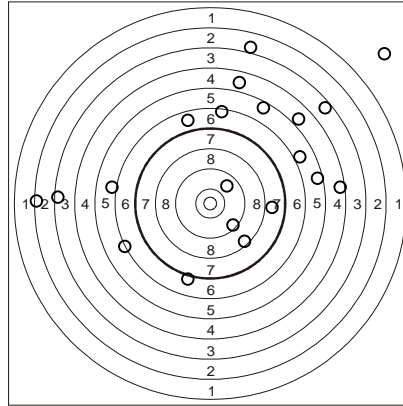

Heat 2			
	H	P	D
Tot	5/1/6	7,3	12,09
1	-	1,0	-
2	0	7,7	2,72
3	0	9,5	2,43
4	0	8,1	2,39
5	0	9,6	2,34
6	0	7,8	2,21

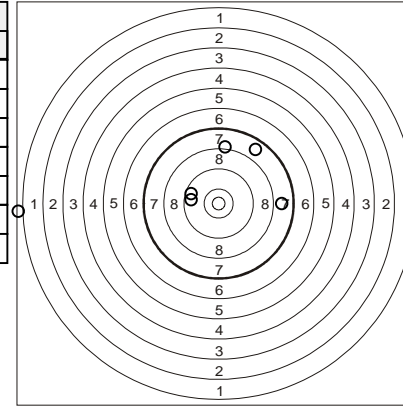

Heat 3			
	H	P	D
Tot	5/4/9	7,5	21,23
1	-	6,6	-
2	-	4,2	2,61
3	-	6,3	2,54
4	0	7,9	2,52
5	0	9,2	2,32
6	0	7,5	2,49
7	0	9,0	2,86
8	-	6,4	2,81
9	0	10,3	3,08

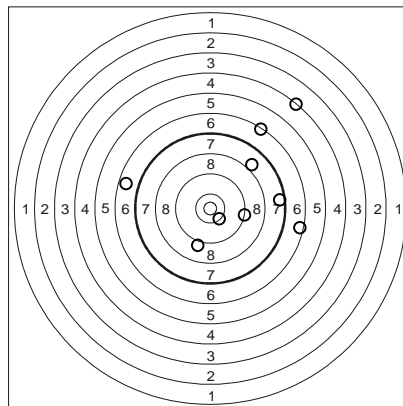

Heat 4			
	H	P	D
Tot	5/6/11	6,6	23,84
1	-	5,9	-
2	-	4,5	2,31
3	-	4,8	2,30
4	-	7,1	2,27
5	-	5,3	2,50
6	0	8,4	2,36
7	0	9,0	2,29
8	0	7,4	2,22
9	0	7,4	2,43
10	-	5,2	2,65
11	0	7,6	2,51

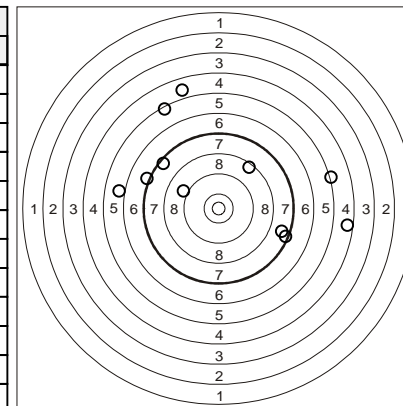

# INDIVIDUAL SHOOTING RESULTS

OLYMPIC HOPES U19&U17, SPALA-POLAND 2023 - MEN U19 HEAT1

**HEDLEY Jacob (GBR)**

Heat 1			
	H	P	D
Tot	5/5/10	6,8	16,92
1	-	6,1	-
2	O	7,6	2,04
3	-	3,1	1,74
4	O	9,0	1,79
5	O	7,8	1,71
6	-	6,7	1,92
7	O	9,3	1,81
8	-	4,6	1,91
9	-	5,2	2,18
10	O	8,6	1,82

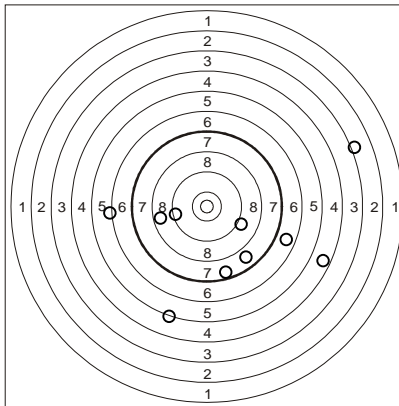

Heat 2			
	H	P	D
Tot	5/2/7	7,7	11,13
1	-	4,6	-
2	O	9,4	1,94
3	-	6,5	1,88
4	O	7,4	1,90
5	O	8,6	1,84
6	O	7,8	1,83
7	O	9,3	1,74

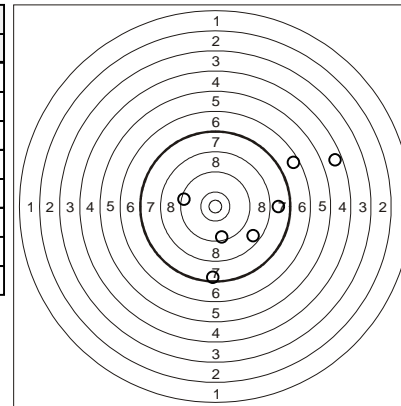

Heat 3			
	H	P	D
Tot	5/6/11	6,5	18,49
1	-	5,9	-
2	-	4,7	1,90
3	-	6,3	1,83
4	O	8,0	1,72
5	-	3,4	1,82
6	-	4,4	1,82
7	-	6,3	2,00
8	O	8,8	1,91
9	O	9,0	1,93
10	O	7,4	1,82
11	O	7,6	1,74

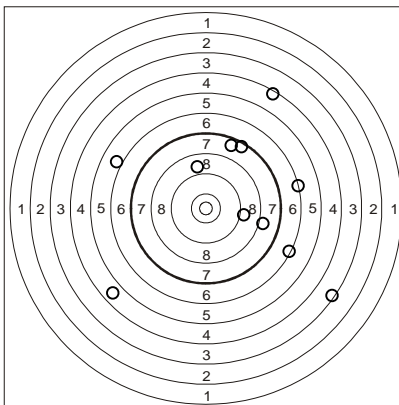

Heat 4			
	H	P	D
Tot	5/7/12	6,7	24,70
1	-	3,1	-
2	-	2,4	1,96
3	O	9,0	1,84
4	O	9,0	1,91
5	O	10,6	1,88
6	-	6,4	2,02
7	-	4,2	1,95
8	-	6,3	2,42
9	-	5,4	4,31
10	O	8,1	2,04
11	-	6,0	2,01
12	O	9,8	2,36

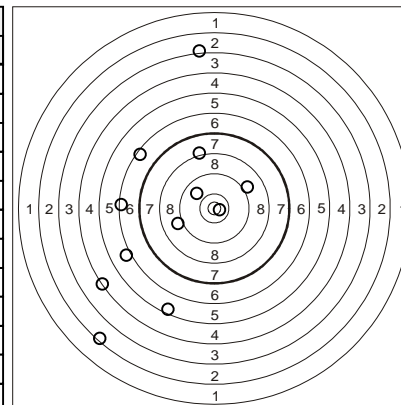



# INDIVIDUAL SHOOTING RESULTS

OLYMPIC HOPES U19&U17, SPALA-POLAND 2023 - MEN U19 HEAT1

**RYBAK Oleh (UKR)**

Heat 1			
	H	P	D
Tot	5/8/13	6,7	18,72
1	0	9,5	-
2	-	7,2	1,52
3	-	5,7	1,47
4	0	9,7	1,55
5	-	6,7	1,41
6	0	8,5	1,61
7	-	5,3	1,49
8	-	6,0	1,34
9	0	8,9	1,38
10	-	3,5	1,92
11	-	3,5	1,64
12	-	3,8	1,84
13	0	8,6	1,55

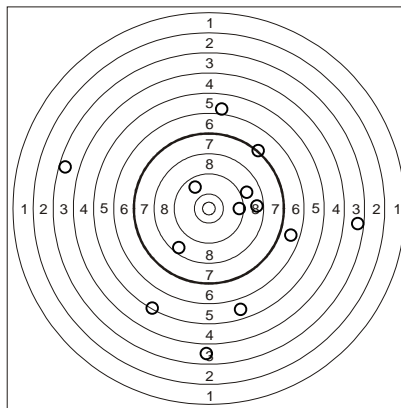

Heat 2			
	H	P	D
Tot	5/5/10	6,9	15,52
1	-	3,5	-
2	-	4,3	2,01
3	-	6,4	1,56
4	0	8,2	2,05
5	-	6,1	1,78
6	0	8,5	1,47
7	-	4,5	2,03
8	0	7,7	1,43
9	0	8,8	1,57
10	0	10,5	1,62

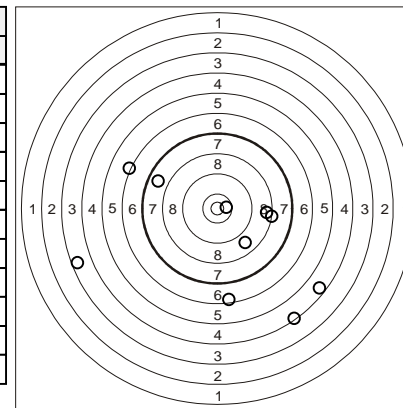

Heat 3			
	H	P	D
Tot	5/7/12	6,5	16,98
1	-	5,7	-
2	-	5,7	1,54
3	0	7,6	1,50
4	-	1,7	1,66
5	0	8,2	1,64
6	-	6,1	1,35
7	-	7,1	1,59
8	0	9,9	1,33
9	0	10,0	1,49
10	-	3,6	1,56
11	-	2,5	1,73
12	0	10,0	1,59

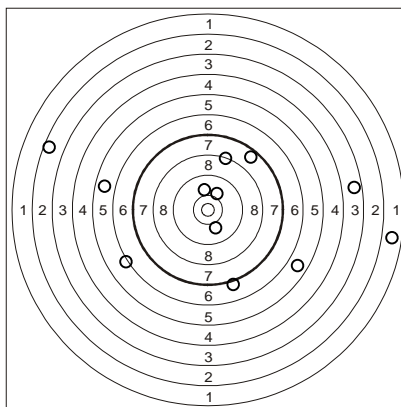

Heat 4			
	H	P	D
Tot	5/1/6	7,4	7,21
1	0	8,4	-
2	0	9,6	1,48
3	-	1,8	1,33
4	0	7,5	1,45
5	0	8,8	1,60
6	0	8,4	1,35

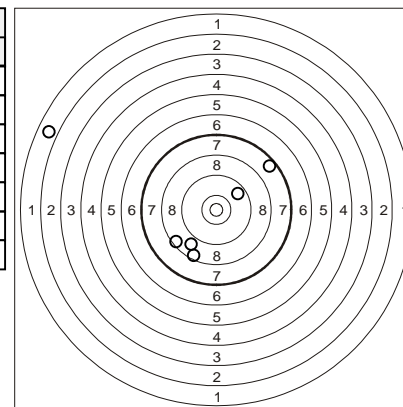

# INDIVIDUAL SHOOTING RESULTS

OLYMPIC HOPES U19&U17, SPALA-POLAND 2023 - MEN U19 HEAT1

## GALLIGAN Peter (IRL)

Heat 1			
	H	P	D
Tot	5/6/11	7,1	23,12
1	-	4,5	-
2	-	4,2	2,31
3	O	9,7	2,21
4	O	10,3	2,23
5	-	7,0	2,95
6	-	6,5	2,27
7	O	7,7	2,25
8	O	7,7	2,23
9	-	4,7	2,12
10	-	5,7	2,14
11	O	9,8	2,41

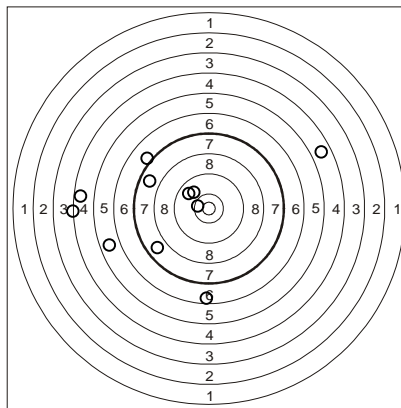

Heat 2			
	H	P	D
Tot	5/5/10	7,2	20,26
1	O	9,2	-
2	-	6,2	2,21
3	O	8,9	2,27
4	O	7,5	2,32
5	-	6,6	2,22
6	O	7,6	2,20
7	-	6,5	2,16
8	-	5,7	2,12
9	-	4,9	2,38
10	O	8,7	2,38

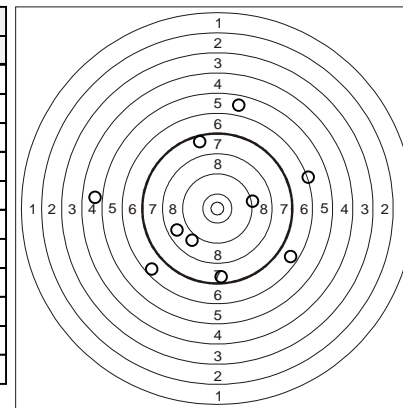

Heat 3			
	H	P	D
Tot	5/2/7	6,8	11,19
1	O	9,8	-
2	O	7,6	2,00
3	O	9,2	1,82
4	-	0,0	1,78
5	-	4,4	1,83
6	O	7,6	1,85
7	O	8,7	1,91

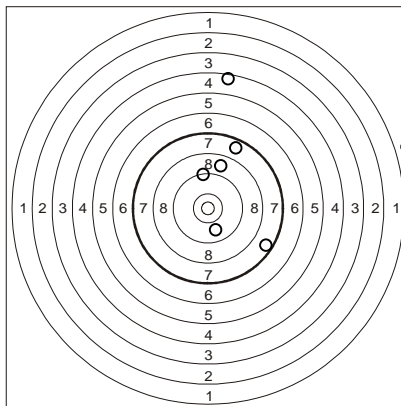

Heat 4			
	H	P	D
Tot	5/2/7	8,1	12,19
1	-	4,8	-
2	O	8,2	1,78
3	O	9,6	2,05
4	O	10,3	1,85
5	O	9,1	1,68
6	-	6,7	2,94
7	O	7,8	1,89

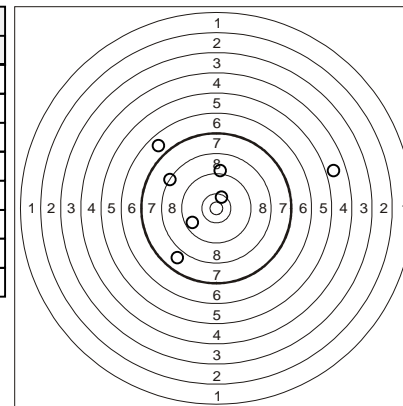

# INDIVIDUAL SHOOTING RESULTS

OLYMPIC HOPES U19&U17, SPALA-POLAND 2023 - MEN U19 HEAT1

0

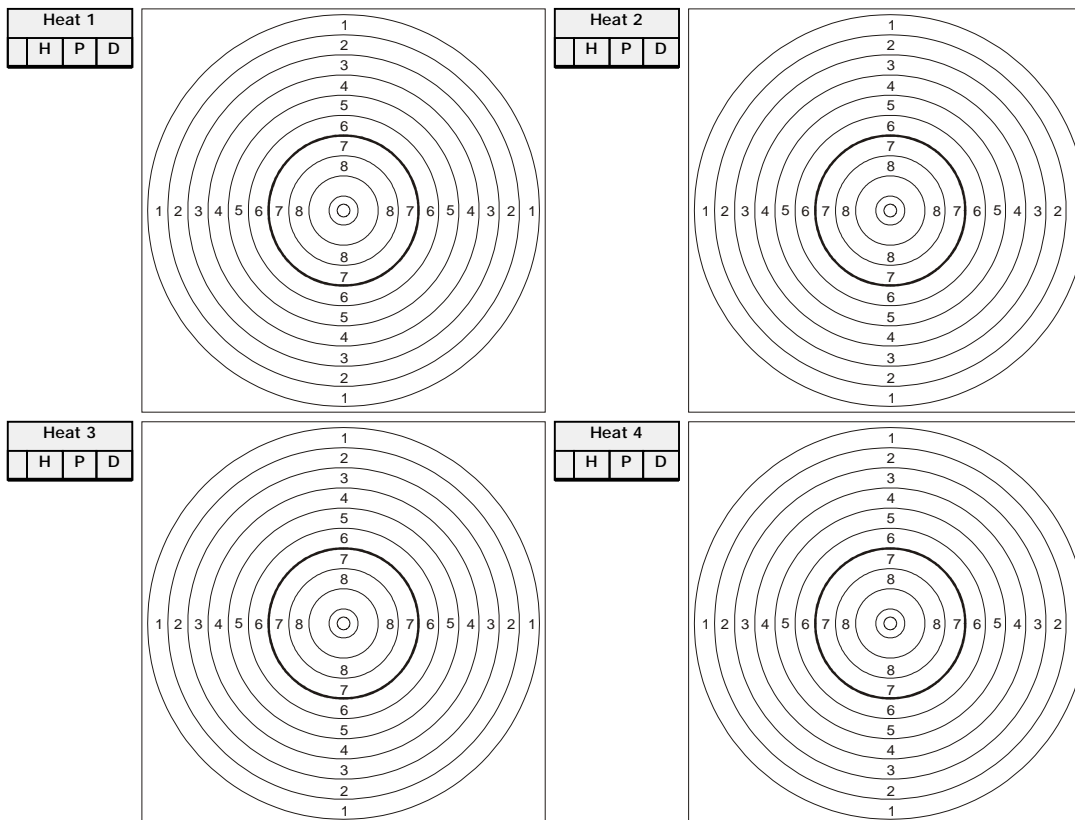

# INDIVIDUAL SHOOTING RESULTS

OLYMPIC HOPES U19&U17, SPALA-POLAND 2023 - MEN U19 HEAT1

0

