

INDIVIDUAL SHOOTING RESULTS

EUROPEAN GAMES KRAKOW 2023 - MIX RELAY

KRENKOVA VLACH (CZE)

Heat 1			
	H	P	D
Tot	5/4/9	7,4	17,22
1	O	7,6	-
2	O	9,1	2,06
3	-	4,4	2,19
4	O	7,6	2,13
5	-	5,4	2,21
6	-	7,2	2,13
7	-	5,5	2,12
8	O	10,0	2,15
9	O	9,8	2,23

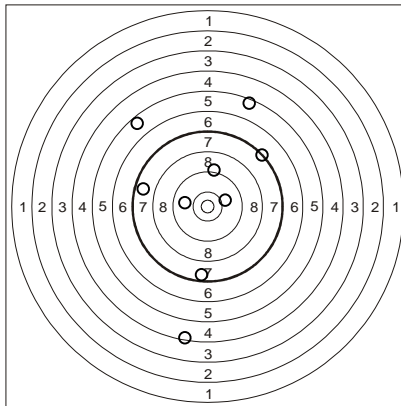

Heat 2			
	H	P	D
Tot	5/2/7	8,3	13,04
1	O	10,1	-
2	O	10,3	2,32
3	-	6,0	2,10
4	O	8,1	2,16
5	O	7,8	2,08
6	-	7,1	2,04
7	O	8,5	2,34

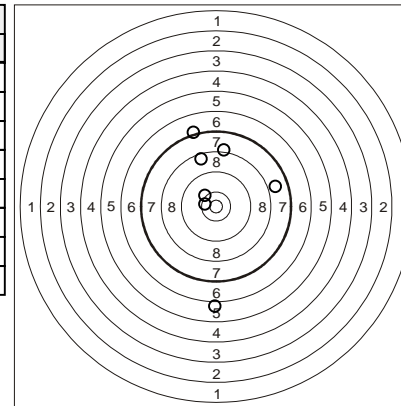

Heat 3			
	H	P	D
Tot	5/3/8	8,0	12,43
1	O	10,0	-
2	O	7,9	1,79
3	O	7,9	1,63
4	-	6,9	1,65
5	-	5,6	1,62
6	O	8,9	1,90
7	-	6,8	1,95
8	O	10,3	1,89

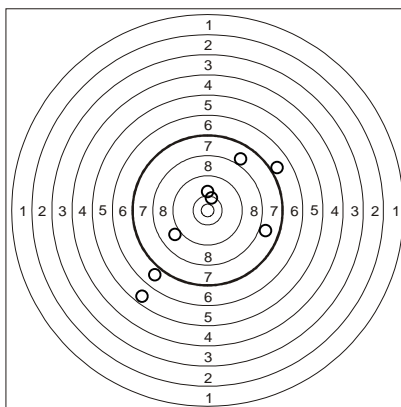

Heat 4			
	H	P	D
Tot	5/2/7	7,9	10,93
1	-	6,1	-
2	O	8,0	1,92
3	-	7,0	1,93
4	O	7,6	1,71
5	O	8,6	1,72
6	O	8,9	1,82
7	O	9,4	1,83

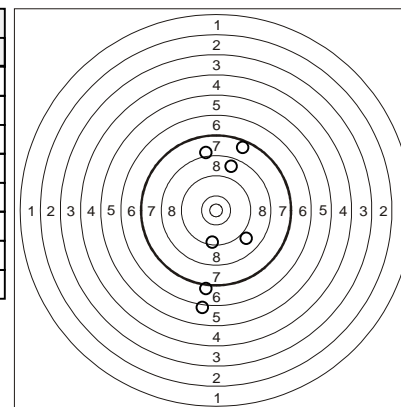

INDIVIDUAL SHOOTING RESULTS

EUROPEAN GAMES KRAKOW 2023 - MIX RELAY

RETI KOLESZAR (HUN)

Heat 1			
	H	P	D
Tot	5/13/18	6,3	34,91
1	-	6,7	-
2	O	7,6	2,15
3	-	6,2	2,21
4	-	4,6	2,04
5	-	4,4	2,13
6	-	2,8	2,16
7	-	7,0	2,03
8	-	6,1	2,10
9	-	2,6	2,04
10	O	8,4	1,87
11	-	5,5	1,96
12	-	4,7	1,95
13	-	6,8	2,28
14	-	6,3	1,92
15	-	6,7	2,01
16	O	7,5	2,07
17	O	9,9	2,09
18	O	9,1	1,90

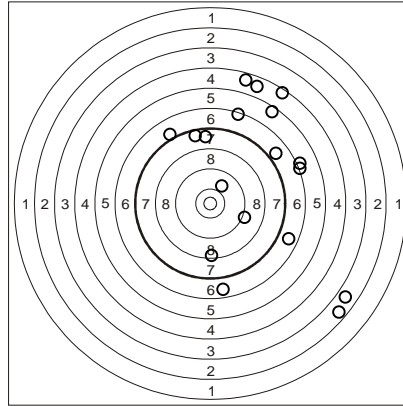

Heat 2			
	H	P	D
Tot	5/5/10	7,2	18,15
1	O	10,2	-
2	O	8,1	2,66
3	-	6,2	1,86
4	-	6,1	2,07
5	O	9,2	1,91
6	-	5,1	1,92
7	-	5,2	1,88
8	-	4,4	1,93
9	O	8,5	1,99
10	O	9,2	1,93

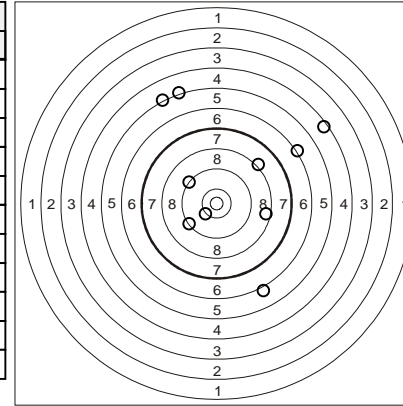

Heat 3			
	H	P	D
Tot	5/4/9	7,0	13,78
1	-	6,1	-
2	O	8,1	2,30
3	O	9,3	1,55
4	-	3,6	1,53
5	-	7,0	1,66
6	O	7,6	1,64
7	O	7,6	1,69
8	-	5,9	1,64
9	O	8,0	1,77

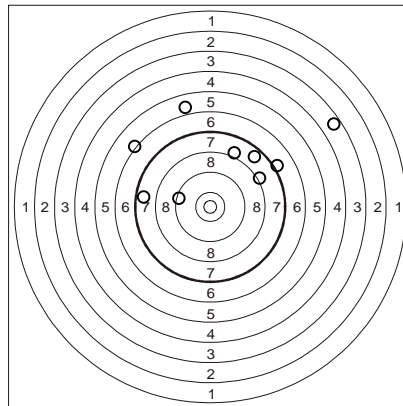

Heat 4			
	H	P	D
Tot	5/2/7	8,2	9,65
1	-	7,2	-
2	O	9,2	1,72
3	-	5,1	1,62
4	O	8,2	1,51
5	O	8,9	1,59
6	O	9,1	1,56
7	O	9,4	1,65

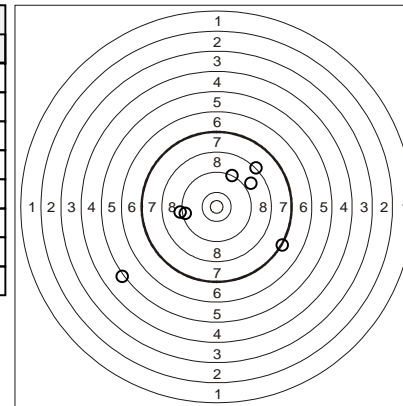

INDIVIDUAL SHOOTING RESULTS

EUROPEAN GAMES KRAKOW 2023 - MIX RELAY

JAWAID STEINBOCK (SWE)

Heat 1			
	H	P	D
Tot	5/2/7	7,5	11,92
1	O	7,4	-
2	O	9,4	2,29
3	O	9,3	2,05
4	-	2,6	1,76
5	-	6,5	2,04
6	O	8,1	1,94
7	O	8,9	1,84

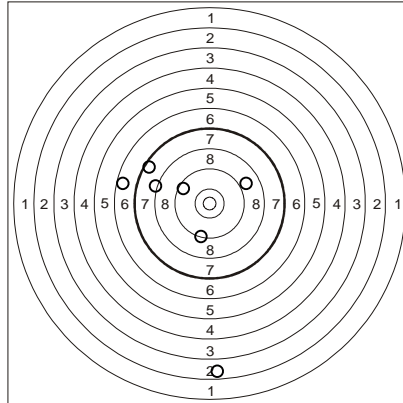

Heat 2			
	H	P	D
Tot	5/5/10	7,3	17,70
1	-	5,6	-
2	-	6,3	2,33
3	O	7,5	2,03
4	O	9,8	1,93
5	O	7,9	1,83
6	O	9,6	1,85
7	-	6,1	1,88
8	-	6,3	1,80
9	-	6,3	2,04
10	O	8,0	2,01

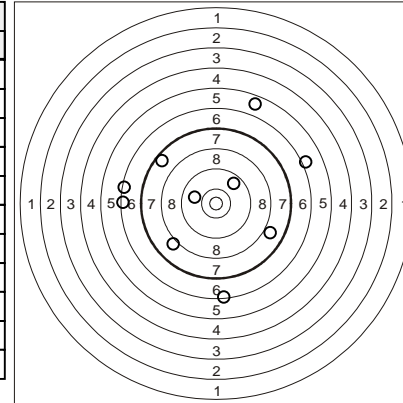

Heat 3			
	H	P	D
Tot	5/7/12	7,0	21,42
1	-	4,7	-
2	O	9,0	1,75
3	-	6,0	1,82
4	-	7,2	1,90
5	-	5,0	1,83
6	O	9,0	2,00
7	-	5,5	1,83
8	-	6,7	2,08
9	O	8,1	1,92
10	O	7,5	2,04
11	-	7,0	2,02
12	O	8,5	2,23

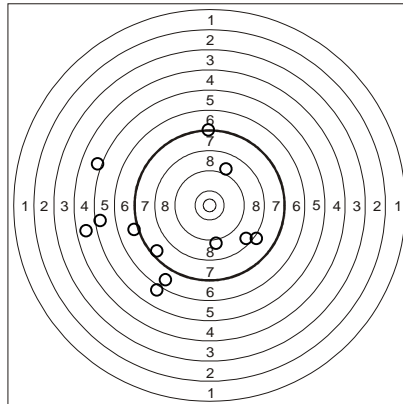

Heat 4			
	H	P	D
Tot	5/4/9	6,8	17,27
1	-	4,9	-
2	O	9,8	2,38
3	-	5,5	2,15
4	O	8,3	1,96
5	O	7,8	2,55
6	-	3,7	2,12
7	-	5,7	2,04
8	O	8,0	2,06
9	O	7,3	2,01

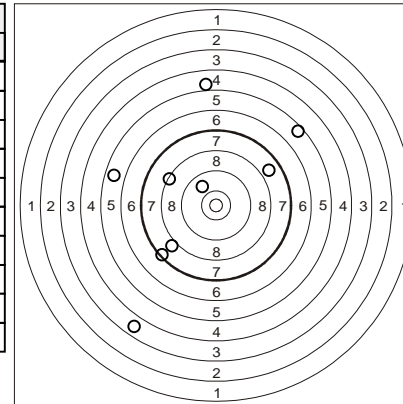

INDIVIDUAL SHOOTING RESULTS

EUROPEAN GAMES KRAKOW 2023 - MIX RELAY

EGLOFF MUELLER (SUI)

Heat 1			
	H	P	D
Tot	4/16/20	5,6	49,98
1	-	1,4	-
2	-	4,8	2,32
3	-	6,8	2,25
4	-	6,1	2,30
5	O	8,2	2,20
6	O	8,6	2,14
7	-	0,0	2,32
8	-	3,2	2,32
9	-	6,3	2,49
10	O	7,3	2,36
11	-	6,7	2,13
12	-	4,6	2,43
13	-	6,4	2,29
14	-	4,4	2,24
15	-	5,0	2,50
16	O	9,7	2,44
17	-	5,5	2,53
18	-	4,3	2,52
19	-	5,9	2,24
20	-	5,8	2,41

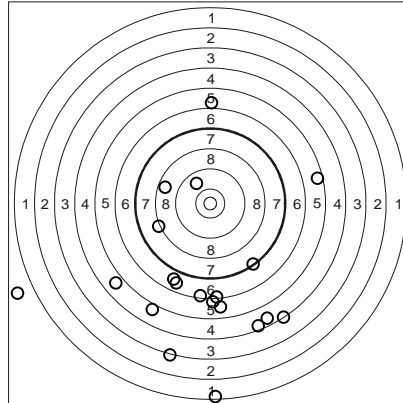

Heat 2			
	H	P	D
Tot	5/10/15	6,9	35,11
1	O	8,9	-
2	-	6,1	2,12
3	-	5,8	2,39
4	-	6,9	2,21
5	-	5,1	2,39
6	-	5,0	3,25
7	O	8,6	2,56
8	-	5,2	2,68
9	-	7,2	2,44
10	O	7,6	2,60
11	O	8,7	2,77
12	-	7,1	2,30
13	-	7,2	2,40
14	-	5,9	2,56
15	O	8,4	2,44

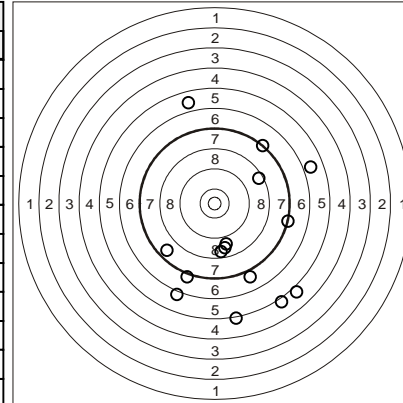

Heat 3			
	H	P	D
Tot	5/2/7	8,2	15,36
1	O	7,6	-
2	O	9,3	4,23
3	-	6,6	2,13
4	-	7,0	2,22
5	O	8,6	2,10
6	O	8,5	2,35
7	O	10,1	2,33

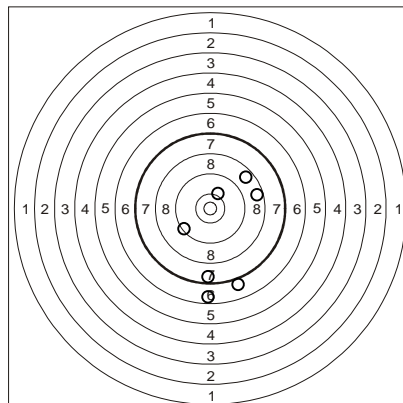

Heat 4			
	H	P	D
Tot	5/1/6	7,8	10,05
1	O	8,8	-
2	O	7,8	2,16
3	-	5,3	2,02
4	O	7,5	1,85
5	O	9,2	2,07
6	O	8,0	1,95

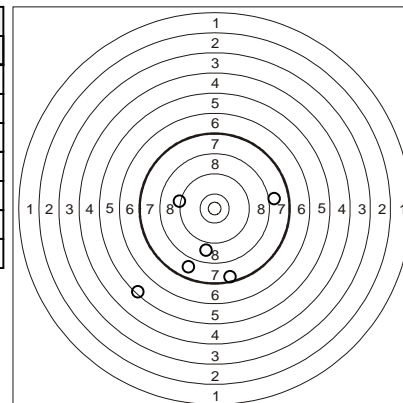

INDIVIDUAL SHOOTING RESULTS

EUROPEAN GAMES KRAKOW 2023 - MIX RELAY

OZYUKSEL UNAL (TUR)

Heat 1			
	H	P	D
Tot	5/6/11	6,9	22,62
1	-	4,5	-
2	-	7,2	2,30
3	O	8,9	2,16
4	O	8,7	2,21
5	-	2,2	2,14
6	-	6,6	2,42
7	O	9,8	2,18
8	O	9,1	2,13
9	-	5,6	2,36
10	-	6,1	2,27
11	O	7,3	2,45

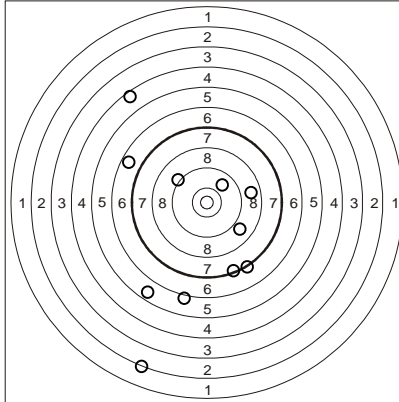

Heat 2			
	H	P	D
Tot	5/4/9	6,6	16,71
1	-	0,0	-
2	O	8,0	2,25
3	-	6,2	2,15
4	O	8,1	1,98
5	-	7,2	1,92
6	-	5,0	2,13
7	O	9,0	1,94
8	O	8,5	2,12
9	O	7,6	2,22

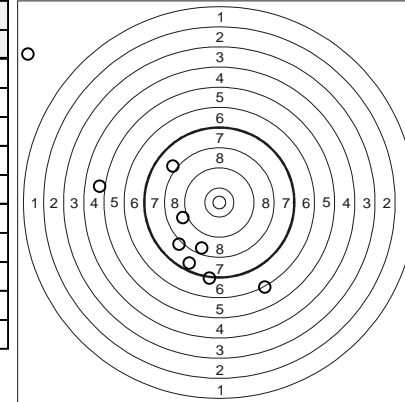

Heat 3			
	H	P	D
Tot	5/3/8	8,6	15,88
1	O	10,4	-
2	-	7,2	2,21
3	-	7,2	2,06
4	O	9,3	2,25
5	O	8,1	2,89
6	-	7,2	2,13
7	O	10,1	2,10
8	O	9,3	2,24

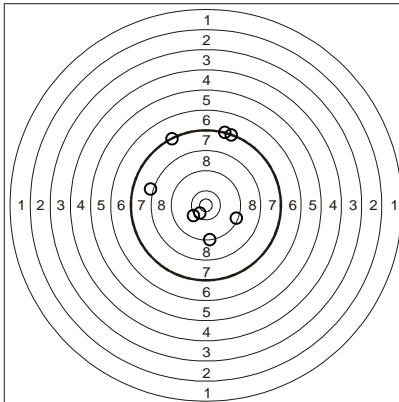

Heat 4			
	H	P	D
Tot	5/8/13	7,0	25,51
1	-	5,4	-
2	-	6,8	2,19
3	-	6,6	2,08
4	O	9,3	2,02
5	O	7,4	2,13
6	-	4,9	2,13
7	-	6,2	2,05
8	O	8,7	2,10
9	-	7,1	2,14
10	-	3,6	2,20
11	O	9,7	2,02
12	-	7,1	2,10
13	O	8,0	2,35

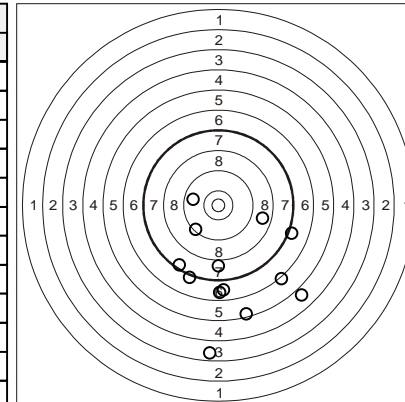

INDIVIDUAL SHOOTING RESULTS

EUROPEAN GAMES KRAKOW 2023 - MIX RELAY

VARLEY CURRY (GBR)

Heat 1			
	H	P	D
Tot	5/3/8	7,6	14,09
1	O	8,2	-
2	-	6,5	2,34
3	O	8,5	1,82
4	-	6,8	2,04
5	O	7,6	2,21
6	-	5,9	1,82
7	O	9,1	1,92
8	O	8,5	1,94

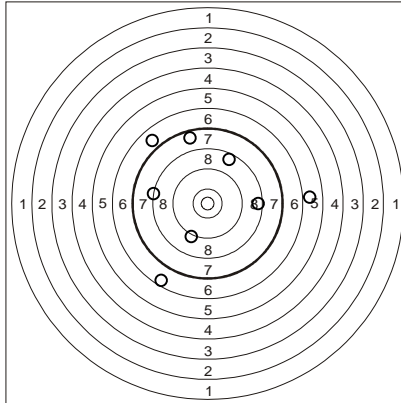

Heat 2			
	H	P	D
Tot	5/1/6	8,0	10,24
1	O	8,6	-
2	O	8,2	2,15
3	O	7,6	1,92
4	O	9,0	1,92
5	-	6,1	2,04
6	O	8,3	2,21

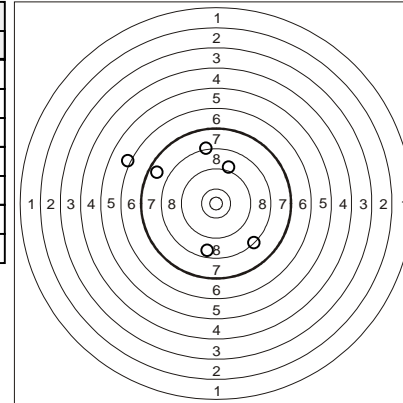

Heat 3			
	H	P	D
Tot	5/2/7	8,3	14,49
1	-	7,0	-
2	O	9,2	2,22
3	-	4,9	2,21
4	O	10,2	4,08
5	O	8,0	2,01
6	O	9,7	1,94
7	O	9,3	2,03

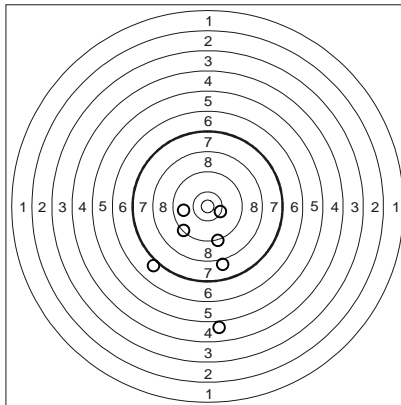

Heat 4			
	H	P	D
Tot	5/4/9	7,5	15,75
1	O	8,0	-
2	O	9,7	2,09
3	O	7,5	1,85
4	-	5,9	1,80
5	-	7,1	1,94
6	-	5,4	1,93
7	-	6,1	2,01
8	O	9,4	2,21
9	O	8,1	1,92

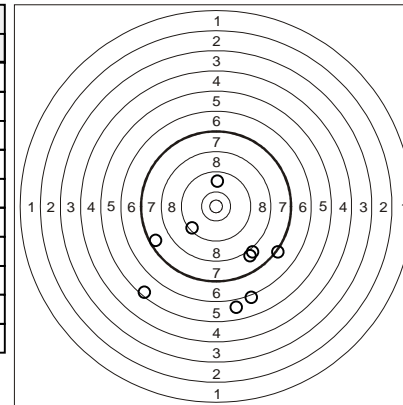

INDIVIDUAL SHOOTING RESULTS

EUROPEAN GAMES KRAKOW 2023 - MIX RELAY

MEDINA HEREDIA (ESP)

Heat 1			
	H	P	D
Tot	5/1/6	8,2	8,77
1	O	9,3	-
2	O	8,5	1,73
3	O	7,3	1,61
4	O	8,4	1,55
5	-	6,9	1,98
6	O	8,9	1,90

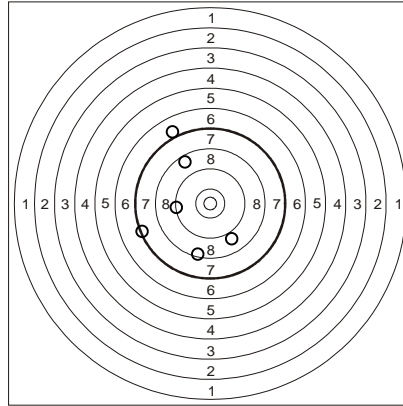

Heat 2			
	H	P	D
Tot	5/1/6	7,7	9,14
1	O	9,9	-
2	O	7,7	1,77
3	O	9,6	1,67
4	-	1,9	1,87
5	O	8,2	2,07
6	O	8,6	1,76

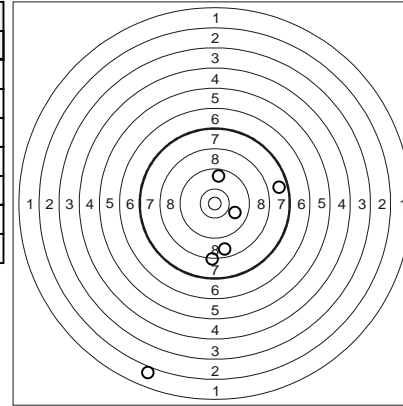

Heat 3			
	H	P	D
Tot	5/3/8	7,1	18,81
1	-	2,2	-
2	O	8,0	2,60
3	O	7,5	2,44
4	O	8,7	2,53
5	O	8,5	2,60
6	-	6,5	2,71
7	-	5,8	2,85
8	O	9,5	3,08

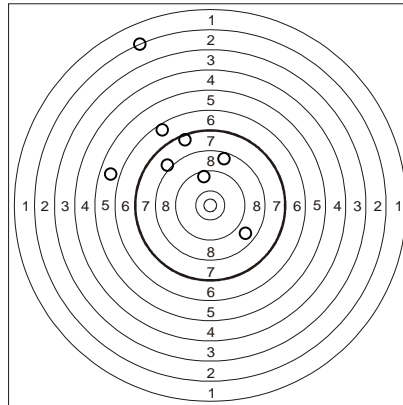

Heat 4			
	H	P	D
Tot	5/3/8	7,9	17,88
1	-	5,8	-
2	-	6,6	2,74
3	O	7,6	2,42
4	O	9,3	2,46
5	O	8,4	2,43
6	O	9,9	2,43
7	-	6,6	2,45
8	O	8,9	2,95

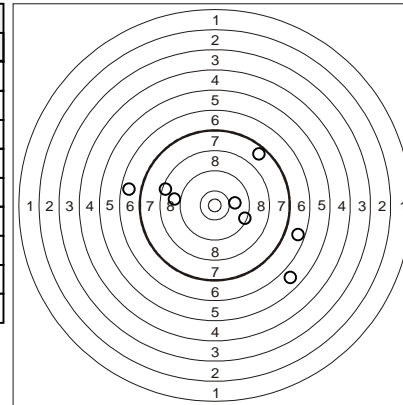

INDIVIDUAL SHOOTING RESULTS

EUROPEAN GAMES KRAKOW 2023 - MIX RELAY

JOGISU KALLASTE (EST)

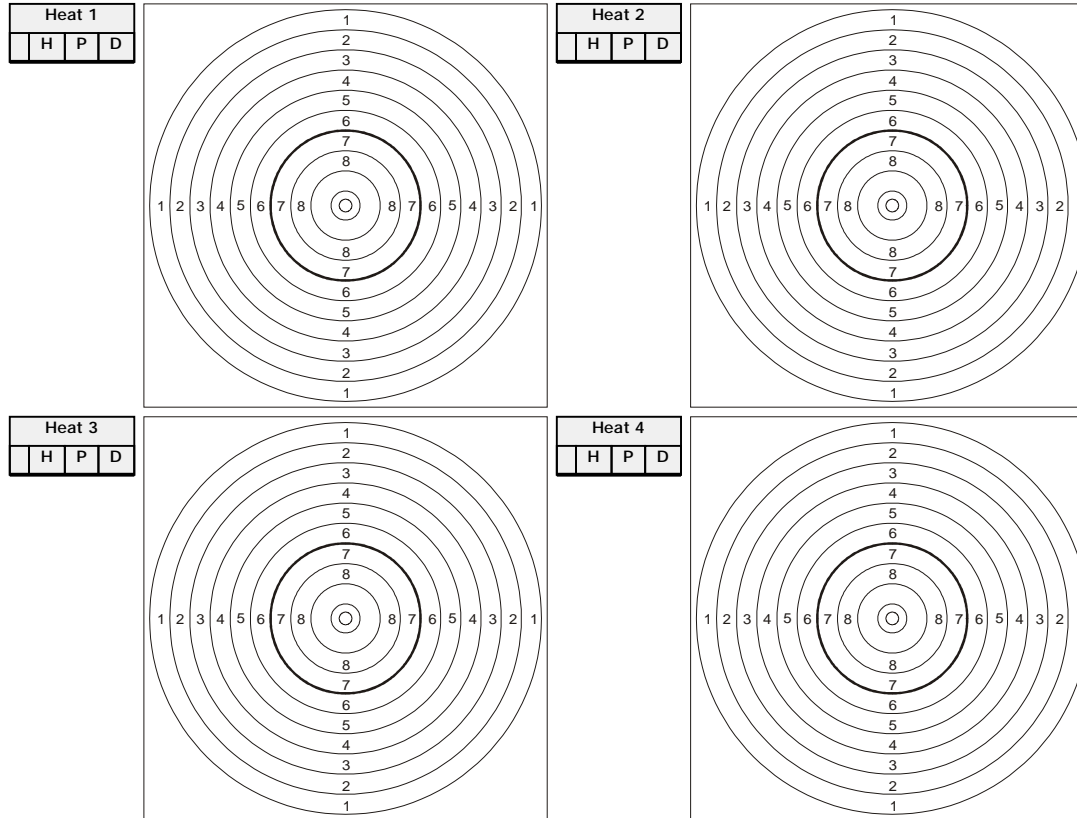

INDIVIDUAL SHOOTING RESULTS

EUROPEAN GAMES KRAKOW 2023 - MIX RELAY

KHOKHLOVA KOVALCHUK (UKR)

Heat 1			
	H	P	D
Tot	5/2/7	7,2	15,02
1	O	7,7	-
2	-	5,0	2,99
3	O	9,3	2,31
4	-	5,9	2,46
5	O	7,7	2,42
6	O	7,6	2,41
7	O	7,5	2,43

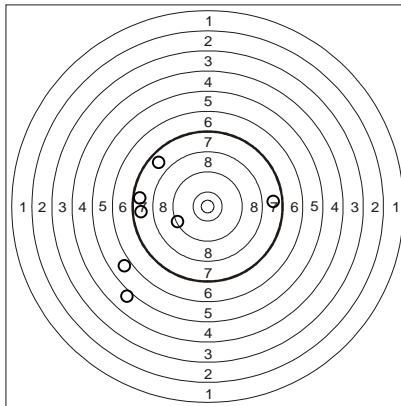

Heat 2			
	H	P	D
Tot	5/3/8	7,4	16,40
1	O	8,8	-
2	-	4,2	2,29
3	-	6,7	2,40
4	O	10,2	2,12
5	-	6,5	2,21
6	O	7,3	2,52
7	O	7,6	2,33
8	O	7,8	2,53

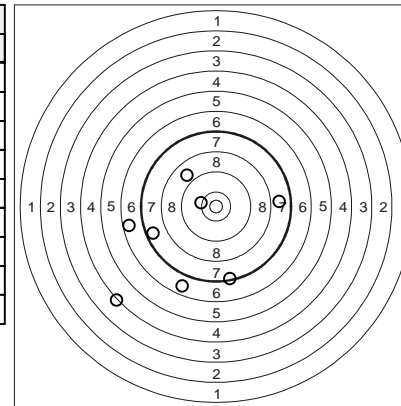

Heat 3			
	H	P	D
Tot	5/1/6	8,3	10,36
1	O	8,2	-
2	-	5,1	1,92
3	O	9,5	1,93
4	O	8,8	1,80
5	O	9,9	1,90
6	O	8,5	2,81

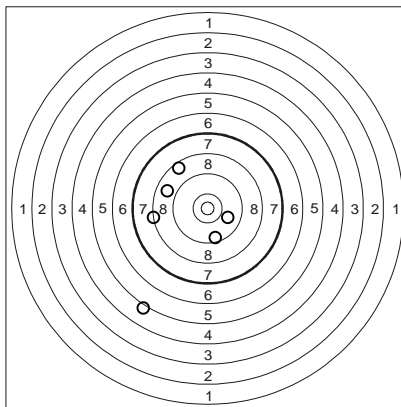

Heat 4			
	H	P	D
Tot	5/0/5	8,9	7,24
1	O	8,6	-
2	O	8,3	1,99
3	O	10,2	1,72
4	O	8,0	1,71
5	O	9,2	1,82

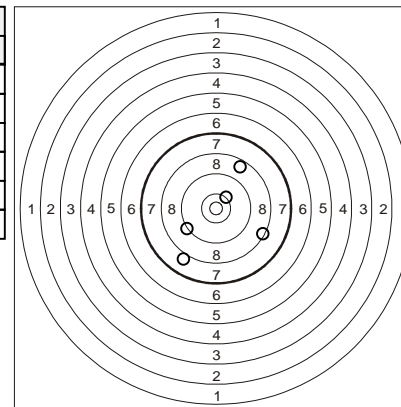

INDIVIDUAL SHOOTING RESULTS

EUROPEAN GAMES KRAKOW 2023 - MIX RELAY

TCHITADZE KHIJAKADZE (GEO)

Heat 1			
	H	P	D
Tot	5/1/6	8,0	10,13
1	O	8,6	-
2	O	8,6	2,30
3	-	4,6	1,86
4	O	9,9	2,04
5	O	8,4	2,02
6	O	8,1	1,91

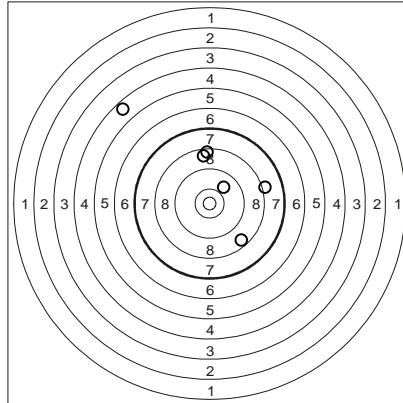

Heat 2			
	H	P	D
Tot	5/3/8	7,2	15,67
1	O	8,5	-
2	-	6,6	2,30
3	O	7,9	2,09
4	-	7,1	2,05
5	O	7,9	2,24
6	O	7,3	2,22
7	-	4,5	2,12
8	O	7,5	2,65

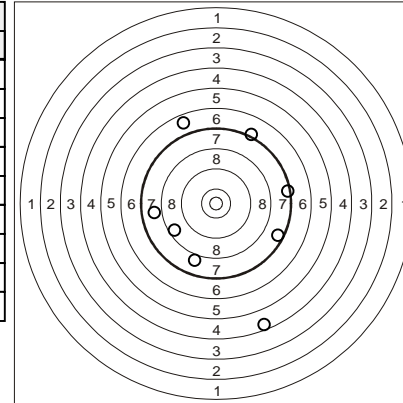

Heat 3			
	H	P	D
Tot	5/1/6	8,0	8,79
1	O	7,8	-
2	O	8,9	1,82
3	O	9,3	1,90
4	-	4,0	1,74
5	O	9,0	1,64
6	O	8,8	1,69

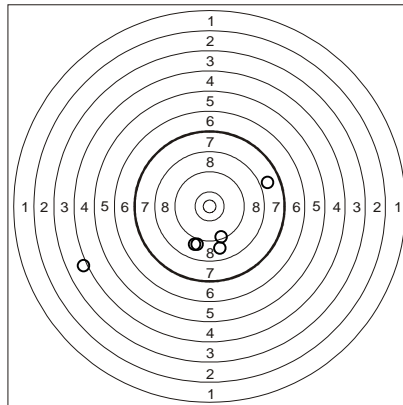

Heat 4			
	H	P	D
Tot	5/6/11	7,5	17,37
1	O	7,7	-
2	-	6,9	2,04
3	-	6,9	1,61
4	-	5,3	1,60
5	-	6,7	1,81
6	O	9,8	1,59
7	-	6,4	1,73
8	-	5,4	1,72
9	O	8,7	1,71
10	O	9,2	1,75
11	O	9,4	1,81

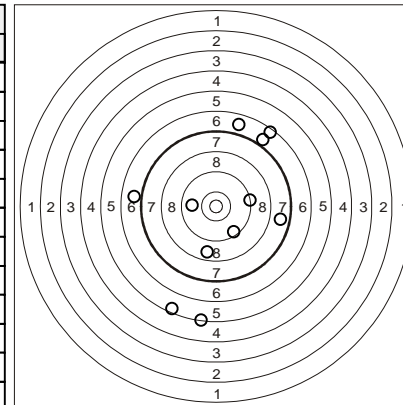

INDIVIDUAL SHOOTING RESULTS

EUROPEAN GAMES KRAKOW 2023 - MIX RELAY

DOMINIAK LAWRYN. (POL)

Heat 1			
	H	P	D
Tot	5/4/9	7,9	15,21
1	-	7,0	-
2	O	9,0	1,87
3	O	8,6	1,83
4	O	8,0	1,79
5	-	5,1	1,77
6	O	10,4	1,89
7	-	6,7	1,89
8	-	6,2	2,06
9	O	10,2	2,11

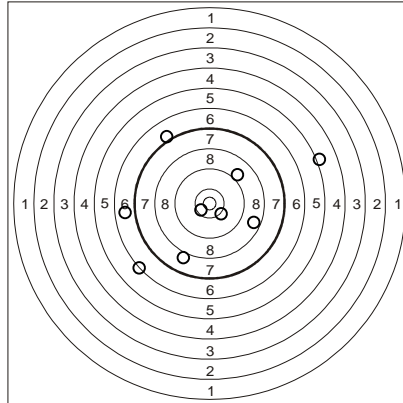

Heat 2			
	H	P	D
Tot	5/1/6	8,0	8,47
1	-	6,5	-
2	O	8,0	1,79
3	O	7,5	1,69
4	O	9,7	1,64
5	O	7,5	1,65
6	O	8,9	1,70

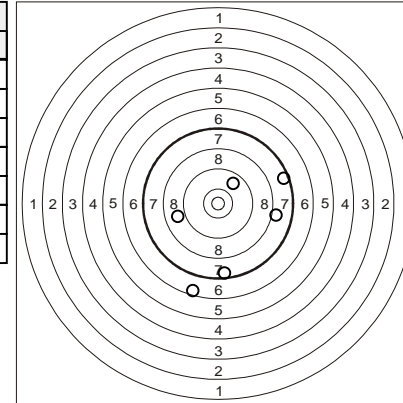

Heat 3			
	H	P	D
Tot	5/1/6	8,2	10,31
1	O	8,6	-
2	O	8,1	2,40
3	-	5,7	1,97
4	O	9,9	1,93
5	O	8,5	2,17
6	O	8,4	1,84

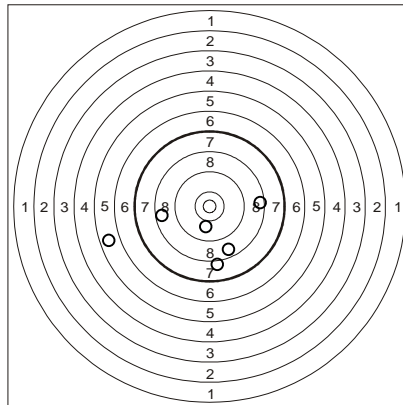

Heat 4			
	H	P	D
Tot	5/1/6	8,3	10,90
1	O	10,2	-
2	O	9,7	2,91
3	O	10,3	1,96
4	-	3,4	1,86
5	O	8,0	1,98
6	O	8,2	2,19

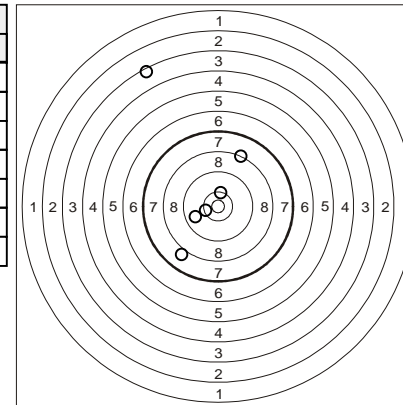

INDIVIDUAL SHOOTING RESULTS

EUROPEAN GAMES KRAKOW 2023 - MIX RELAY

LEH ZILLEKENS (GER)

Heat 1			
	H	P	D
Tot	5/1/6	8,2	12,34
1	O	8,5	-
2	-	7,2	2,45
3	O	7,7	2,61
4	O	7,3	2,57
5	O	9,4	2,46
6	O	9,3	2,25

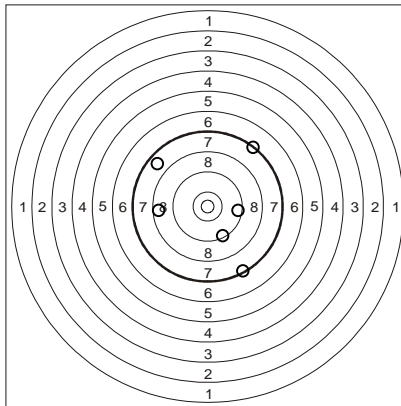

Heat 2			
	H	P	D
Tot	5/0/5	9,3	9,78
1	O	7,9	-
2	O	10,1	2,42
3	O	9,8	2,41
4	O	10,2	2,63
5	O	8,7	2,32

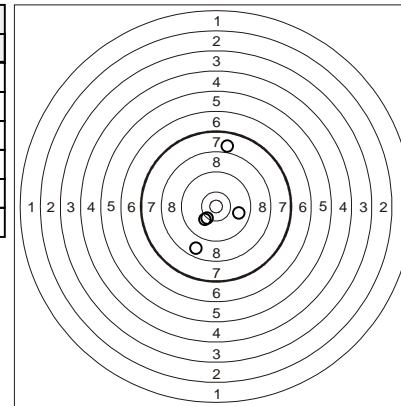

Heat 3			
	H	P	D
Tot	5/0/5	8,5	8,99
1	O	8,1	-
2	O	7,9	2,49
3	O	8,9	2,19
4	O	8,6	2,15
5	O	8,8	2,16

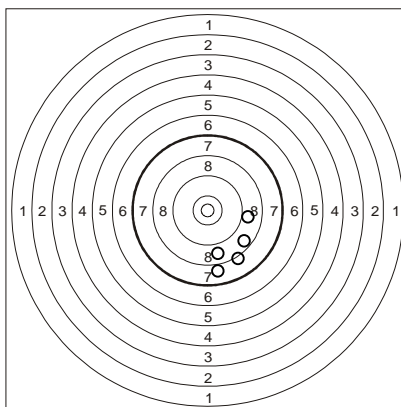

Heat 4			
	H	P	D
Tot	5/1/6	8,4	10,62
1	O	7,7	-
2	O	10,0	2,09
3	O	7,9	2,05
4	-	7,0	2,22
5	O	8,9	1,91
6	O	8,8	2,35

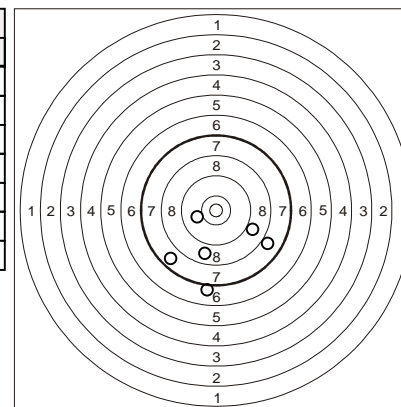

INDIVIDUAL SHOOTING RESULTS

EUROPEAN GAMES KRAKOW 2023 - MIX RELAY

NASKARI SECHIDIS (GRE)

Heat 1			
	H	P	D
Tot	5/11/16	7,0	28,70
1	-	6,3	-
2	O	8,5	1,81
3	-	5,0	1,74
4	-	6,9	1,80
5	O	7,5	2,00
6	-	6,1	1,74
7	-	5,8	2,35
8	-	6,9	1,82
9	-	6,5	1,78
10	O	8,2	2,07
11	O	8,8	1,68
12	-	6,3	1,56
13	-	7,1	1,79
14	-	6,2	2,32
15	-	6,8	1,83
16	O	9,8	2,41

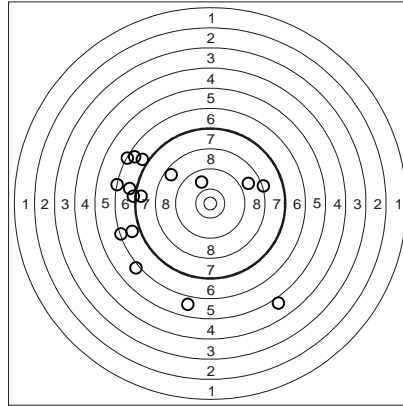

Heat 2			
	H	P	D
Tot	5/4/9	6,6	14,09
1	O	8,5	-
2	O	9,1	1,45
3	-	3,9	1,67
4	O	9,8	1,93
5	-	0,0	1,64
6	-	5,0	1,68
7	-	5,8	1,85
8	O	9,8	2,01
9	O	7,3	1,86

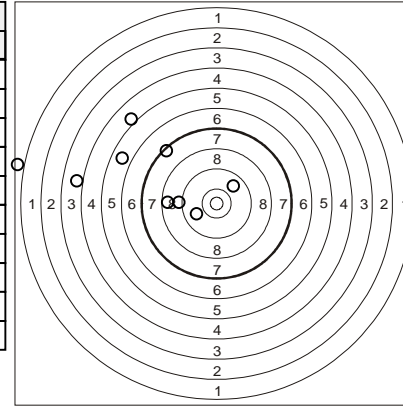

Heat 3			
	H	P	D
Tot	5/3/8	8,1	13,27
1	-	5,6	-
2	O	9,4	1,89
3	-	7,0	1,76
4	O	7,8	1,92
5	O	8,1	1,91
6	O	10,4	1,83
7	-	7,1	1,79
8	O	9,0	2,17

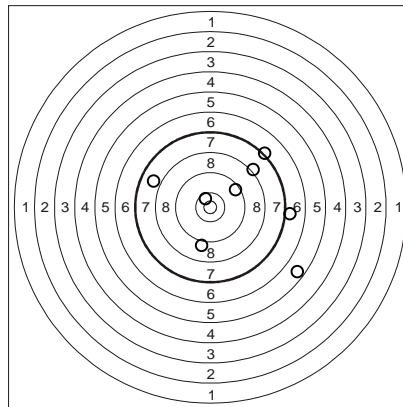

Heat 4			
	H	P	D
Tot	5/4/9	7,5	14,74
1	O	9,6	-
2	-	5,7	1,66
3	O	7,6	1,86
4	-	4,8	1,64
5	-	4,7	1,82
6	O	10,1	1,69
7	-	6,0	1,81
8	O	9,8	1,82
9	O	8,9	2,44

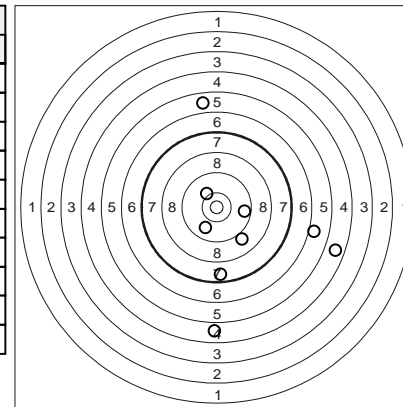

INDIVIDUAL SHOOTING RESULTS

EUROPEAN GAMES KRAKOW 2023 - MIX RELAY

MITEVA KOLEV (BUL)

Heat 1			
	H	P	D
Tot	5/5/10	7,1	17,52
1	O	9,7	-
2	-	6,5	1,99
3	O	8,4	1,68
4	-	3,6	1,94
5	-	6,8	1,79
6	O	8,1	1,85
7	O	7,6	2,03
8	-	7,1	1,90
9	-	6,1	2,25
10	O	7,5	2,09

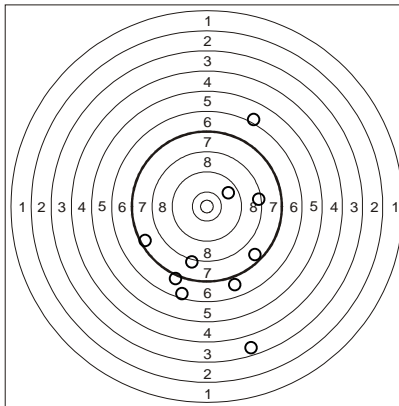

Heat 2			
	H	P	D
Tot	5/2/7	8,2	11,16
1	O	10,6	-
2	O	7,9	1,81
3	-	6,9	1,83
4	O	9,2	1,82
5	O	7,3	2,02
6	-	6,8	1,59
7	O	8,7	2,09

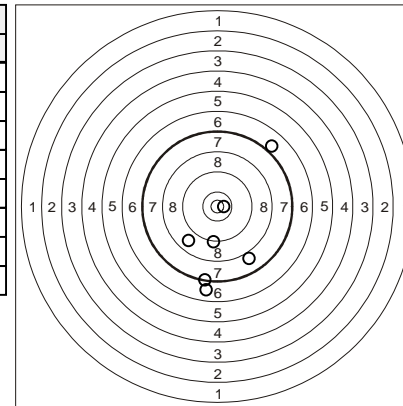

Heat 3			
	H	P	D
Tot	5/1/6	8,4	10,78
1	O	8,0	-
2	O	8,9	2,38
3	O	7,9	2,14
4	O	8,9	1,97
5	-	6,4	1,96
6	O	10,2	2,33

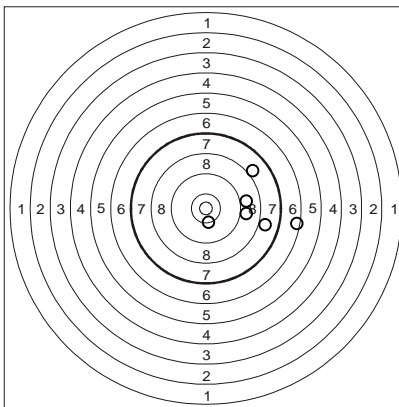

Heat 4			
	H	P	D
Tot	5/5/10	7,3	20,36
1	-	6,8	-
2	O	9,8	2,39
3	-	7,1	2,13
4	O	8,6	2,16
5	O	7,6	2,31
6	-	4,6	2,33
7	O	9,1	2,17
8	-	6,6	2,23
9	-	4,8	2,31
10	O	7,5	2,33

