

INDIVIDUAL SHOOTING RESULTS

WORLD CUP SOFIA2023 - WOMEN'S QUALIFICATION "A"

Sunwoo KIM (KOR)

Heat 1			
	H	P	D
Tot	5/2/7	7,7	11,74
1	O	8,5	-
2	-	5,4	2,07
3	O	9,8	1,92
4	O	8,1	2,07
5	-	4,5	1,95
6	O	9,5	1,92
7	O	8,3	1,81

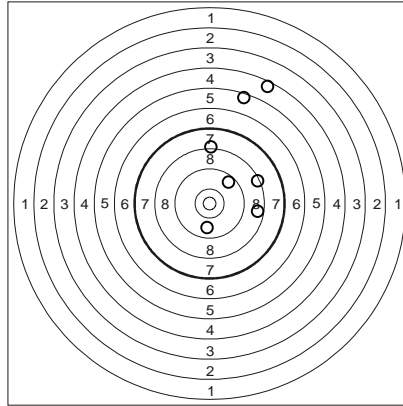

Heat 2			
	H	P	D
Tot	5/0/5	8,8	8,68
1	O	9,2	-
2	O	9,5	1,82
3	O	8,9	3,03
4	O	8,0	1,98
5	O	8,3	1,85

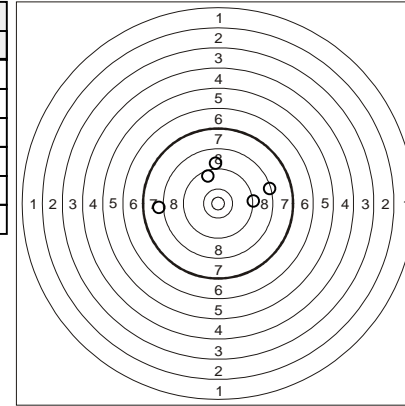

Heat 3			
	H	P	D
Tot	5/0/5	9,2	7,41
1	O	8,8	-
2	O	8,1	1,96
3	O	10,2	1,76
4	O	10,5	1,83
5	O	8,5	1,86

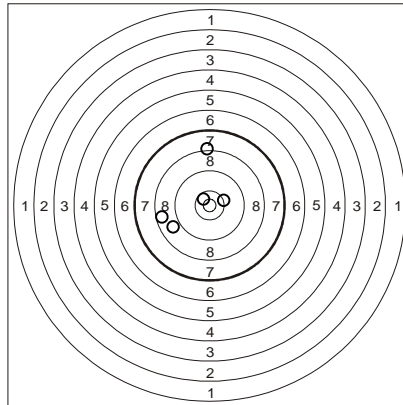

Heat 4			
	H	P	D
Tot	5/3/8	8,6	13,76
1	O	8,0	-
2	-	6,6	2,03
3	-	6,8	2,01
4	-	6,2	1,86
5	O	10,7	2,08
6	O	10,2	1,92
7	O	9,4	1,88
8	O	10,5	1,98

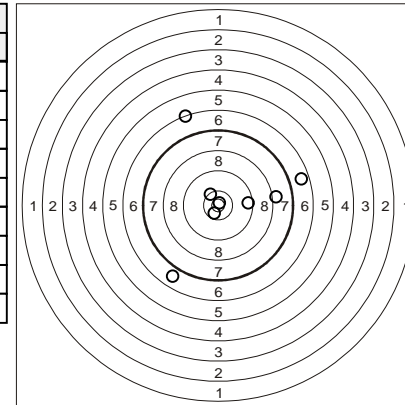

INDIVIDUAL SHOOTING RESULTS

WORLD CUP SOFIA2023 - WOMEN'S QUALIFICATION "A"

Elodie CLOUVEL (FRA)

Heat 1			
	H	P	D
Tot	5/0/5	8,7	9,00
1	O	9,6	-
2	O	7,7	2,24
3	O	7,3	2,29
4	O	8,4	2,26
5	O	10,5	2,21

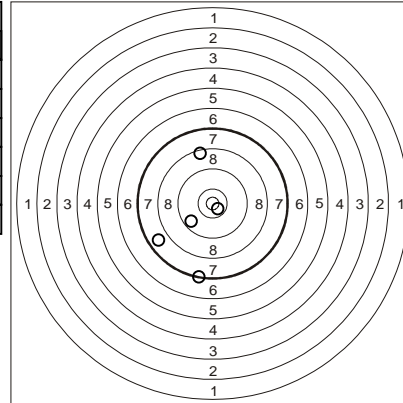

Heat 2			
	H	P	D
Tot	5/4/9	7,1	18,33
1	O	7,3	-
2	-	7,0	2,34
3	O	8,4	2,24
4	O	8,7	2,39
5	-	4,2	2,23
6	-	1,1	2,33
7	-	7,0	2,21
8	O	10,0	2,32
9	O	10,4	2,27

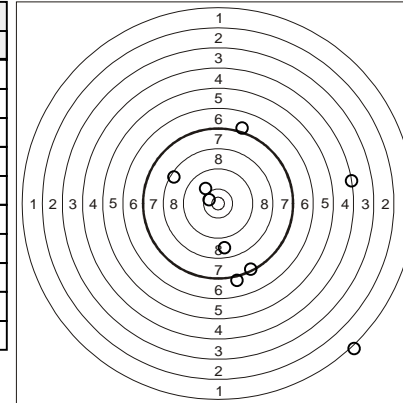

Heat 3			
	H	P	D
Tot	5/2/7	8,0	13,12
1	-	5,2	-
2	O	9,4	2,34
3	O	9,4	2,20
4	-	6,1	2,06
5	O	9,7	2,20
6	O	8,8	2,14
7	O	7,6	2,18

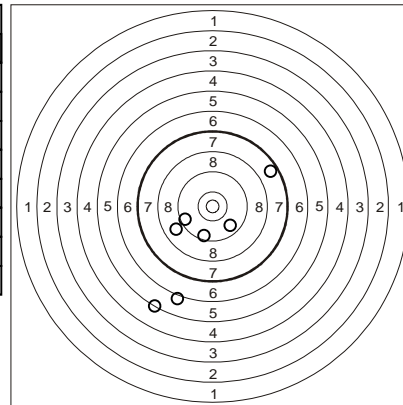

Heat 4			
	H	P	D
Tot	5/4/9	7,6	17,55
1	O	7,4	-
2	O	10,4	2,13
3	-	5,3	2,09
4	-	6,7	2,23
5	O	9,6	2,23
6	-	5,9	2,21
7	-	4,2	2,20
8	O	8,3	2,23
9	O	10,5	2,23

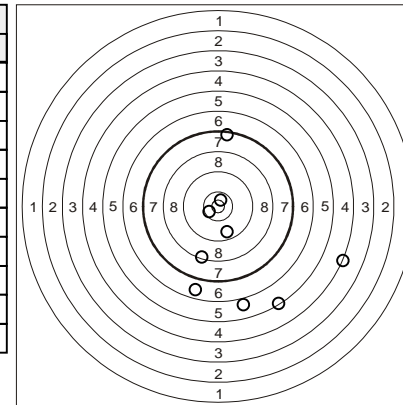

INDIVIDUAL SHOOTING RESULTS

WORLD CUP SOFIA2023 - WOMEN'S QUALIFICATION "A"

Janine KOHLMANN (GER)

Heat 1			
	H	P	D
Tot	5/5/10	7,4	18,91
1	-	7,0	-
2	O	9,3	2,29
3	O	9,1	2,16
4	O	10,1	2,20
5	-	3,3	1,81
6	-	6,8	2,15
7	O	8,7	2,00
8	-	5,7	2,04
9	-	6,4	2,04
10	O	8,0	2,22

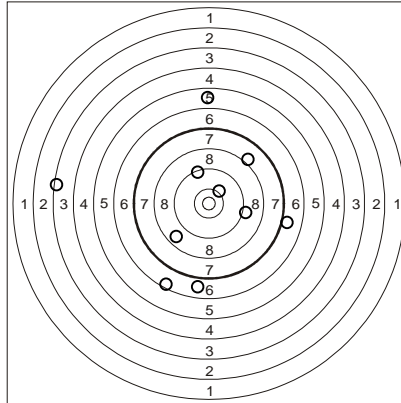

Heat 2			
	H	P	D
Tot	5/1/6	8,8	10,41
1	O	8,9	-
2	O	7,8	2,13
3	O	9,4	1,87
4	-	6,2	2,16
5	O	10,6	2,09
6	O	9,8	2,16

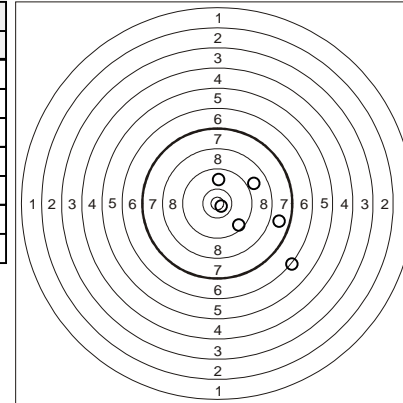

Heat 3			
	H	P	D
Tot	5/1/6	7,5	10,62
1	O	7,4	-
2	O	8,4	2,07
3	O	8,3	2,07
4	O	8,9	2,18
5	-	4,5	2,12
6	O	7,3	2,18

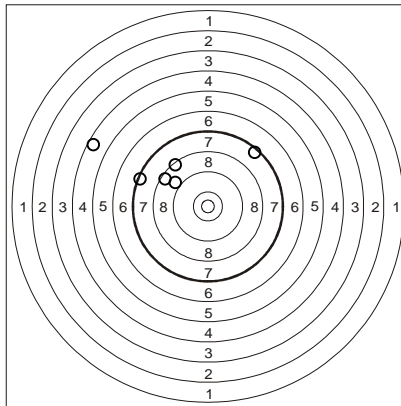

Heat 4			
	H	P	D
Tot	5/0/5	8,6	8,11
1	O	8,5	-
2	O	8,3	2,02
3	O	8,1	1,98
4	O	9,3	2,07
5	O	8,8	2,04

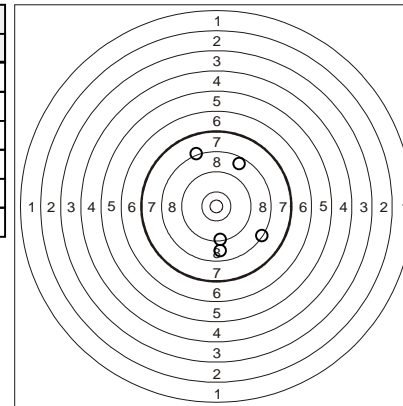

INDIVIDUAL SHOOTING RESULTS

WORLD CUP SOFIA2023 - WOMEN'S QUALIFICATION "A"

Xiuting ZHONG (CHN)

Heat 1			
	H	P	D
Tot	5/7/12	7,4	21,30
1	O	7,6	-
2	-	6,1	1,97
3	O	9,6	1,88
4	-	6,7	2,14
5	-	6,4	1,93
6	O	9,0	1,90
7	-	6,7	1,93
8	-	6,6	1,83
9	O	9,2	1,74
10	-	7,2	1,94
11	-	4,7	2,08
12	O	8,6	1,96

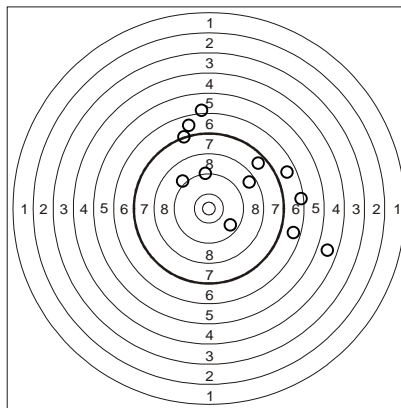

Heat 2			
	H	P	D
Tot	5/0/5	7,9	8,62
1	O	8,1	-
2	O	8,1	2,93
3	O	8,5	1,97
4	O	7,3	1,77
5	O	7,4	1,95

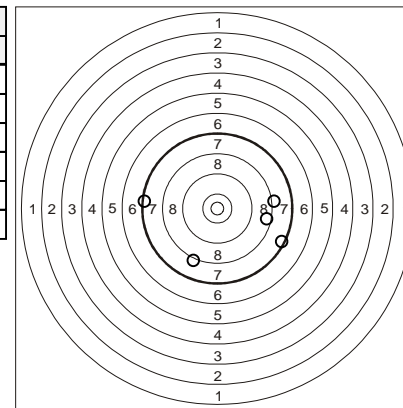

Heat 3			
	H	P	D
Tot	5/4/9	7,8	15,94
1	-	6,6	-
2	-	5,4	2,15
3	-	6,7	2,03
4	O	8,7	2,01
5	O	8,7	2,01
6	O	10,3	1,93
7	-	5,9	1,97
8	O	9,2	1,87
9	O	9,0	1,97

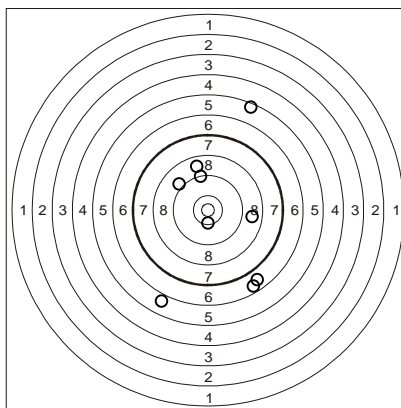

Heat 4			
	H	P	D
Tot	5/3/8	7,3	13,28
1	O	7,7	-
2	O	9,1	1,82
3	O	7,5	1,88
4	O	7,7	1,76
5	-	7,0	1,74
6	-	3,9	2,02
7	-	7,2	1,70
8	O	8,5	2,36

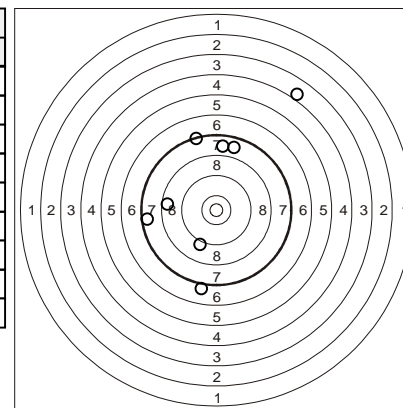

INDIVIDUAL SHOOTING RESULTS

WORLD CUP SOFIA2023 - WOMEN'S QUALIFICATION "A"

Andrea MEDINA GONZALEZ (ESP)

Heat 1			
	H	P	D
Tot	5/2/7	7,7	10,84
1	O	8,2	-
2	O	8,7	1,92
3	-	4,3	1,84
4	O	7,9	1,67
5	-	7,1	1,77
6	O	9,8	1,83
7	O	8,1	1,81

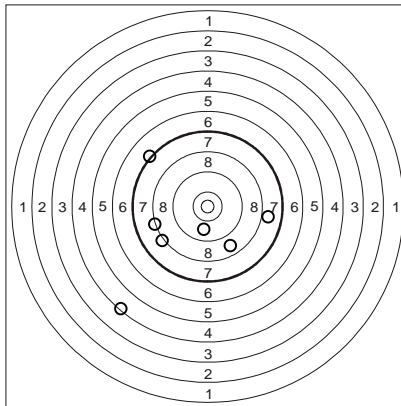

Heat 2			
	H	P	D
Tot	5/1/6	8,9	8,79
1	-	7,0	-
2	O	10,6	1,87
3	O	10,2	1,60
4	O	8,2	1,72
5	O	7,6	1,78
6	O	9,5	1,82

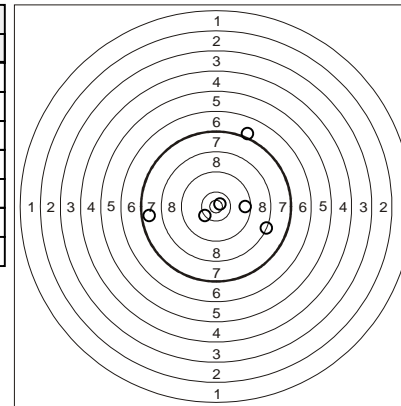

Heat 3			
	H	P	D
Tot	5/1/6	8,5	9,15
1	-	4,3	-
2	O	8,8	1,96
3	O	10,2	1,80
4	O	10,2	1,82
5	O	7,4	1,67
6	O	10,3	1,90

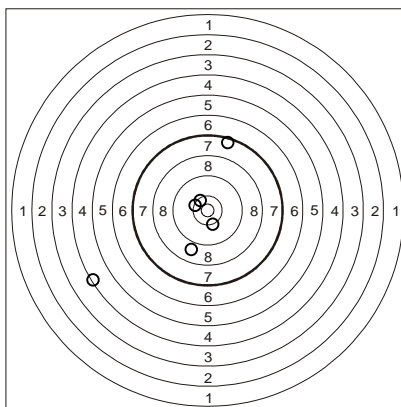

Heat 4			
	H	P	D
Tot	5/4/9	7,4	15,16
1	O	7,9	-
2	-	5,5	2,08
3	O	7,7	1,83
4	O	8,5	1,64
5	-	6,1	1,62
6	-	6,8	1,70
7	-	6,2	1,73
8	O	8,8	1,96
9	O	8,7	2,60

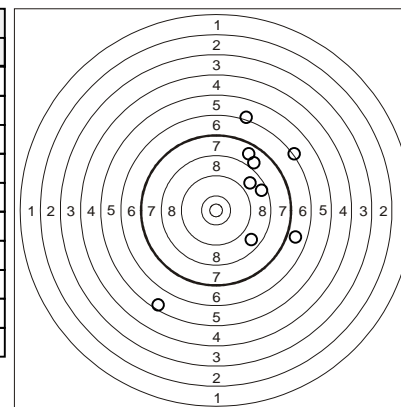

INDIVIDUAL SHOOTING RESULTS

WORLD CUP SOFIA2023 - WOMEN'S QUALIFICATION "A"

Charlie FOLLETT (GBR)

Heat 1			
	H	P	D
Tot	5/1/6	8,7	12,07
1	O	8,9	-
2	-	6,7	2,45
3	O	7,5	2,32
4	O	10,2	2,44
5	O	9,3	2,44
6	O	9,4	2,42

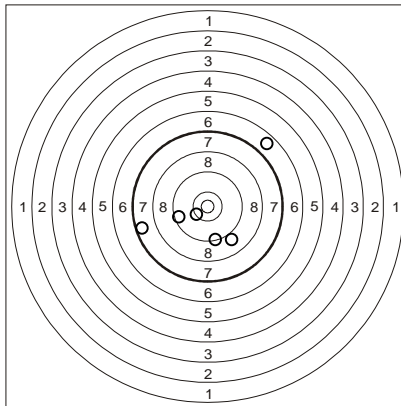

Heat 2			
	H	P	D
Tot	5/1/6	8,7	12,09
1	-	6,6	-
2	O	10,1	2,23
3	O	8,6	2,45
4	O	7,9	2,41
5	O	10,1	2,50
6	O	9,0	2,50

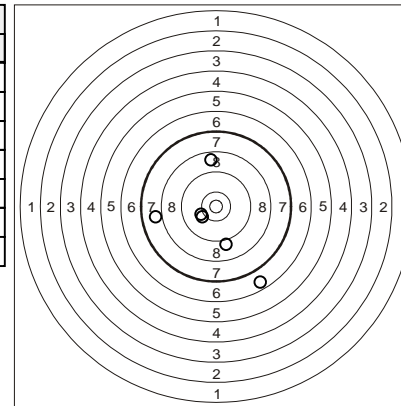

Heat 3			
	H	P	D
Tot	5/0/5	9,2	9,54
1	O	9,8	-
2	O	10,2	2,40
3	O	8,8	2,48
4	O	8,0	2,41
5	O	9,0	2,25

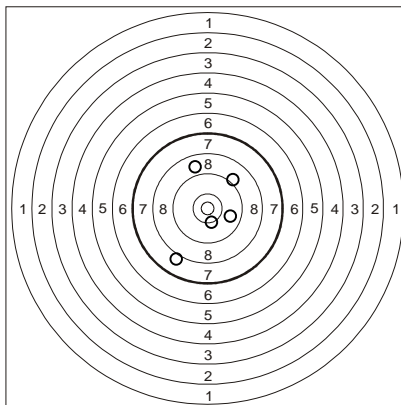

Heat 4			
	H	P	D
Tot	5/0/5	8,3	9,95
1	O	8,9	-
2	O	8,3	2,59
3	O	7,5	2,27
4	O	7,4	2,40
5	O	9,5	2,69

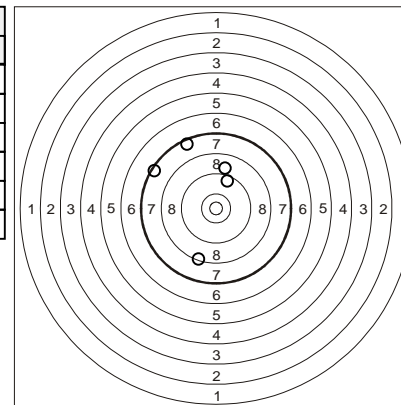

INDIVIDUAL SHOOTING RESULTS

WORLD CUP SOFIA2023 - WOMEN'S QUALIFICATION "A"

Annika ZILLEKENS (GER)

Heat 1			
	H	P	D
Tot	5/0/5	9,0	9,60
1	O	8,3	-
2	O	9,4	2,45
3	O	8,9	2,33
4	O	8,3	2,33
5	O	10,0	2,49

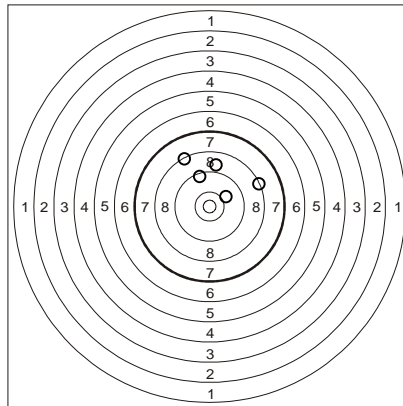

Heat 2			
	H	P	D
Tot	5/1/6	8,9	11,65
1	-	6,0	-
2	O	9,8	2,28
3	O	8,5	2,41
4	O	9,2	2,21
5	O	10,3	2,44
6	O	9,8	2,31

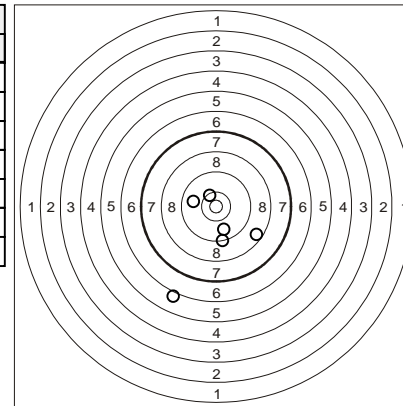

Heat 3			
	H	P	D
Tot	5/1/6	9,2	11,63
1	O	10,2	-
2	-	7,2	2,21
3	O	10,1	2,53
4	O	8,8	2,53
5	O	8,2	2,12
6	O	10,4	2,24

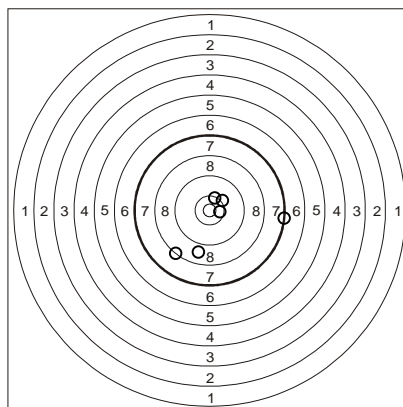

Heat 4			
	H	P	D
Tot	5/1/6	8,2	12,53
1	O	8,0	-
2	O	8,5	2,61
3	O	8,6	2,53
4	-	6,3	2,42
5	O	8,9	2,35
6	O	9,1	2,62

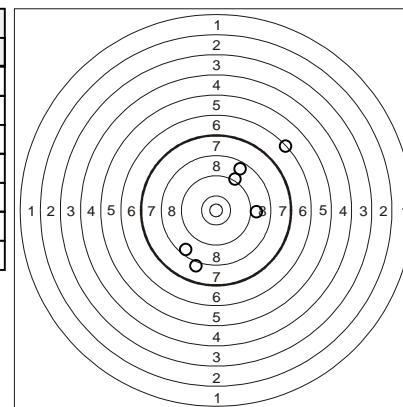

INDIVIDUAL SHOOTING RESULTS

WORLD CUP SOFIA2023 - WOMEN'S QUALIFICATION "A"

Kanae UMEMURA (JPN)

Heat 1			
	H	P	D
Tot	5/2/7	7,8	13,43
1	O	8,4	-
2	-	2,9	2,71
3	-	6,7	2,04
4	O	7,8	2,31
5	O	9,8	2,21
6	O	9,6	2,09
7	O	9,6	2,07

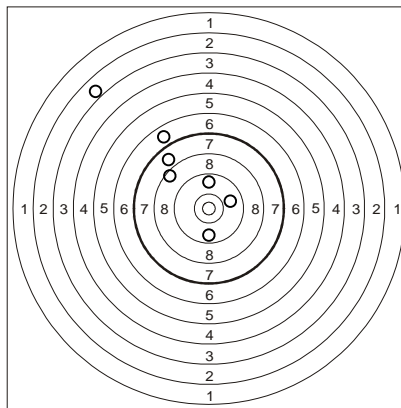

Heat 2			
	H	P	D
Tot	5/7/12	7,2	22,98
1	-	6,7	-
2	-	4,2	2,18
3	-	6,8	2,00
4	-	7,1	2,06
5	O	7,4	2,01
6	O	10,1	2,24
7	-	6,9	2,10
8	O	7,8	2,01
9	-	5,0	2,04
10	O	8,9	2,16
11	-	6,2	2,10
12	O	9,1	2,08

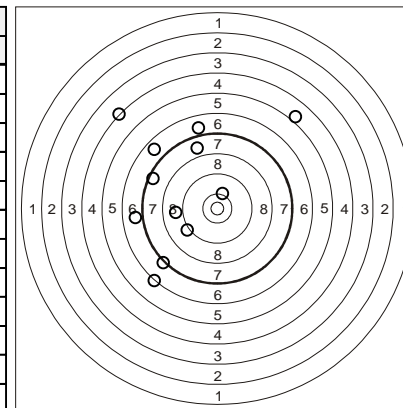

Heat 3			
	H	P	D
Tot	5/6/11	6,7	21,92
1	-	4,8	-
2	O	9,7	2,22
3	-	4,0	2,06
4	-	2,1	2,14
5	O	8,4	2,12
6	O	7,8	2,33
7	-	6,7	2,20
8	-	6,1	2,16
9	O	9,3	2,06
10	-	6,3	2,33
11	O	8,8	2,30

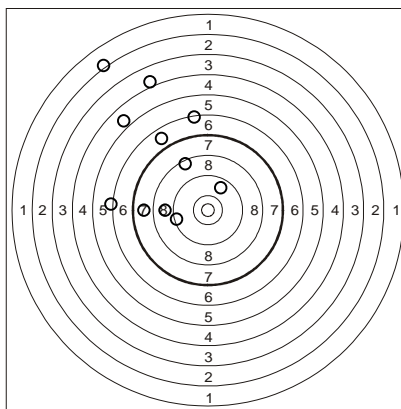

Heat 4			
	H	P	D
Tot	5/4/9	7,4	18,11
1	-	3,6	-
2	O	8,1	2,19
3	O	8,1	2,28
4	-	6,2	2,54
5	O	9,6	2,08
6	O	9,0	2,21
7	-	6,7	2,45
8	-	6,2	2,20
9	O	8,8	2,16

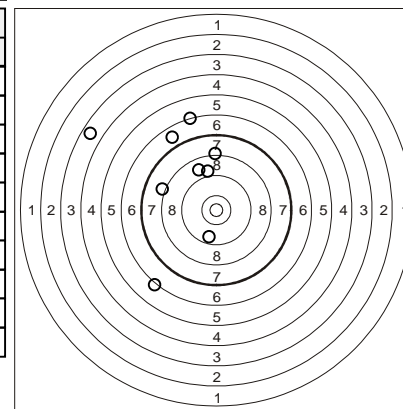

INDIVIDUAL SHOOTING RESULTS

WORLD CUP SOFIA2023 - WOMEN'S QUALIFICATION "A"

Marie OTEIZA (FRA)

Heat 1			
	H	P	D
Tot	5/2/7	8,0	14,87
1	-	6,3	-
2	O	8,0	2,32
3	O	7,5	2,69
4	-	6,3	2,38
5	O	9,7	2,69
6	O	8,6	2,31
7	O	9,5	2,48

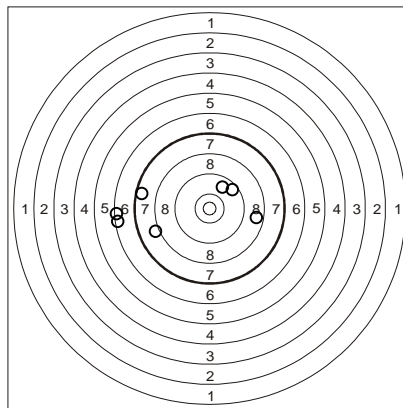

Heat 2			
	H	P	D
Tot	5/1/6	9,2	13,25
1	O	10,2	-
2	O	10,2	3,74
3	O	8,8	2,22
4	O	10,6	2,51
5	-	7,0	2,25
6	O	8,2	2,53

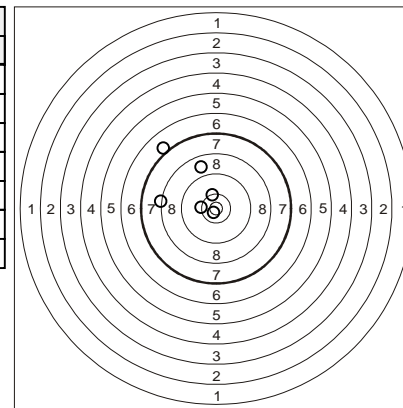

Heat 3			
	H	P	D
Tot	5/1/6	8,1	13,35
1	-	6,4	-
2	O	8,7	2,45
3	O	7,8	3,25
4	O	7,9	2,40
5	O	8,4	2,55
6	O	9,3	2,70

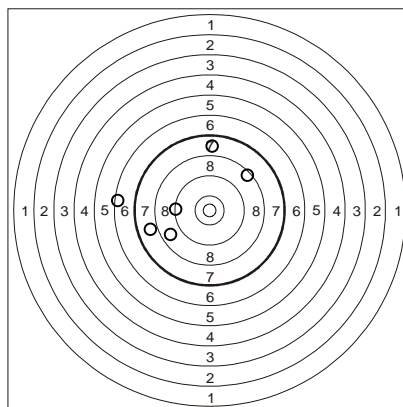

Heat 4			
	H	P	D
Tot	5/4/9	6,9	24,96
1	-	4,1	-
2	-	5,1	2,48
3	O	8,4	2,40
4	-	5,7	2,35
5	O	9,1	4,92
6	O	8,3	2,54
7	O	7,3	5,16
8	-	6,2	2,40
9	O	8,2	2,71

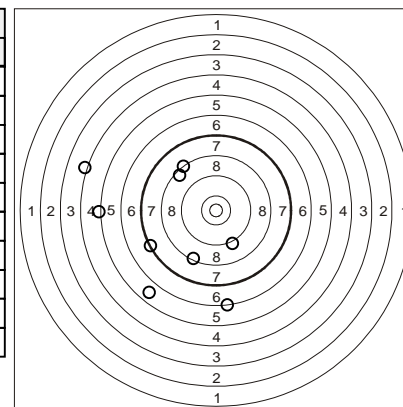

INDIVIDUAL SHOOTING RESULTS

WORLD CUP SOFIA2023 - WOMEN'S QUALIFICATION "A"

Haeun JANG (KOR)

Heat 1			
	H	P	D
Tot	5/3/8	7,6	13,98
1	O	9,0	-
2	O	8,9	1,93
3	-	6,2	2,10
4	-	6,9	1,93
5	O	7,8	1,93
6	O	7,9	2,02
7	-	5,6	1,89
8	O	8,2	2,18

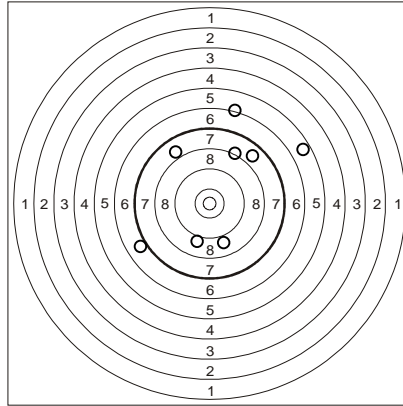

Heat 2			
	H	P	D
Tot	5/2/7	8,1	11,74
1	-	6,1	-
2	O	7,9	1,85
3	O	7,4	1,86
4	-	6,7	1,97
5	O	10,4	1,92
6	O	8,2	1,99
7	O	9,8	2,15

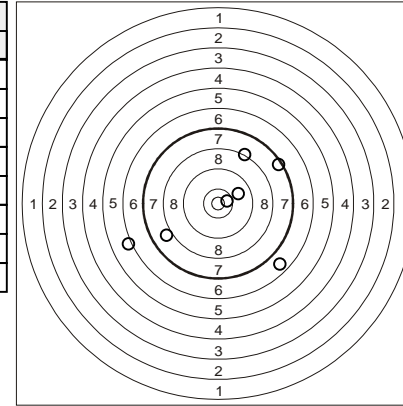

Heat 3			
	H	P	D
Tot	5/3/8	7,8	13,97
1	O	10,4	-
2	O	9,0	2,07
3	-	6,8	1,84
4	O	8,9	2,04
5	-	6,4	1,88
6	O	7,8	1,96
7	-	5,6	2,03
8	O	7,4	2,15

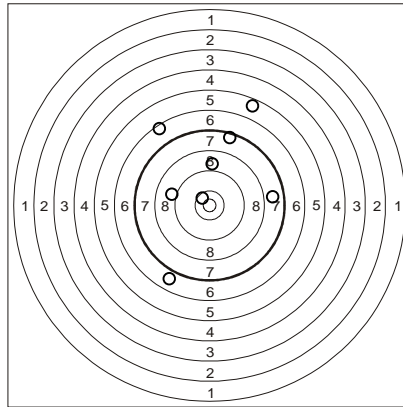

Heat 4			
	H	P	D
Tot	5/3/8	8,1	14,23
1	-	6,5	-
2	-	6,5	2,15
3	-	6,7	1,99
4	O	10,5	2,07
5	O	9,0	1,96
6	O	7,4	2,01
7	O	8,7	1,92
8	O	9,4	2,13

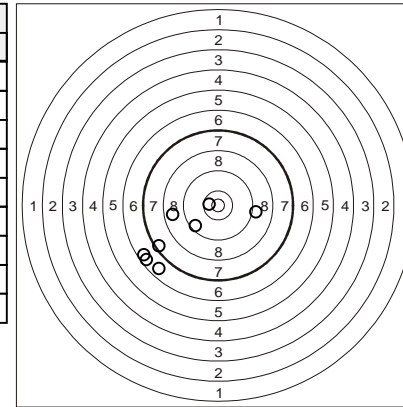

INDIVIDUAL SHOOTING RESULTS

WORLD CUP SOFIA2023 - WOMEN'S QUALIFICATION "A"

Anais EUDES (BEL)

Heat 1			
	H	P	D
Tot	5/3/8	6,6	15,36
1	-	2,2	-
2	-	7,0	2,28
3	O	7,3	2,28
4	O	9,2	2,22
5	O	8,2	2,12
6	-	2,9	2,12
7	O	7,5	2,20
8	O	8,1	2,14

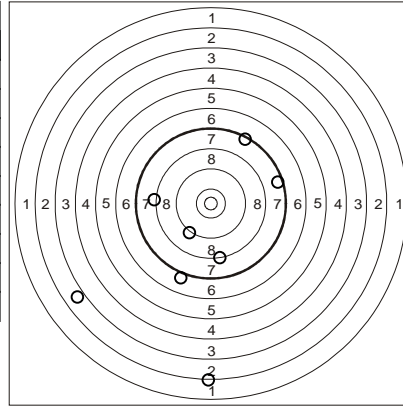

Heat 2			
	H	P	D
Tot	5/2/7	7,4	13,68
1	-	3,4	-
2	O	7,3	2,39
3	O	8,1	2,51
4	-	4,9	2,55
5	O	8,4	2,06
6	O	9,0	2,07
7	O	10,5	2,10

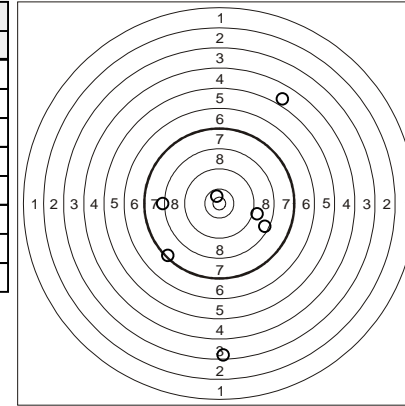

Heat 3			
	H	P	D
Tot	5/8/13	6,6	27,32
1	-	6,2	-
2	-	4,2	2,37
3	O	7,5	2,30
4	O	9,1	2,99
5	-	6,9	2,17
6	-	7,0	2,23
7	O	8,9	2,19
8	O	8,9	2,02
9	-	2,4	2,08
10	-	4,0	2,25
11	-	4,7	2,14
12	-	6,2	2,40
13	O	10,3	2,18

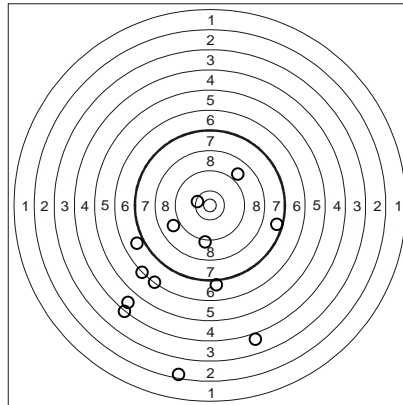

Heat 4			
	H	P	D
Tot	5/5/10	7,3	21,40
1	O	8,5	-
2	-	7,0	2,88
3	-	4,0	2,31
4	-	6,4	2,11
5	O	8,3	2,20
6	-	5,1	2,19
7	-	6,3	2,17
8	O	9,5	2,23
9	O	8,2	2,09
10	O	9,4	3,22

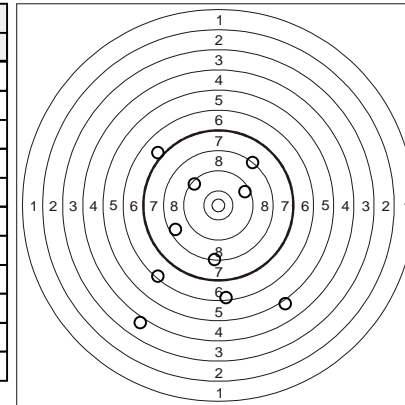

INDIVIDUAL SHOOTING RESULTS

WORLD CUP SOFIA2023 - WOMEN'S QUALIFICATION "A"

Mayan OLIVER (MEX)

Heat 1			
	H	P	D
Tot	5/3/8	7,7	16,17
1	O	9,4	-
2	-	4,8	2,21
3	-	5,4	2,39
4	O	8,5	2,37
5	O	8,7	2,36
6	-	7,1	2,39
7	O	8,3	2,24
8	O	9,5	2,21

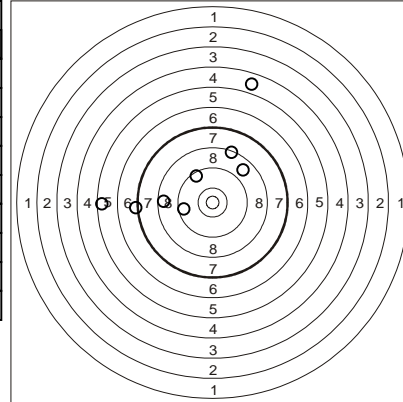

Heat 2			
	H	P	D
Tot	5/4/9	7,2	18,79
1	-	5,8	-
2	-	4,2	2,27
3	-	3,4	2,18
4	O	9,9	2,45
5	O	10,4	2,68
6	-	6,1	2,34
7	O	8,4	2,32
8	O	9,4	2,32
9	O	7,4	2,23

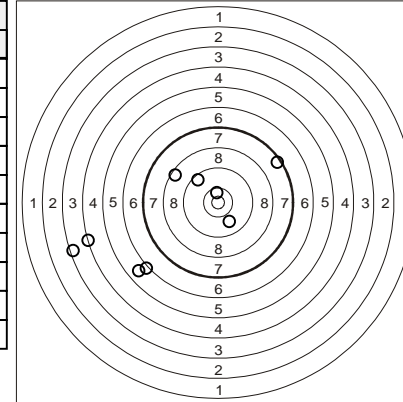

Heat 3			
	H	P	D
Tot	5/0/5	8,6	8,79
1	O	7,5	-
2	O	10,0	2,22
3	O	9,8	2,32
4	O	7,5	2,13
5	O	8,2	2,12

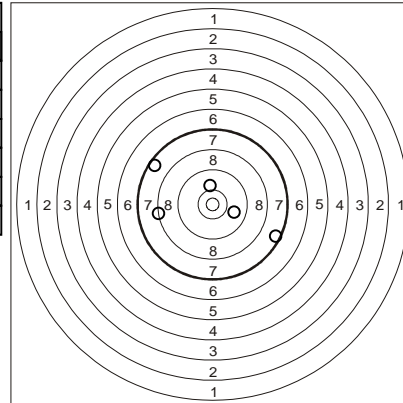

Heat 4			
	H	P	D
Tot	5/4/9	7,1	18,19
1	-	6,7	-
2	O	8,3	2,23
3	-	3,7	2,18
4	O	7,6	2,24
5	-	5,7	2,13
6	-	6,3	2,44
7	O	9,9	2,30
8	O	7,8	2,24
9	O	7,9	2,43

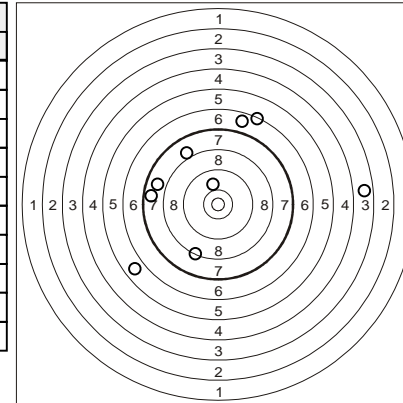

INDIVIDUAL SHOOTING RESULTS

WORLD CUP SOFIA2023 - WOMEN'S QUALIFICATION "A"

Emma WHITAKER (GBR)

Heat 1			
	H	P	D
Tot	5/3/8	7,5	16,05
1	-	6,2	-
2	-	6,4	2,32
3	O	10,0	2,42
4	O	7,5	2,42
5	O	8,0	2,20
6	-	5,4	2,13
7	O	8,5	2,30
8	O	8,3	2,26

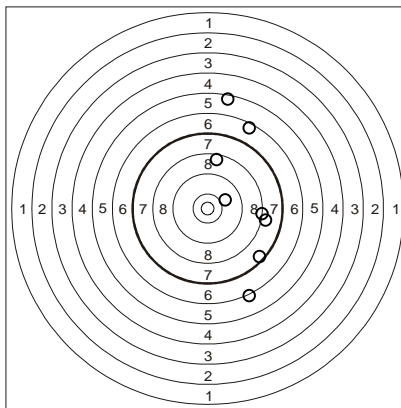

Heat 2			
	H	P	D
Tot	5/3/8	7,6	16,61
1	O	7,6	-
2	-	7,1	2,39
3	-	6,5	2,45
4	O	7,4	2,33
5	-	5,5	2,37
6	O	8,8	2,30
7	O	7,7	2,35
8	O	9,8	2,42

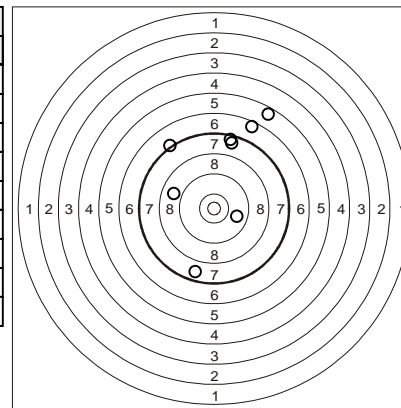

Heat 3			
	H	P	D
Tot	5/1/6	8,0	11,37
1	O	8,3	-
2	O	7,5	2,39
3	-	6,3	2,17
4	O	10,3	2,54
5	O	7,6	2,05
6	O	7,8	2,22

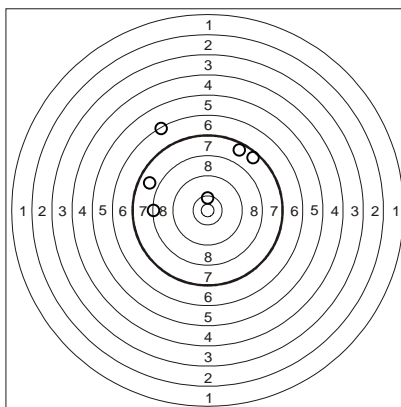

Heat 4			
	H	P	D
Tot	5/2/7	8,1	13,26
1	-	6,5	-
2	O	8,5	2,41
3	O	9,0	2,14
4	-	6,9	2,25
5	O	9,5	2,19
6	O	7,8	2,20
7	O	8,3	2,07

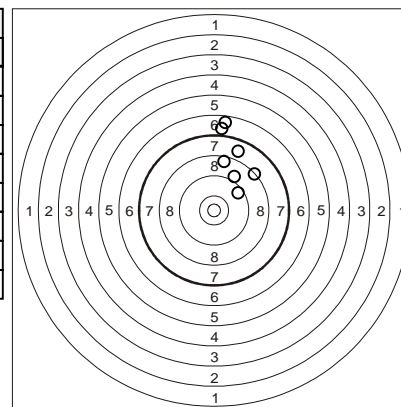

INDIVIDUAL SHOOTING RESULTS

WORLD CUP SOFIA2023 - WOMEN'S QUALIFICATION "A"

Laura ASADAUSKAITE (LTU)

Heat 1			
	H	P	D
Tot	5/0/5	8,4	8,11
1	O	8,2	-
2	O	8,0	2,01
3	O	9,1	2,11
4	O	9,0	1,95
5	O	7,6	2,04

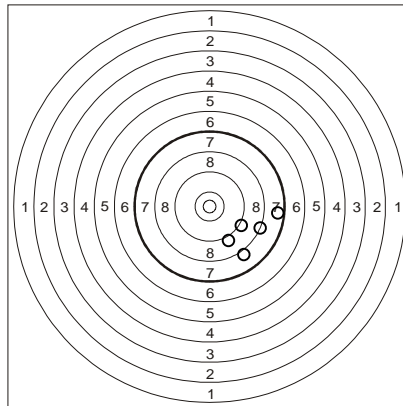

Heat 2			
	H	P	D
Tot	5/2/7	7,8	12,65
1	O	10,3	-
2	O	7,6	2,34
3	O	8,9	2,00
4	-	5,9	2,02
5	O	8,4	1,84
6	-	4,7	1,93
7	O	8,6	2,52

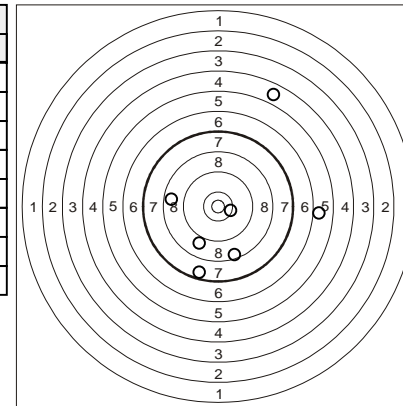

Heat 3			
	H	P	D
Tot	5/1/6	8,2	10,01
1	-	3,6	-
2	O	10,6	2,22
3	O	9,1	2,03
4	O	7,3	1,92
5	O	10,4	1,85
6	O	7,9	1,99

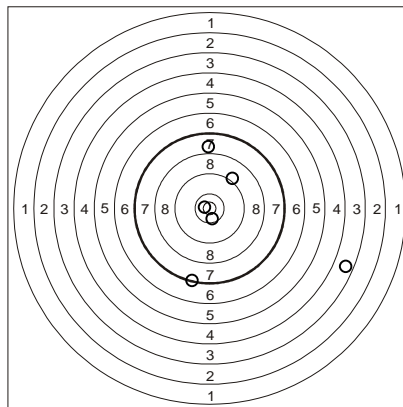

Heat 4			
	H	P	D
Tot	5/2/7	8,2	12,54
1	-	6,8	-
2	O	8,2	2,02
3	O	9,0	2,11
4	-	7,2	1,92
5	O	9,0	1,92
6	O	7,8	2,22
7	O	9,1	2,35

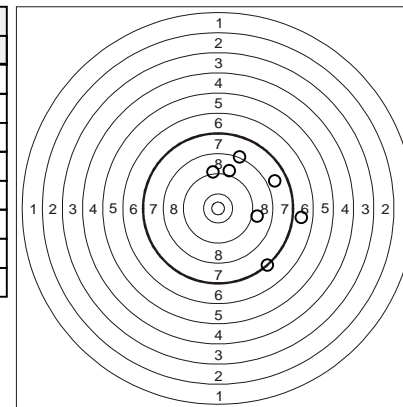

INDIVIDUAL SHOOTING RESULTS

WORLD CUP SOFIA2023 - WOMEN'S QUALIFICATION "A"

Elzbieta ADOMAITYTE (LTU)

Heat 1			
	H	P	D
Tot	5/1/6	8,5	12,59
1	O	7,6	-
2	O	9,5	2,17
3	O	9,7	2,15
4	-	6,4	4,10
5	O	9,7	2,02
6	O	8,3	2,15

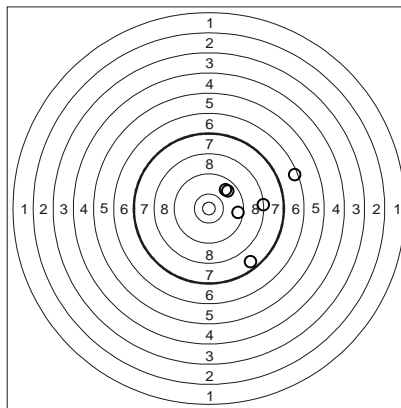

Heat 2			
	H	P	D
Tot	5/2/7	8,1	12,38
1	-	6,3	-
2	-	6,5	2,07
3	O	7,3	2,21
4	O	9,1	2,03
5	O	9,1	2,02
6	O	9,0	1,93
7	O	9,1	2,12

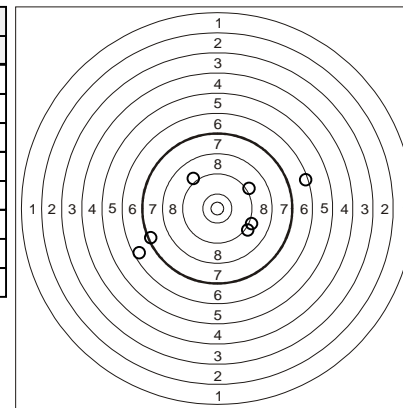

Heat 3			
	H	P	D
Tot	5/6/11	6,7	22,57
1	O	7,7	-
2	O	8,0	2,15
3	-	4,4	4,11
4	-	5,7	1,95
5	O	8,0	2,14
6	-	5,5	2,08
7	-	6,2	1,92
8	O	8,5	1,93
9	-	4,4	1,98
10	-	5,3	2,18
11	O	10,2	2,13

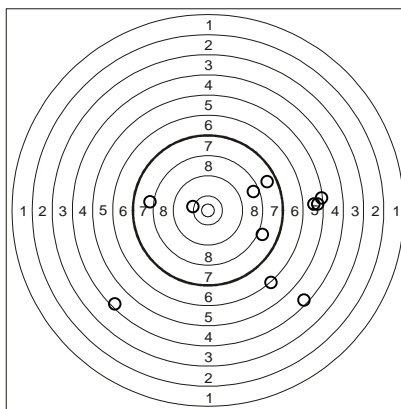

Heat 4			
	H	P	D
Tot	5/2/7	7,5	12,37
1	-	5,8	-
2	O	7,7	1,93
3	O	8,8	2,02
4	O	7,7	2,13
5	O	7,4	2,14
6	-	7,1	2,03
7	O	8,1	2,12

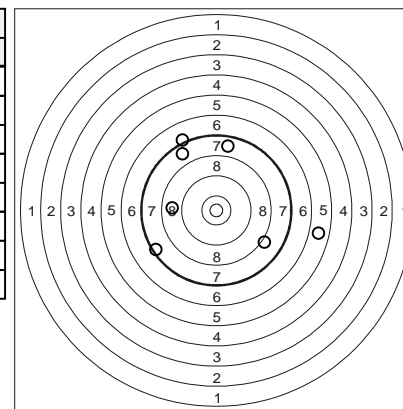

INDIVIDUAL SHOOTING RESULTS

WORLD CUP SOFIA2023 - WOMEN'S QUALIFICATION "A"

Barbora RAJNOCH (CZE)

Heat 1			
	H	P	D
Tot	5/3/8	7,3	13,37
1	-	4,5	-
2	-	4,5	1,92
3	O	9,5	2,04
4	O	8,4	1,92
5	-	6,4	1,83
6	O	9,3	1,99
7	O	8,2	1,82
8	O	7,5	1,85

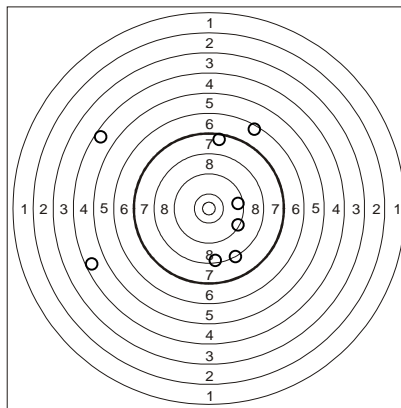

Heat 2			
	H	P	D
Tot	5/7/12	6,9	20,81
1	-	6,6	-
2	-	7,2	1,87
3	-	6,7	2,10
4	-	4,4	2,00
5	O	7,5	1,82
6	-	4,3	1,84
7	-	4,2	1,87
8	O	10,3	1,83
9	O	8,2	1,91
10	-	5,8	1,72
11	O	9,3	1,92
12	O	8,3	1,93

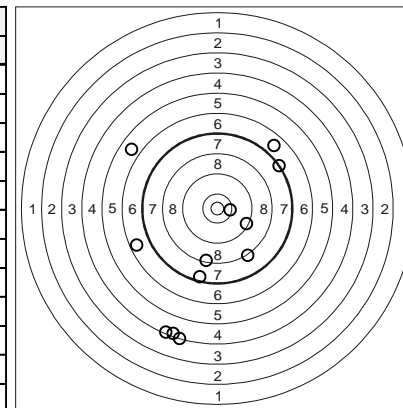

Heat 3			
	H	P	D
Tot	5/0/5	8,8	7,16
1	O	9,8	-
2	O	7,7	1,90
3	O	7,5	1,81
4	O	9,3	1,59
5	O	9,7	1,86

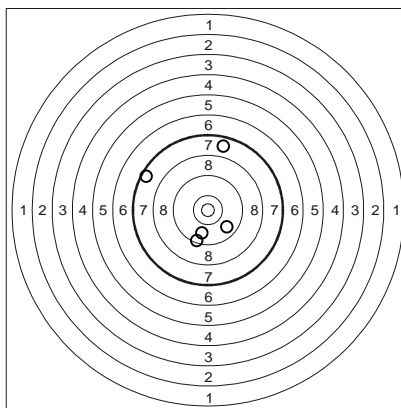

Heat 4			
	H	P	D
Tot	5/3/8	7,8	13,39
1	-	6,1	-
2	-	6,4	1,89
3	O	8,4	1,92
4	O	8,7	1,85
5	O	9,2	1,89
6	O	9,3	1,88
7	-	6,4	1,97
8	O	8,0	1,99

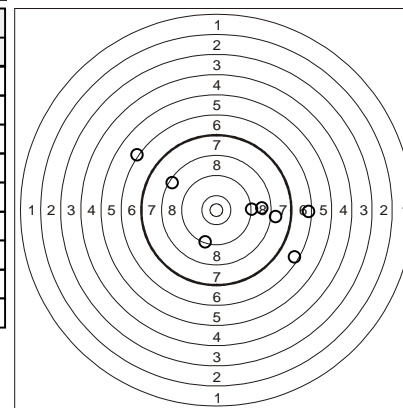

INDIVIDUAL SHOOTING RESULTS

WORLD CUP SOFIA2023 - WOMEN'S QUALIFICATION "A"

Aosi TANG (CHN)

Heat 1			
	H	P	D
Tot	5/0/5	8,6	7,69
1	O	8,6	-
2	O	7,7	1,88
3	O	8,4	2,07
4	O	9,4	1,79
5	O	9,1	1,95

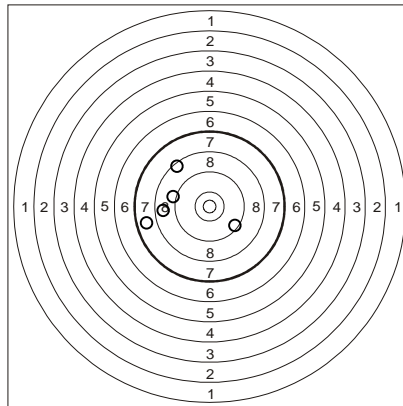

Heat 2			
	H	P	D
Tot	5/3/8	7,2	13,80
1	-	5,8	-
2	-	6,0	1,94
3	O	7,3	2,03
4	-	6,2	1,96
5	O	7,9	1,96
6	O	8,3	1,93
7	O	8,2	1,96
8	O	7,9	2,02

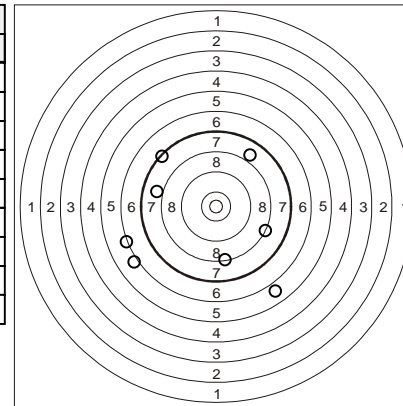

Heat 3			
	H	P	D
Tot	5/0/5	8,6	7,46
1	O	7,8	-
2	O	8,9	1,95
3	O	10,3	1,76
4	O	8,8	1,83
5	O	7,4	1,92

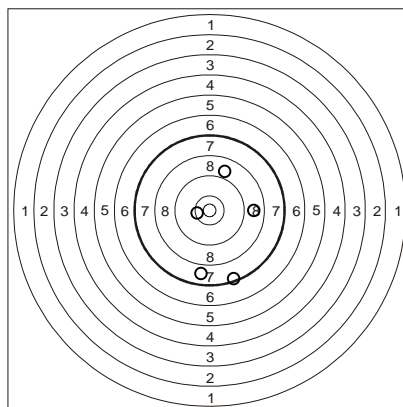

Heat 4			
	H	P	D
Tot	5/0/5	9,4	7,29
1	O	8,3	-
2	O	8,1	1,87
3	O	10,2	1,75
4	O	9,7	1,90
5	O	10,6	1,77

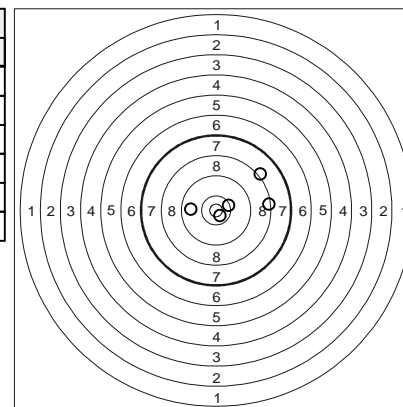

INDIVIDUAL SHOOTING RESULTS

WORLD CUP SOFIA2023 - WOMEN'S QUALIFICATION "A"

Catherine Mayran OLIVER (MEX)

Heat 1			
	H	P	D
Tot	5/3/8	7,9	12,45
1	O	8,3	-
2	-	7,2	1,82
3	O	9,9	1,71
4	-	6,0	1,72
5	O	7,6	1,90
6	O	9,7	1,71
7	-	5,6	1,81
8	O	9,2	1,78

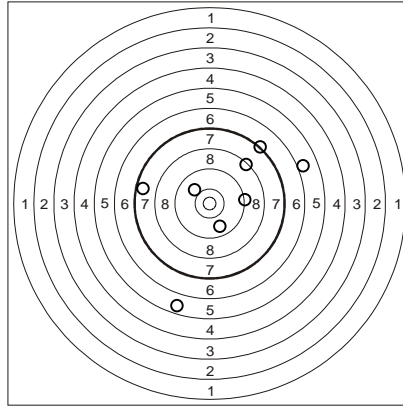

Heat 2			
	H	P	D
Tot	5/3/8	7,8	13,47
1	-	6,3	-
2	O	8,3	1,89
3	-	6,8	1,70
4	O	9,0	1,76
5	-	5,1	2,30
6	O	7,3	2,23
7	O	9,9	1,77
8	O	9,3	1,82

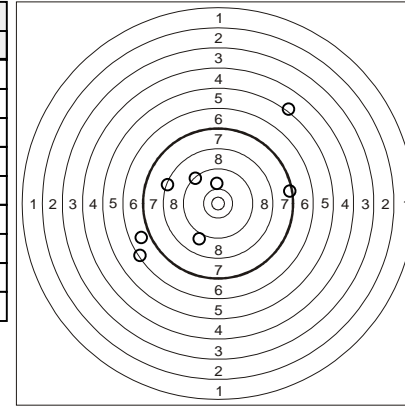

Heat 3			
	H	P	D
Tot	5/4/9	7,4	15,18
1	-	4,6	-
2	O	7,6	1,96
3	-	6,2	1,83
4	-	6,3	2,00
5	-	6,3	2,00
6	O	7,7	1,78
7	O	8,7	1,85
8	O	9,1	1,95
9	O	10,0	1,81

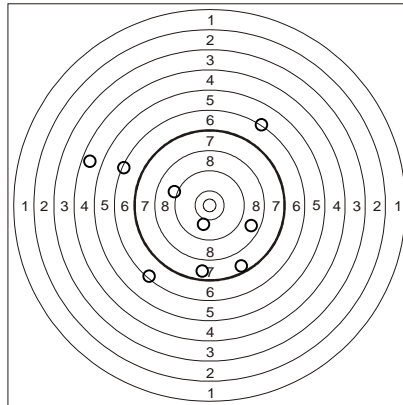

Heat 4			
	H	P	D
Tot	5/1/6	8,7	9,71
1	O	10,2	-
2	O	10,1	1,91
3	O	9,1	1,93
4	-	6,2	1,87
5	O	7,9	1,98
6	O	8,6	2,02

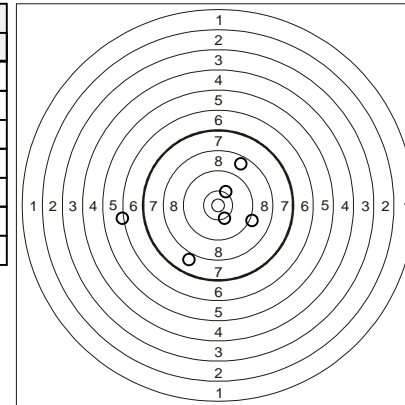

INDIVIDUAL SHOOTING RESULTS

WORLD CUP SOFIA2023 - WOMEN'S QUALIFICATION "A"

Luca BARTA (HUN)

Heat 1			
	H	P	D
Tot	5/7/12	6,8	22,97
1	O	7,6	-
2	-	6,3	2,13
3	-	6,9	2,10
4	-	5,4	2,12
5	-	6,1	2,04
6	O	7,9	2,11
7	-	6,6	2,05
8	O	7,7	2,06
9	-	5,2	2,17
10	O	7,5	2,02
11	-	4,3	1,98
12	O	10,2	2,19

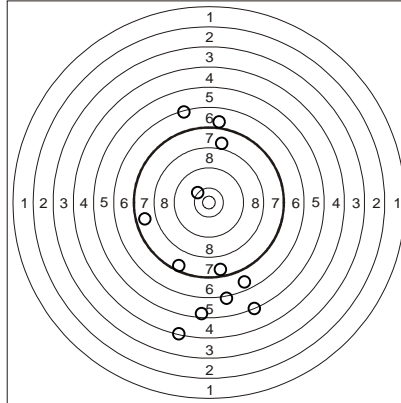

Heat 2			
	H	P	D
Tot	5/3/8	7,5	14,62
1	-	6,0	-
2	O	8,9	2,08
3	-	5,8	2,07
4	O	7,3	2,11
5	O	10,3	1,94
6	O	7,6	2,13
7	-	4,5	2,00
8	O	9,2	2,29

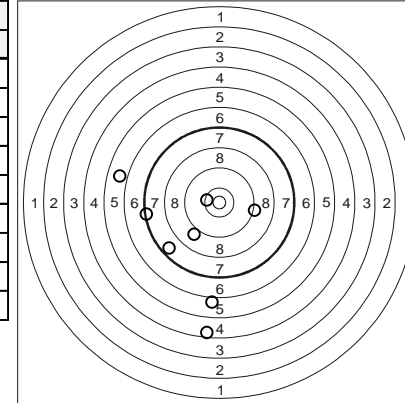

Heat 3			
	H	P	D
Tot	5/5/10	6,8	22,48
1	O	7,7	-
2	O	7,9	2,32
3	-	7,1	2,09
4	-	5,9	4,29
5	O	8,3	2,11
6	O	8,5	2,06
7	-	4,8	2,00
8	-	5,8	2,18
9	-	2,8	2,98
10	O	9,2	2,45

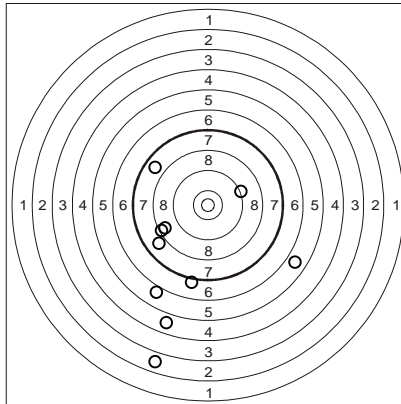

Heat 4			
	H	P	D
Tot	5/5/10	7,3	20,44
1	O	9,9	-
2	O	8,8	2,29
3	O	9,2	2,03
4	O	8,8	2,02
5	-	5,5	2,05
6	-	6,9	2,34
7	-	4,8	3,19
8	-	4,5	2,25
9	-	6,9	2,18
10	O	8,0	2,09

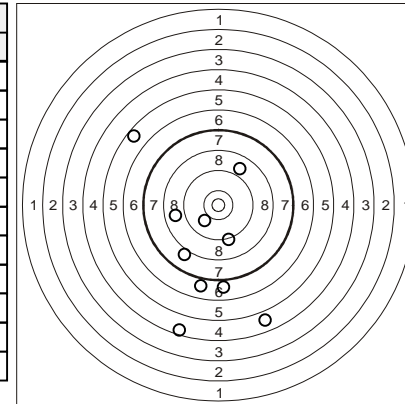

INDIVIDUAL SHOOTING RESULTS

WORLD CUP SOFIA2023 - WOMEN'S QUALIFICATION "A"

Ralitsa MITEVA (BUL)

Heat 1			
	H	P	D
Tot	5/5/10	6,9	16,27
1	-	6,5	-
2	O	7,6	1,73
3	O	9,3	1,51
4	O	7,9	1,83
5	-	2,9	1,71
6	-	4,5	1,91
7	-	6,4	1,91
8	-	6,9	2,01
9	O	8,4	1,72
10	O	8,7	1,94

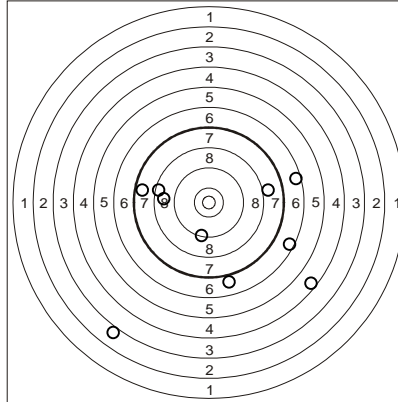

Heat 2			
	H	P	D
Tot	5/5/10	7,1	16,78
1	-	6,9	-
2	-	1,9	1,42
3	-	6,9	2,00
4	-	6,7	2,01
5	O	9,0	1,84
6	O	7,4	1,93
7	O	8,6	1,91
8	-	6,5	1,94
9	O	7,6	1,90
10	O	9,9	1,83

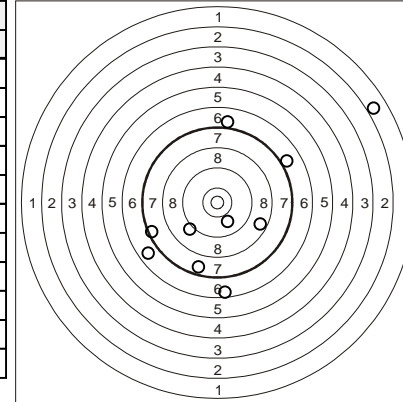

Heat 3			
	H	P	D
Tot	5/2/7	7,3	11,41
1	-	5,5	-
2	-	2,9	1,91
3	O	8,4	1,96
4	O	7,8	1,91
5	O	10,5	1,99
6	O	7,6	1,90
7	O	8,6	1,74

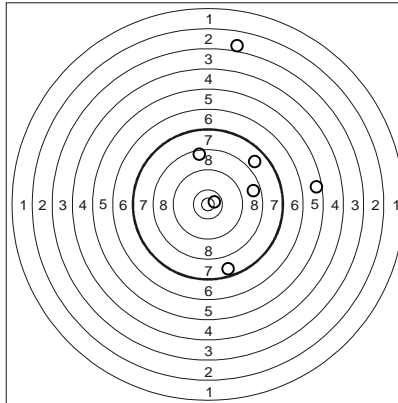

Heat 4			
	H	P	D
Tot	5/3/8	8,1	13,35
1	-	6,4	-
2	-	6,9	1,71
3	O	7,8	2,02
4	O	9,0	1,93
5	-	4,8	2,00
6	O	10,0	1,95
7	O	9,6	1,92
8	O	10,1	1,82

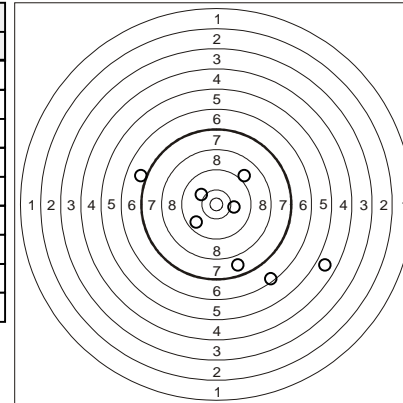

INDIVIDUAL SHOOTING RESULTS

WORLD CUP SOFIA2023 - WOMEN'S QUALIFICATION "A"

Kamilla RETI (HUN)

Heat 1			
	H	P	D
Tot	5/4/9	7,3	16,18
1	-	4,6	-
2	-	4,7	2,05
3	-	6,3	2,12
4	-	6,7	2,52
5	O	10,1	1,98
6	O	8,6	1,86
7	O	8,3	1,79
8	O	8,5	1,92
9	O	7,8	1,94

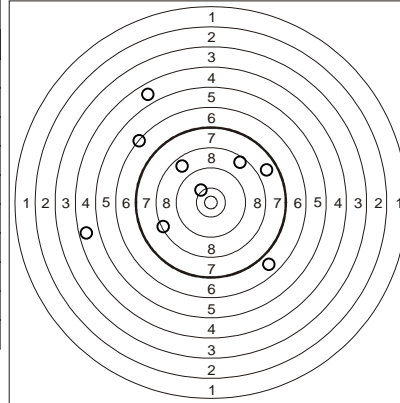

Heat 2			
	H	P	D
Tot	5/8/13	7,2	23,93
1	-	5,9	-
2	-	7,0	2,02
3	-	4,6	2,06
4	O	9,6	1,98
5	-	6,9	1,96
6	O	8,4	1,90
7	O	9,6	1,95
8	-	7,2	1,98
9	-	6,6	1,95
10	O	7,7	1,95
11	-	6,2	1,98
12	-	6,1	2,06
13	O	8,4	2,14

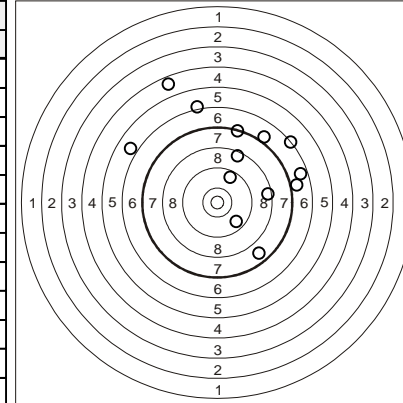

Heat 3			
	H	P	D
Tot	5/4/9	7,1	15,32
1	-	7,2	-
2	O	7,8	1,83
3	-	5,2	1,95
4	O	7,7	1,97
5	O	9,4	1,83
6	O	7,5	1,82
7	-	2,3	1,91
8	-	6,7	1,95
9	O	10,1	2,06

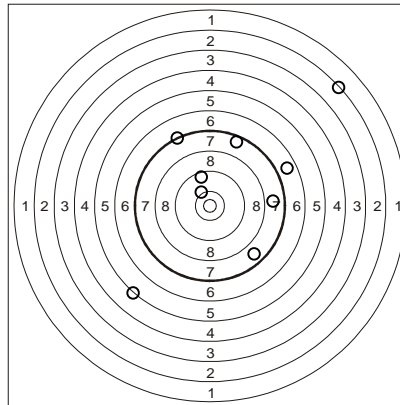

Heat 4			
	H	P	D
Tot	5/5/10	7,5	17,37
1	O	7,8	-
2	-	7,2	1,81
3	-	6,5	2,00
4	-	6,0	1,94
5	-	6,6	2,02
6	O	8,9	1,82
7	-	3,7	1,92
8	O	9,4	1,90
9	O	9,3	1,99
10	O	9,7	1,97

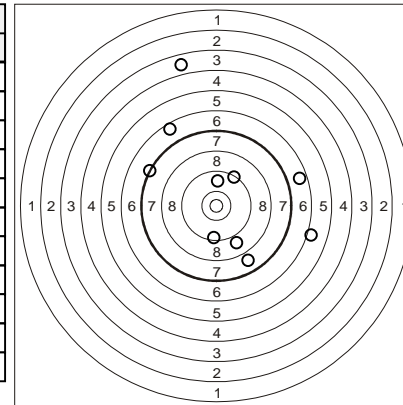

INDIVIDUAL SHOOTING RESULTS

WORLD CUP SOFIA2023 - WOMEN'S QUALIFICATION "A"

Soyoka TAGUCHI (JPN)

Heat 1			
	H	P	D
Tot	5/12/17	6,4	30,80
1	-	2,9	-
2	-	6,0	1,90
3	-	6,1	1,82
4	-	1,6	1,83
5	-	6,0	1,81
6	-	5,9	1,73
7	-	4,5	1,75
8	-	6,3	1,82
9	O	9,7	1,82
10	O	9,0	1,74
11	-	5,0	1,90
12	O	9,6	1,87
13	-	2,7	1,80
14	-	7,0	3,50
15	O	9,8	1,81
16	-	6,5	1,87
17	O	9,6	1,83

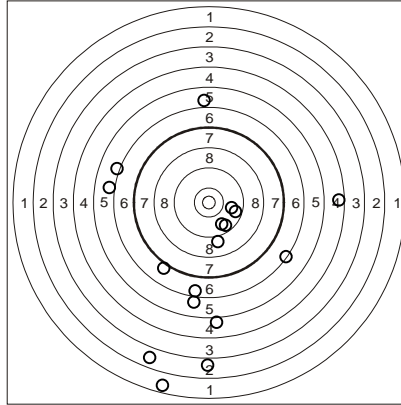

Heat 2			
	H	P	D
Tot	5/5/10	6,8	16,48
1	-	2,2	-
2	-	7,2	1,90
3	O	8,4	1,81
4	O	9,3	1,72
5	-	2,2	1,83
6	-	6,6	1,81
7	O	9,1	1,83
8	O	9,3	1,85
9	-	5,2	1,79
10	O	8,7	1,94

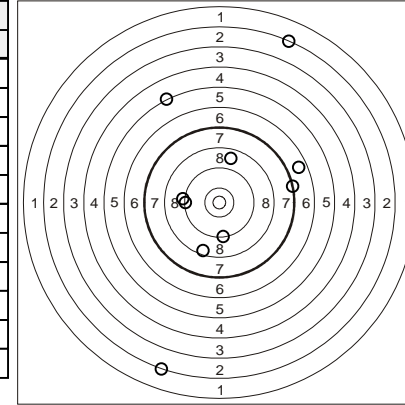

Heat 3			
	H	P	D
Tot	5/12/17	6,6	29,31
1	-	4,9	-
2	-	5,2	1,85
3	-	1,4	1,84
4	-	5,9	1,93
5	-	6,9	1,92
6	-	7,1	1,81
7	-	6,9	1,81
8	O	9,2	1,82
9	-	6,7	1,80
10	-	5,9	1,73
11	O	9,3	1,73
12	O	8,2	1,74
13	O	7,4	1,83
14	-	6,8	1,71
15	-	6,0	1,84
16	-	6,5	1,80
17	O	8,3	2,15

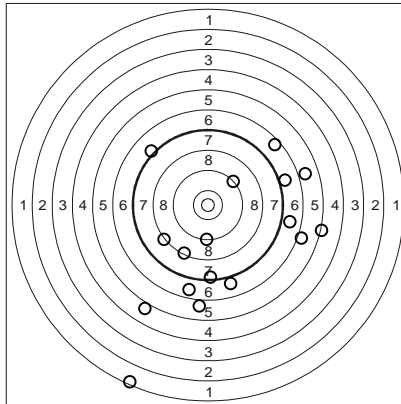

Heat 4			
	H	P	D
Tot	5/5/10	6,5	15,65
1	O	7,4	-
2	-	7,2	1,89
3	O	7,6	1,72
4	O	7,3	1,64
5	-	6,6	1,71
6	-	3,1	1,72
7	O	7,4	1,72
8	-	7,0	1,84
9	-	3,6	1,69
10	O	7,5	1,72

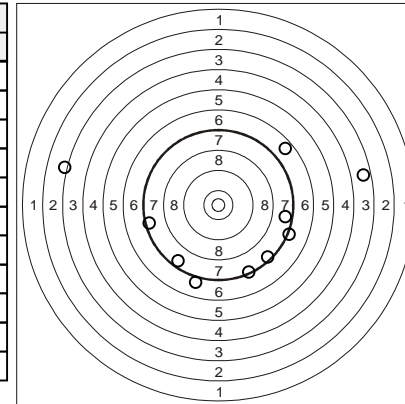

INDIVIDUAL SHOOTING RESULTS

WORLD CUP SOFIA2023 - WOMEN'S QUALIFICATION "A"

Kelly FITZSIMMONS (CAN)

Heat 1			
	H	P	D
Tot	5/8/13	5,7	27,90
1	O	9,5	-
2	-	1,7	1,95
3	-	3,0	2,20
4	-	2,1	2,44
5	O	7,3	2,28
6	-	5,9	2,36
7	O	7,6	2,23
8	-	2,6	2,20
9	-	6,6	2,22
10	O	8,8	3,26
11	-	5,3	2,11
12	-	5,7	2,21
13	O	8,0	2,44

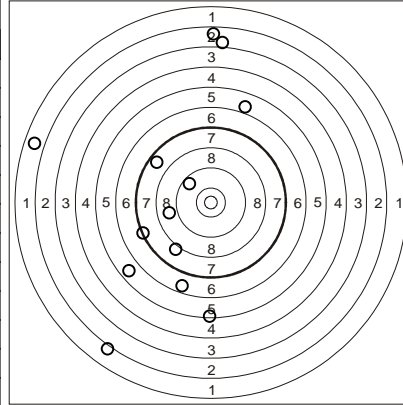

Heat 2			
	H	P	D
Tot	5/4/9	7,0	18,63
1	O	7,9	-
2	O	8,5	2,49
3	-	7,0	2,58
4	O	9,0	2,33
5	-	3,6	2,25
6	-	2,3	2,22
7	-	4,6	2,41
8	O	10,2	2,33
9	O	10,0	2,02

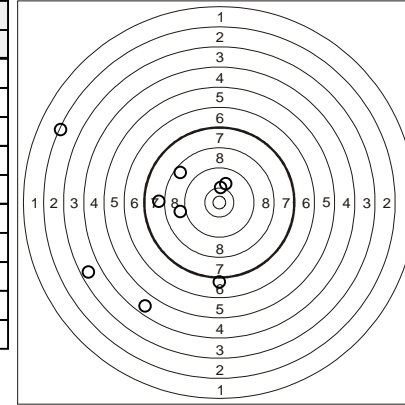

Heat 3			
	H	P	D
Tot	5/4/9	7,7	20,50
1	O	8,8	-
2	O	7,5	2,54
3	-	7,2	2,80
4	-	6,8	2,44
5	O	9,3	2,51
6	-	4,5	2,55
7	O	8,2	2,82
8	-	6,9	2,32
9	O	10,1	2,52

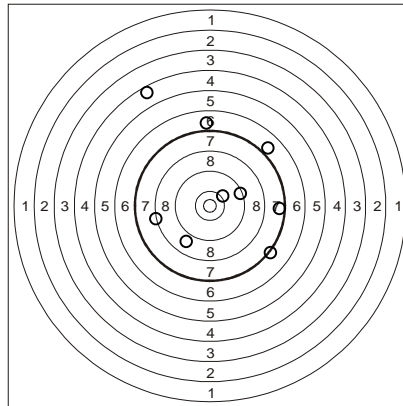

Heat 4			
	H	P	D
Tot	5/3/8	8,4	17,89
1	-	6,5	-
2	O	10,4	2,74
3	O	9,6	2,33
4	O	9,2	2,32
5	-	4,7	2,91
6	-	6,5	2,27
7	O	10,2	2,59
8	O	10,4	2,73

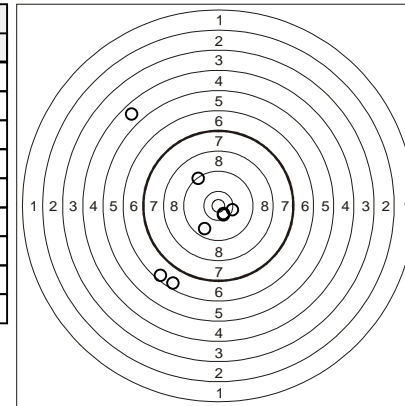

INDIVIDUAL SHOOTING RESULTS

WORLD CUP SOFIA2023 - WOMEN'S QUALIFICATION "A"

Madison GONZALEZ (USA)

Heat 1			
	H	P	D
Tot	5/3/8	7,0	12,87
1	O	7,6	-
2	O	8,9	1,92
3	O	9,1	1,80
4	-	5,9	1,81
5	-	4,0	1,85
6	-	3,6	1,77
7	O	8,1	1,77
8	O	8,9	1,95

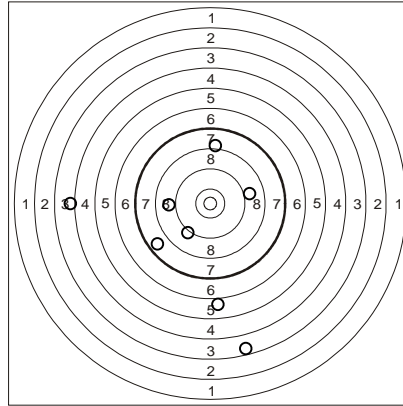

Heat 2			
	H	P	D
Tot	5/18/23	5,5	45,05
1	-	3,9	-
2	-	6,8	1,69
3	O	8,9	2,07
4	-	2,9	1,81
5	-	5,7	2,39
6	-	0,0	1,83
7	-	5,9	1,97
8	-	6,8	1,85
9	-	7,1	1,98
10	O	7,6	1,87
11	O	8,7	1,85
12	-	6,7	1,88
13	-	6,3	1,93
14	-	4,6	1,62
15	O	9,0	2,15
16	-	5,4	2,16
17	-	3,1	2,07
18	-	6,1	2,40
19	-	4,0	2,26
20	-	5,9	2,18
21	-	1,5	2,43
22	-	1,0	2,31
23	O	9,4	2,35

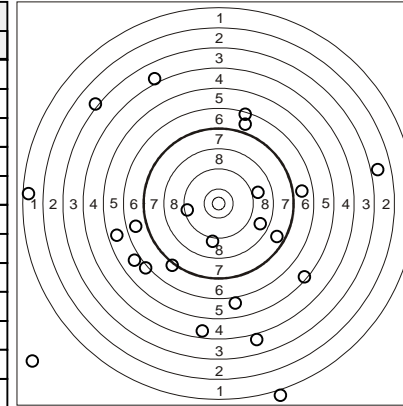

Heat 3			
	H	P	D
Tot	5/12/17	5,6	35,53
1	-	0,0	-
2	-	2,7	1,95
3	-	6,6	1,90
4	-	2,7	1,84
5	O	8,3	1,79
6	-	2,3	1,78
7	-	6,5	1,96
8	-	6,6	3,88
9	-	5,2	1,96
10	-	5,4	2,26
11	O	7,6	2,24
12	O	7,8	2,19

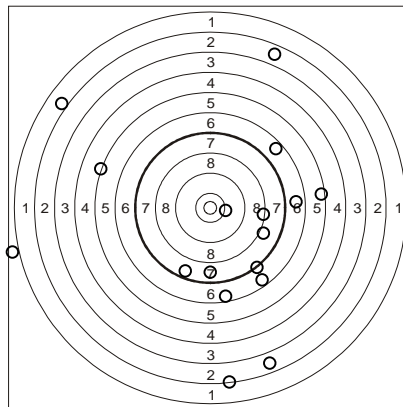

Heat 4			
	H	P	D
Tot	4/20/24	6,3	50,02
1	O	7,9	-
2	-	7,1	1,89
3	O	8,8	1,77
4	-	5,4	2,14
5	-	4,7	1,73
6	-	6,7	1,69
7	O	9,6	1,90
8	-	5,9	1,92
9	-	7,0	1,74
10	-	6,8	1,95
11	-	6,4	2,33
12	-	5,9	2,10

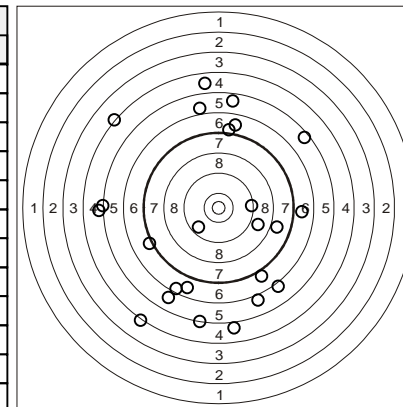

INDIVIDUAL SHOOTING RESULTS

WORLD CUP SOFIA2023 - WOMEN'S QUALIFICATION "A"

Isabela ABREU (BRA)

Heat 1			
	H	P	D
Tot	5/3/8	7,0	17,13
1	O	9,6	-
2	-	4,3	2,45
3	O	8,9	2,54
4	O	9,9	2,51
5	-	4,1	2,25
6	O	9,5	2,53
7	-	1,8	2,24
8	O	7,5	2,61

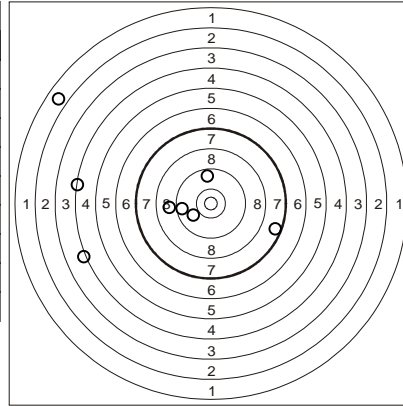

Heat 2			
	H	P	D
Tot	5/4/9	7,7	20,75
1	-	6,8	-
2	-	6,3	2,76
3	-	6,6	2,81
4	-	6,7	2,54
5	O	7,8	2,52
6	O	7,7	2,63
7	O	9,2	2,52
8	O	9,0	2,24
9	O	9,1	2,73

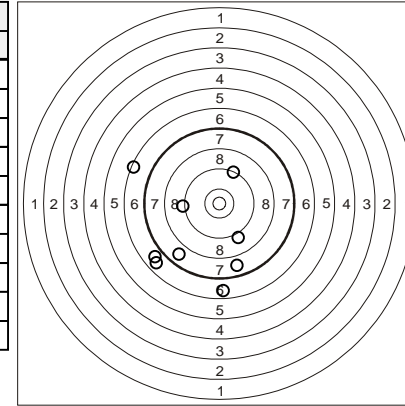

Heat 3			
	H	P	D
Tot	5/2/7	7,8	17,05
1	O	8,8	-
2	-	4,9	2,46
3	O	9,2	2,68
4	-	6,8	2,45
5	O	9,3	2,47
6	O	7,6	4,64
7	O	7,9	2,35

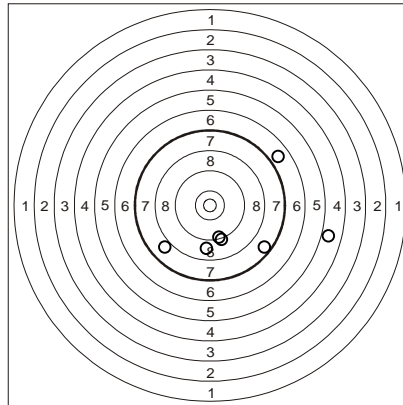

Heat 4			
	H	P	D
Tot	5/5/10	7,5	22,27
1	-	6,5	-
2	-	5,6	2,62
3	O	7,7	2,53
4	O	7,6	2,60
5	-	7,1	2,55
6	-	5,0	2,65
7	-	5,1	2,31
8	O	10,0	2,25
9	O	10,2	2,50
10	O	10,0	2,26

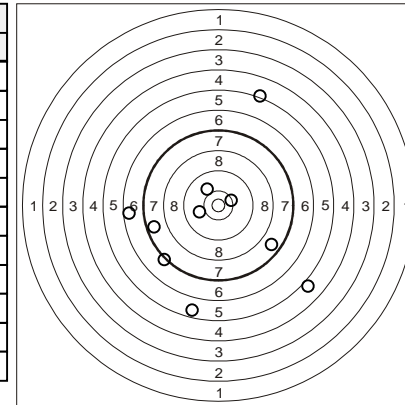

INDIVIDUAL SHOOTING RESULTS

WORLD CUP SOFIA2023 - WOMEN'S QUALIFICATION "A"

Mariia SHTUKINA (KGZ)

Heat 1			
	H	P	D
Tot	5/6/11	7,0	29,39
1	O	7,3	-
2	O	9,3	2,84
3	-	6,9	2,72
4	-	4,3	2,74
5	-	6,8	3,31
6	O	8,9	2,87
7	-	6,8	2,73
8	-	3,1	2,81
9	-	5,5	2,90
10	O	9,0	3,30
11	O	9,4	3,17

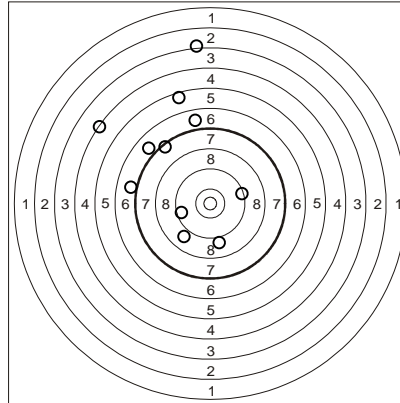

Heat 2			
	H	P	D
Tot	5/7/12	6,9	37,61
1	O	7,6	-
2	O	9,3	3,25
3	-	7,2	3,20
4	-	7,1	3,00
5	-	5,8	3,46
6	-	4,4	4,43
7	O	9,0	3,52
8	O	10,2	3,35
9	-	2,5	3,34
10	-	6,2	3,53
11	-	5,7	3,16
12	O	7,8	3,37

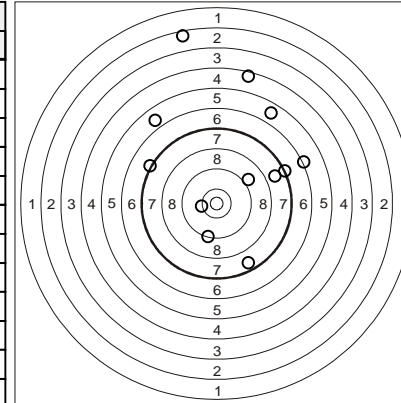

Heat 3			
	H	P	D
Tot	2/10/12	6,2	49,99
1	O	10,6	-
2	-	4,0	3,46
3	-	6,0	4,85
4	-	4,8	3,13
5	-	6,6	6,66
6	O	9,3	3,15
7	-	5,9	3,33
8	-	5,3	4,22
9	-	4,2	3,14
10	-	7,0	3,99
11	-	5,9	5,41
12	-	5,1	3,42

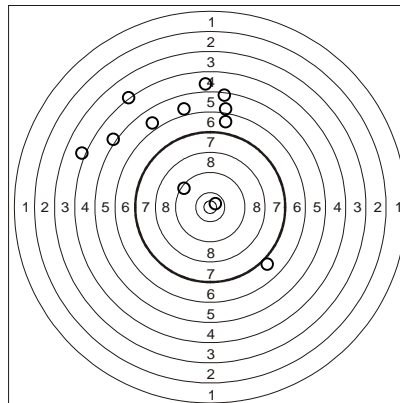

Heat 4			
	H	P	D
Tot	1/8/9	4,9	49,99
1	-	4,0	-
2	-	4,9	3,05
3	-	6,9	5,19
4	O	7,4	3,36
5	-	6,7	3,45
6	-	3,6	3,23
7	-	4,7	3,37
8	-	3,2	3,33
9	-	3,1	3,31

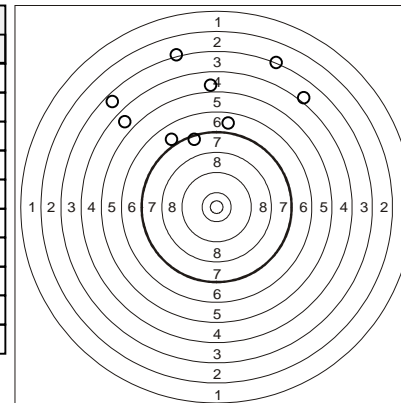

INDIVIDUAL SHOOTING RESULTS

WORLD CUP SOFIA2023 - WOMEN'S QUALIFICATION "A"

Dimana STEFANOVA (BUL)

Heat 1			
	H	P	D
Tot	5/0/5	9,4	8,31
1	O	9,8	-
2	O	9,6	2,20
3	O	10,2	2,02
4	O	9,9	1,93
5	O	7,6	2,16

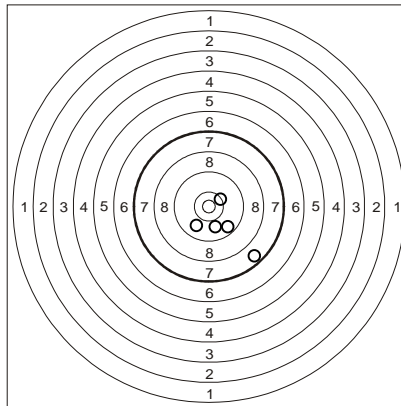

Heat 2			
	H	P	D
Tot	5/3/8	6,8	15,02
1	-	2,7	-
2	O	7,8	2,23
3	-	5,9	2,02
4	O	9,8	2,16
5	-	2,3	2,07
6	O	10,2	2,38
7	O	7,4	2,03
8	O	8,5	2,13

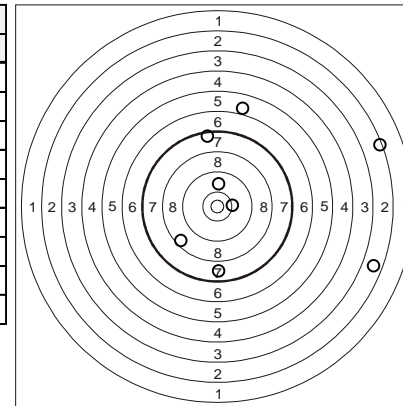

Heat 3			
	H	P	D
Tot	5/8/13	6,1	29,31
1	-	0,0	-
2	-	3,3	2,24
3	-	4,7	2,53
4	-	7,2	3,13
5	O	9,0	2,51
6	O	7,5	2,04
7	O	8,8	2,03
8	-	6,9	2,21
9	-	4,6	2,23
10	O	10,2	3,23
11	-	3,5	2,27
12	-	5,1	2,41
13	O	8,1	2,48

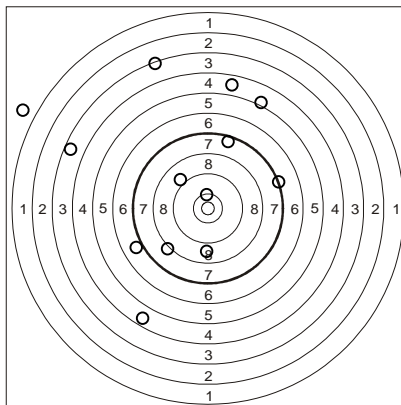

Heat 4			
	H	P	D
Tot	5/4/9	7,4	18,35
1	-	6,1	-
2	O	8,2	2,16
3	O	8,3	2,10
4	-	6,6	1,87
5	O	8,0	2,10
6	-	6,5	2,13
7	-	5,0	2,86
8	O	9,0	2,50
9	O	8,8	2,63

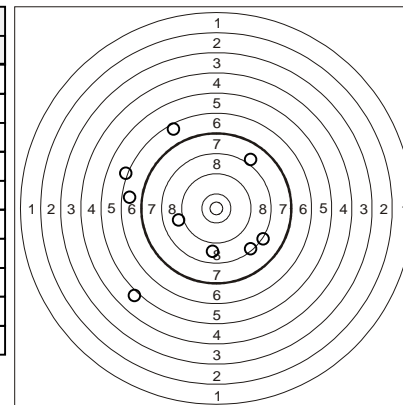

INDIVIDUAL SHOOTING RESULTS

WORLD CUP SOFIA2023 - WOMEN'S QUALIFICATION "A"

Phaelen FRENCH (USA)

Heat 1			
	H	P	D
Tot	5/3/8	7,5	18,41
1	O	9,5	-
2	-	6,7	2,43
3	O	8,2	2,44
4	-	6,7	2,83
5	O	7,6	2,40
6	O	8,7	2,67
7	-	3,6	2,79
8	O	9,1	2,85

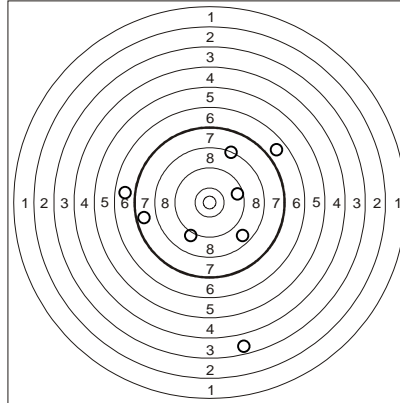

Heat 2			
	H	P	D
Tot	5/3/8	7,4	17,33
1	O	8,3	-
2	-	5,2	2,29
3	-	6,8	2,27
4	O	8,3	2,23
5	O	7,4	2,50
6	O	9,1	2,82
7	-	6,1	2,61
8	O	8,3	2,61

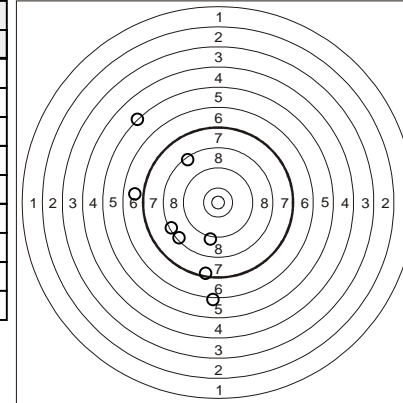

Heat 3			
	H	P	D
Tot	5/3/8	8,0	17,64
1	O	7,6	-
2	O	9,6	2,58
3	-	7,1	2,32
4	-	5,7	2,58
5	O	8,5	2,64
6	-	7,0	2,50
7	O	9,9	2,39
8	O	8,5	2,63

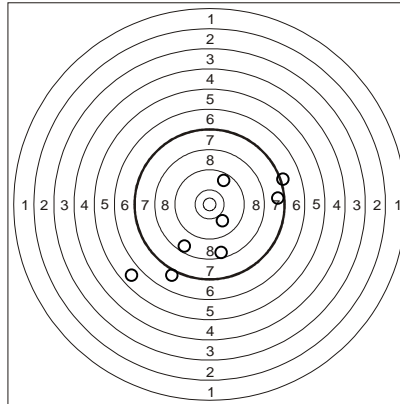

Heat 4			
	H	P	D
Tot	5/0/5	9,6	10,34
1	O	10,2	-
2	O	10,1	3,02
3	O	9,0	2,30
4	O	10,3	2,47
5	O	8,4	2,55

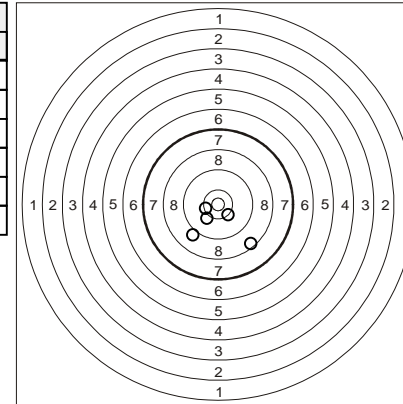

INDIVIDUAL SHOOTING RESULTS

WORLD CUP SOFIA2023 - WOMEN'S QUALIFICATION "A"

Pinelopi NIKA (GRE)

Heat 1			
	H	P	D
Tot	5/6/11	7,0	23,01
1	O	8,4	-
2	-	5,8	1,86
3	O	8,6	2,01
4	-	3,5	2,82
5	-	5,3	2,14
6	-	6,8	2,02
7	-	5,1	3,65
8	O	9,8	1,99
9	-	6,1	1,95
10	O	8,2	2,61
11	O	8,9	1,96

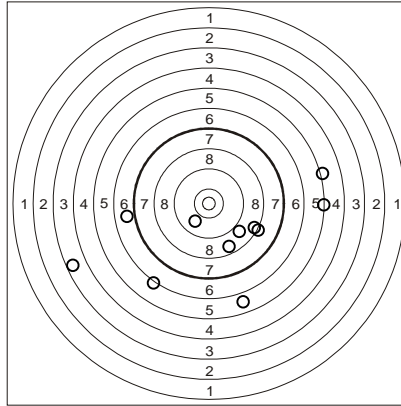

Heat 2			
	H	P	D
Tot	5/0/5	7,7	8,70
1	O	8,7	-
2	O	7,3	2,43
3	O	7,4	2,02
4	O	7,5	2,01
5	O	7,8	2,24

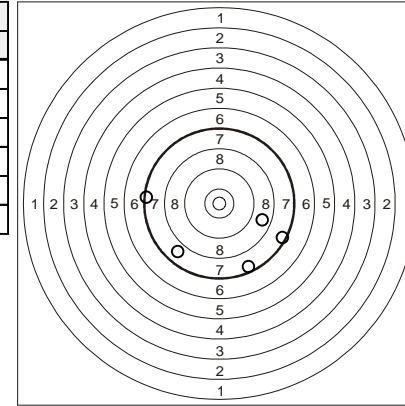

Heat 3			
	H	P	D
Tot	5/3/8	8,1	14,19
1	O	8,5	-
2	-	7,1	1,93
3	-	6,6	2,03
4	O	9,2	1,89
5	O	7,6	2,07
6	-	5,8	2,15
7	O	10,3	2,07
8	O	9,4	2,05

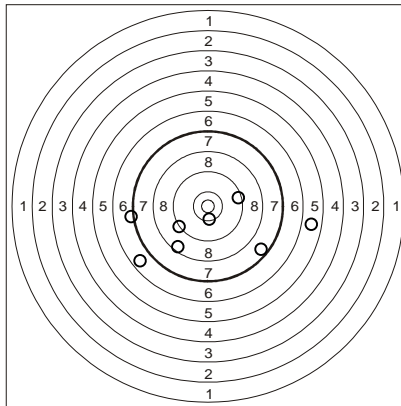

Heat 4			
	H	P	D
Tot	5/4/9	6,3	16,91
1	-	0,0	-
2	O	9,2	2,11
3	-	4,0	2,20
4	O	9,7	2,03
5	-	2,4	2,04
6	-	6,2	2,13
7	O	9,2	2,02
8	O	8,1	2,23
9	O	7,5	2,15

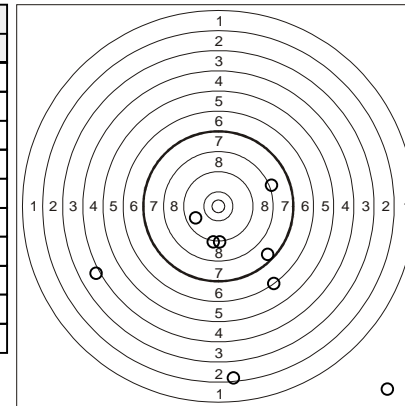

INDIVIDUAL SHOOTING RESULTS

WORLD CUP SOFIA2023 - WOMEN'S QUALIFICATION "A"

0

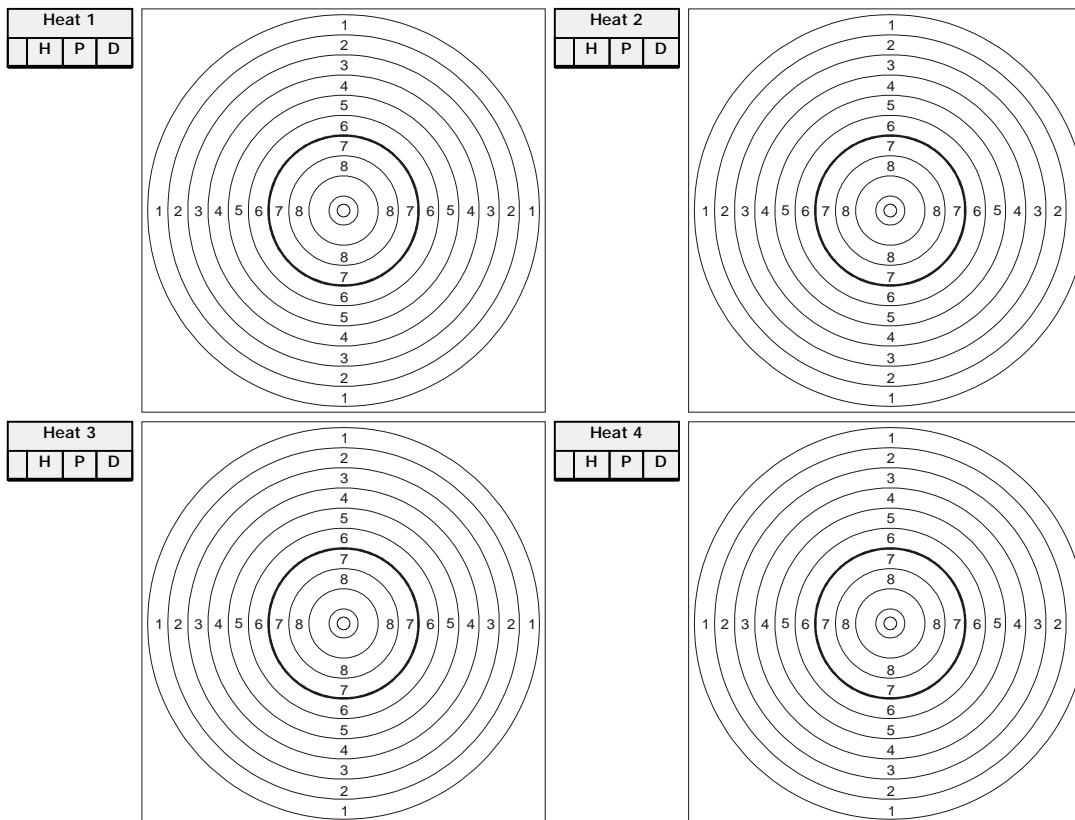

INDIVIDUAL SHOOTING RESULTS

WORLD CUP SOFIA2023 - WOMEN'S QUALIFICATION "A"

0

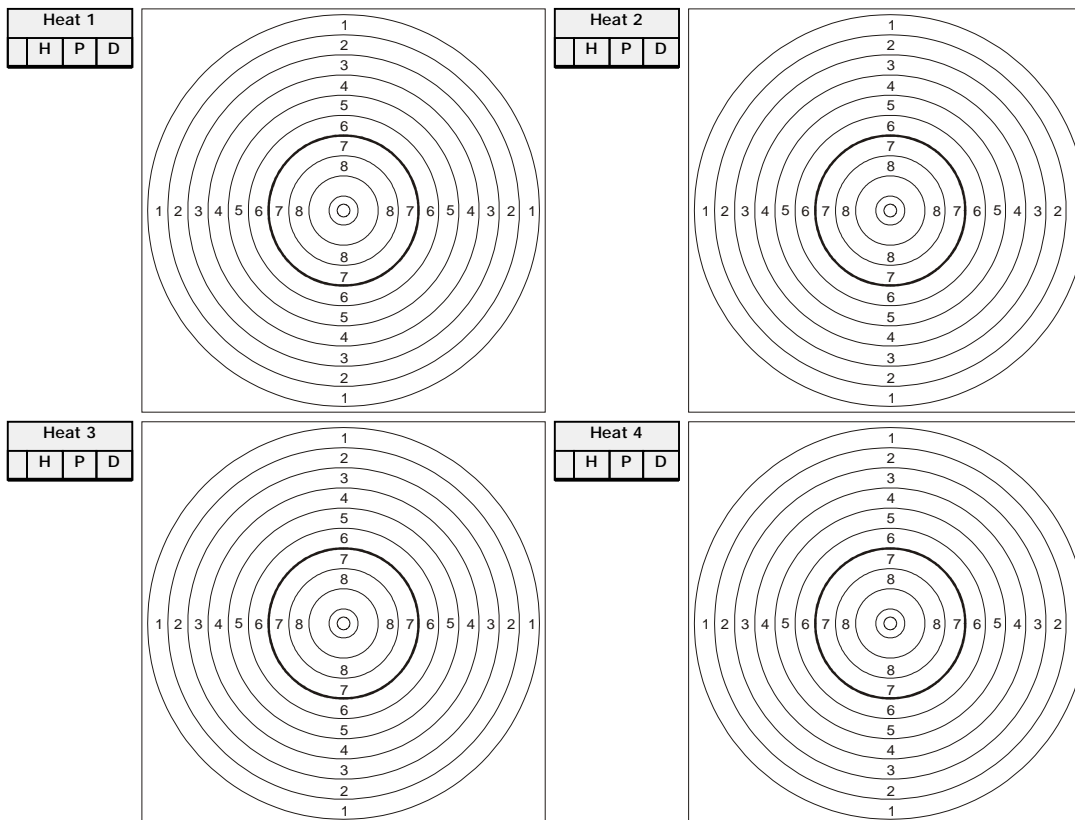

INDIVIDUAL SHOOTING RESULTS

WORLD CUP SOFIA2023 - WOMEN'S QUALIFICATION "A"

0

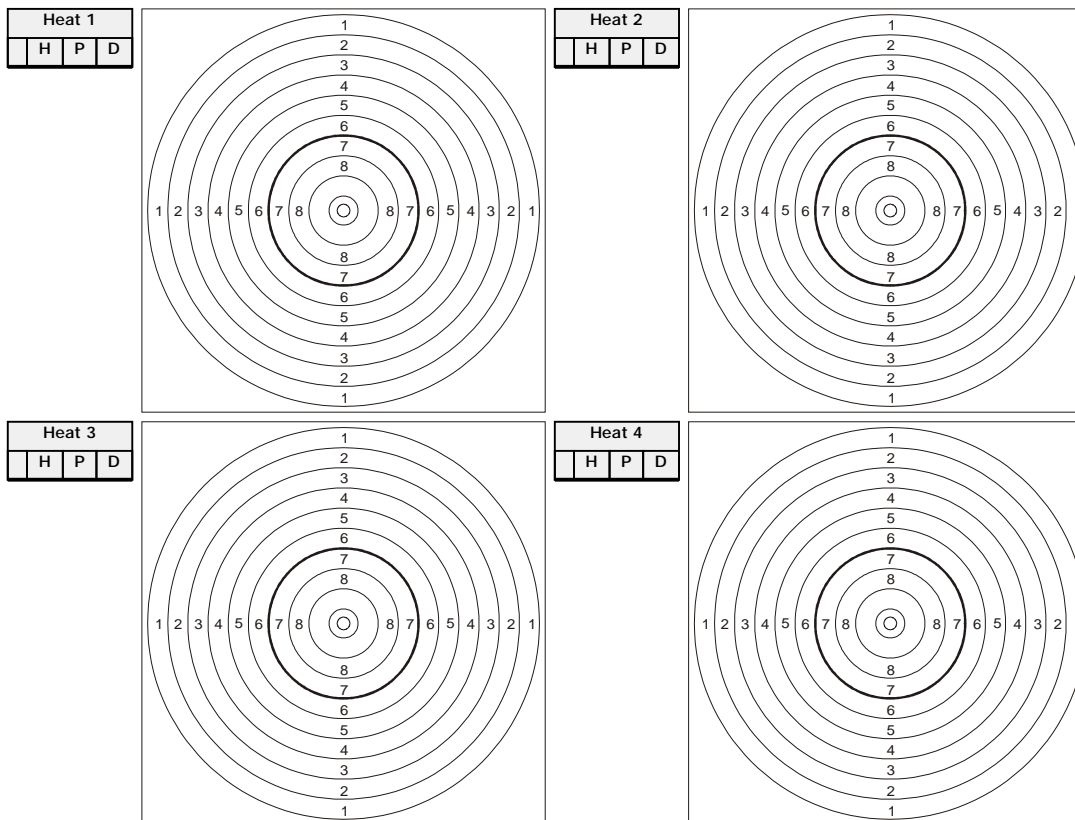

INDIVIDUAL SHOOTING RESULTS

WORLD CUP SOFIA2023 - WOMEN'S QUALIFICATION "A"

0

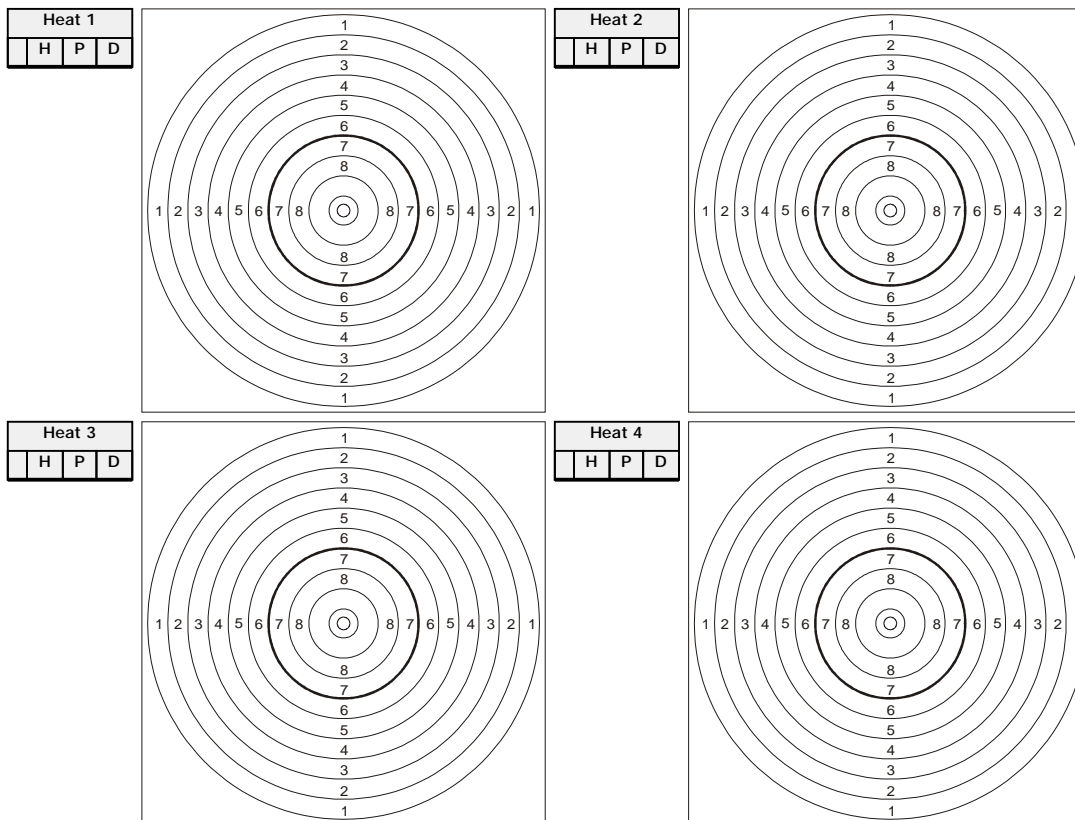

INDIVIDUAL SHOOTING RESULTS

WORLD CUP SOFIA2023 - WOMEN'S QUALIFICATION "A"

0

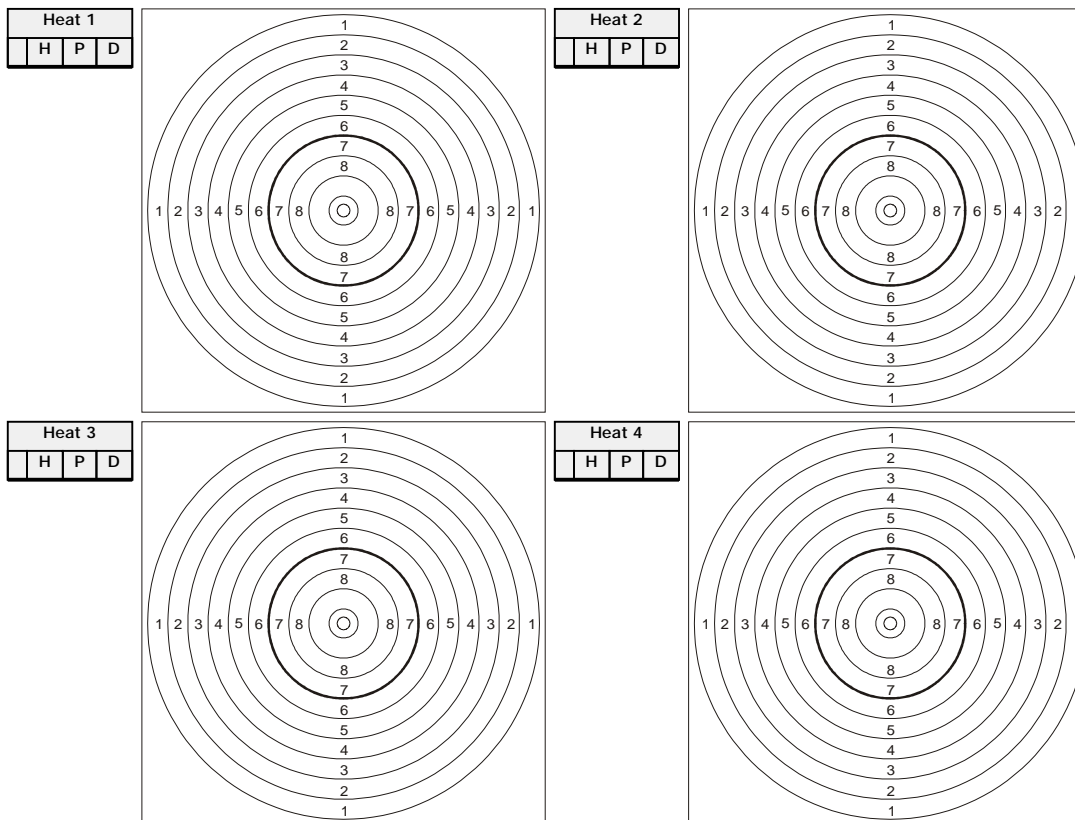

INDIVIDUAL SHOOTING RESULTS

WORLD CUP SOFIA2023 - WOMEN'S QUALIFICATION "A"

0

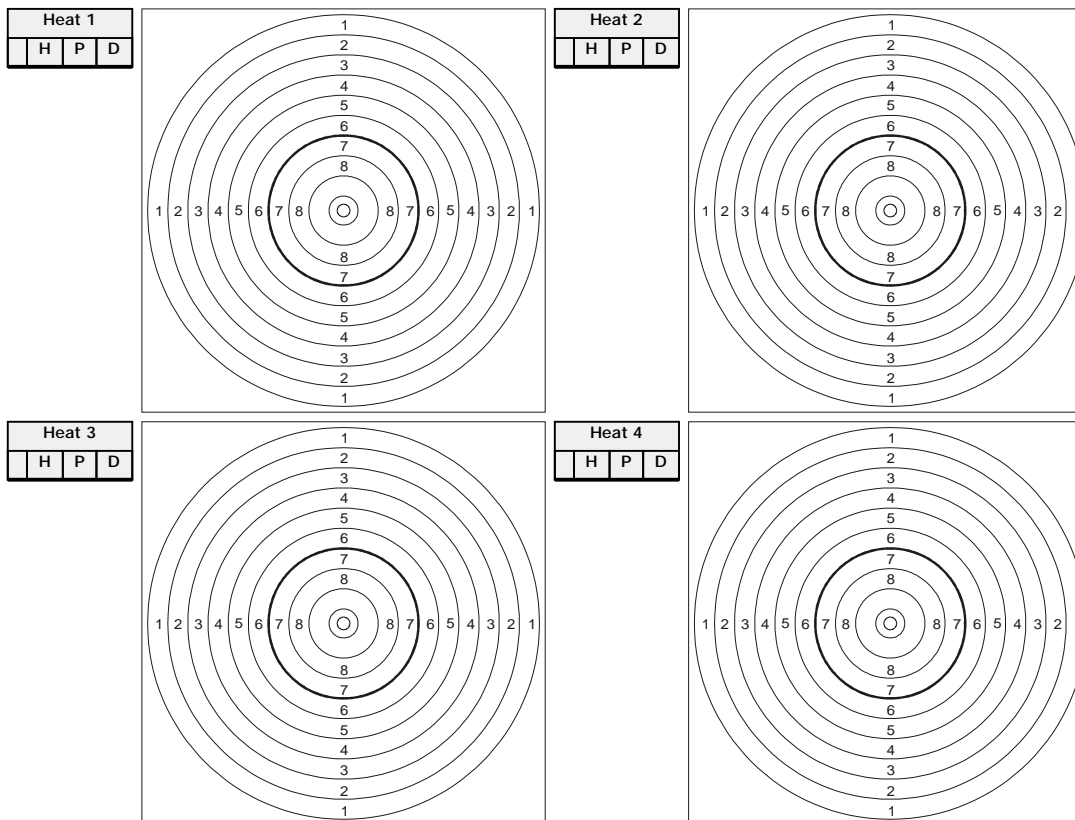

INDIVIDUAL SHOOTING RESULTS

WORLD CUP SOFIA2023 - WOMEN'S QUALIFICATION "A"

0

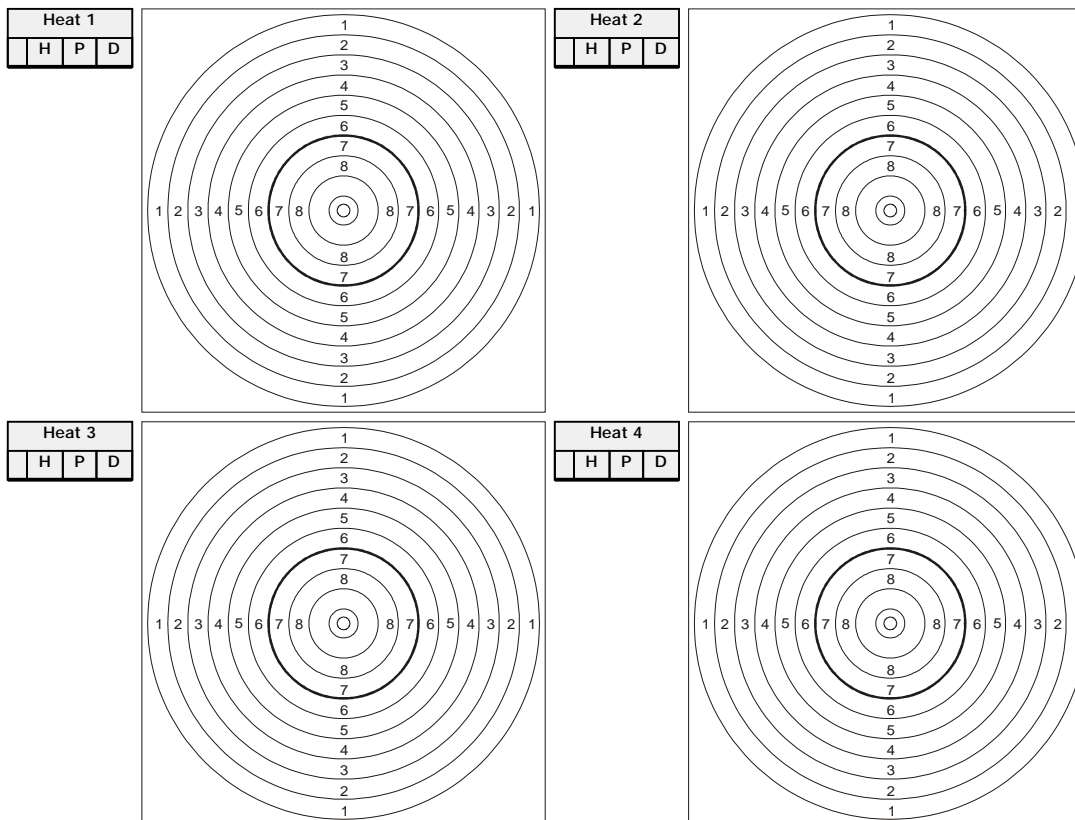

INDIVIDUAL SHOOTING RESULTS

WORLD CUP SOFIA2023 - WOMEN'S QUALIFICATION "A"

0

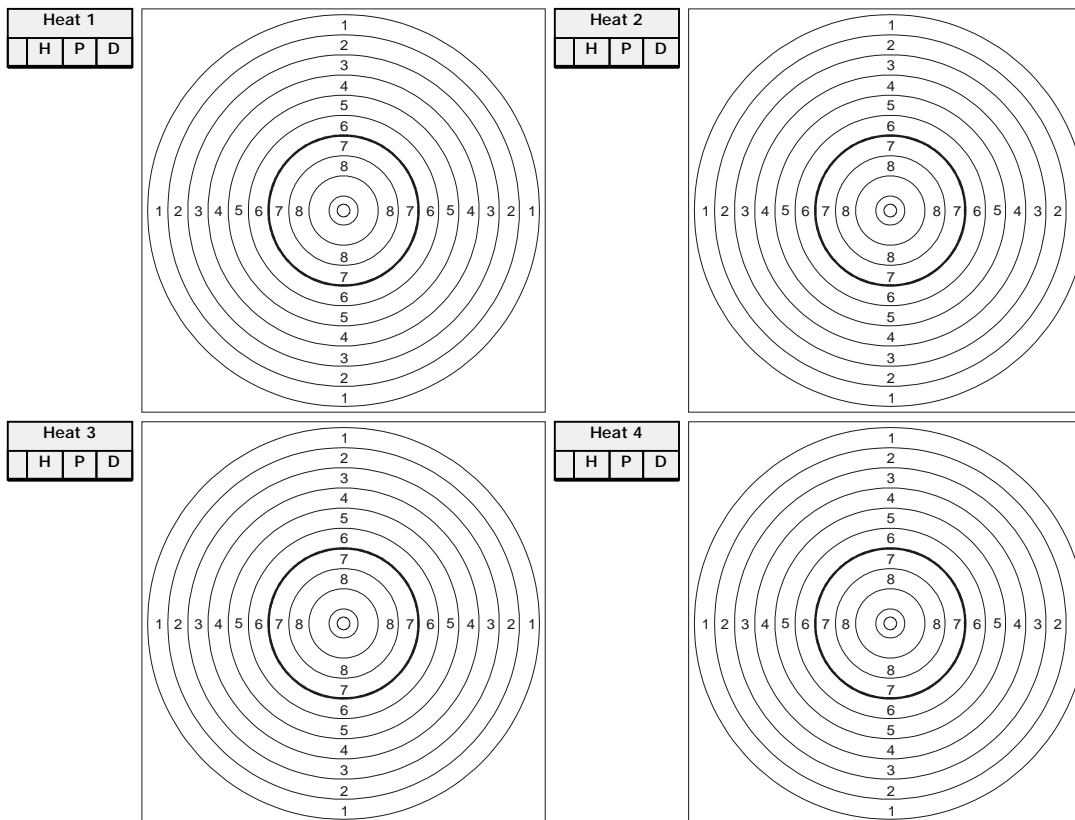

INDIVIDUAL SHOOTING RESULTS

WORLD CUP SOFIA2023 - WOMEN'S QUALIFICATION "A"

0

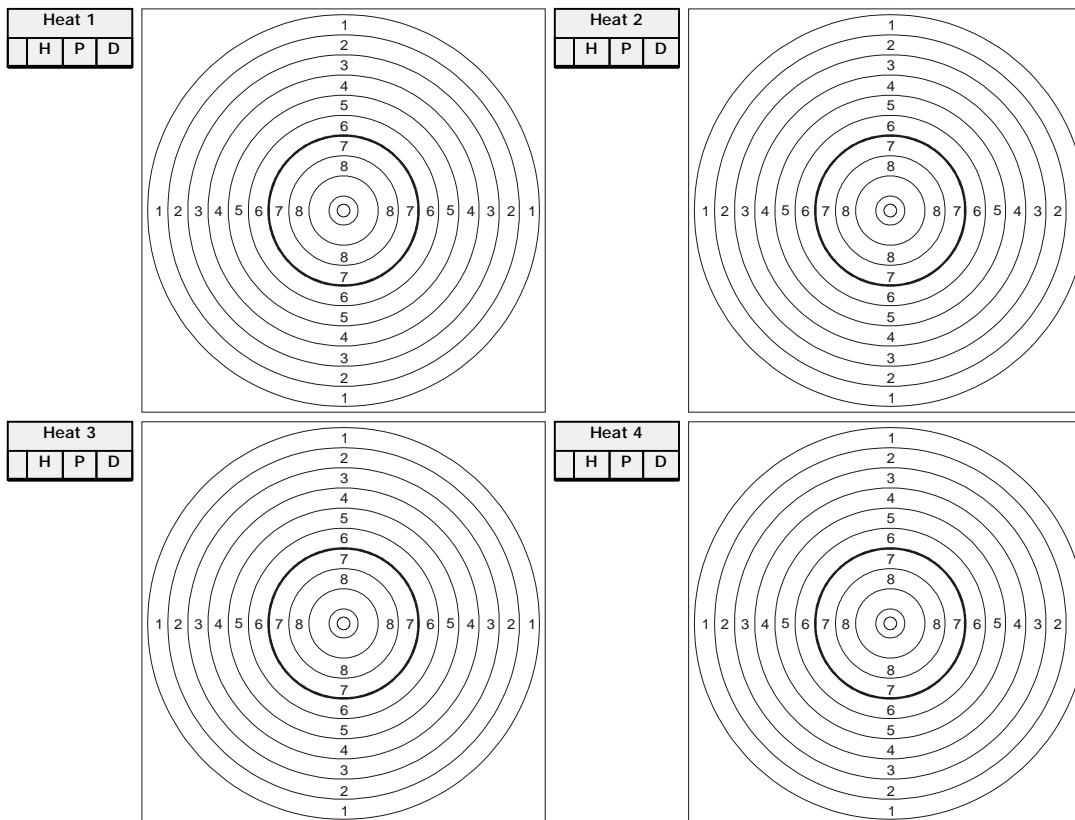

INDIVIDUAL SHOOTING RESULTS

WORLD CUP SOFIA2023 - WOMEN'S QUALIFICATION "A"

0

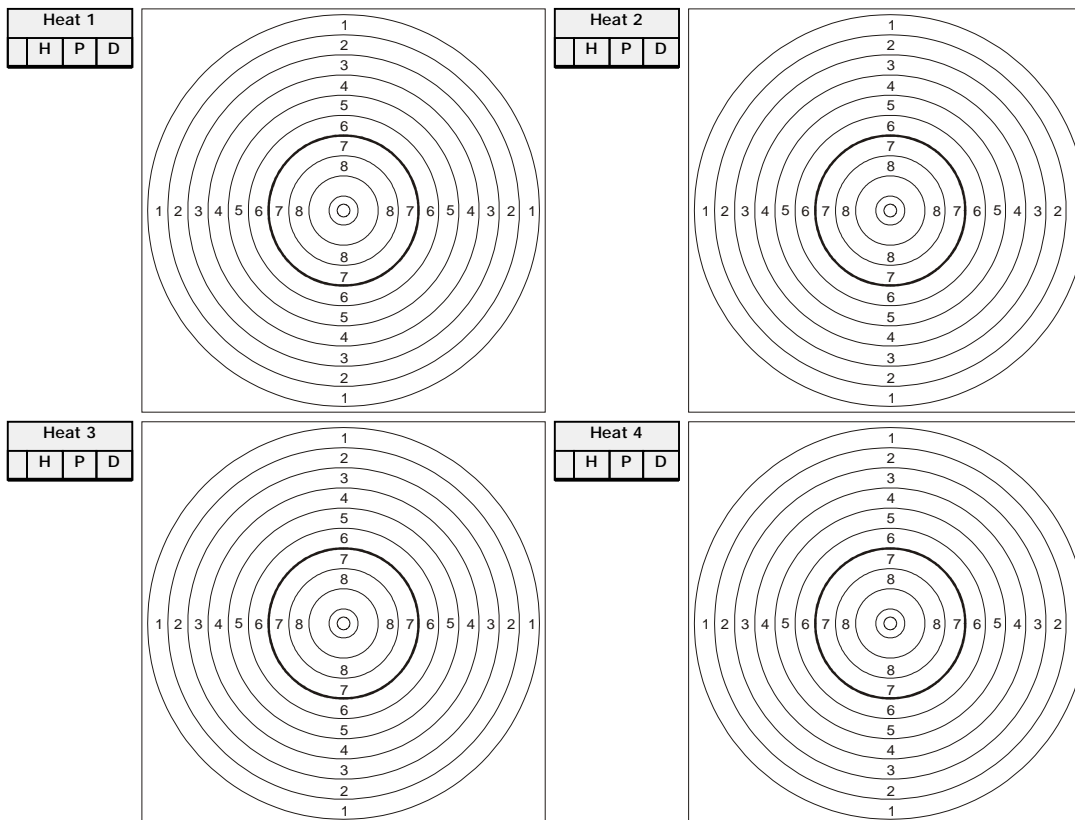

INDIVIDUAL SHOOTING RESULTS

WORLD CUP SOFIA2023 - WOMEN'S QUALIFICATION "A"

0

