

INDIVIDUAL SHOOTING RESULTS

WORLD CUP SOFIA, BULGARIA 2023 - MEN'S QUALIFICATION "A"

Joseph CHOONG (GBR)

Heat 1			
	H	P	D
Tot	5/1/6	8,0	10,82
1	O	9,4	-
2	O	8,3	2,03
3	O	7,8	2,12
4	-	4,7	2,22
5	O	9,3	1,92
6	O	8,5	2,53

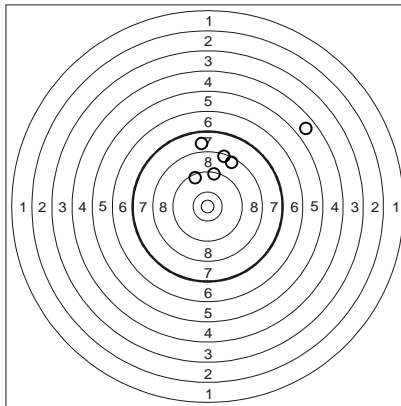

Heat 2			
	H	P	D
Tot	5/1/6	8,2	10,02
1	O	8,1	-
2	-	5,7	1,91
3	O	8,8	1,87
4	O	8,3	1,87
5	O	8,9	2,12
6	O	9,2	2,25

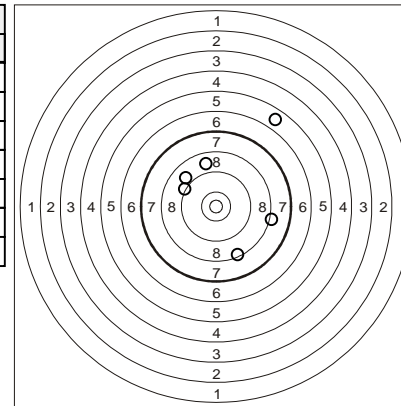

Heat 3			
	H	P	D
Tot	5/1/6	9,0	10,30
1	-	6,5	-
2	O	10,1	2,02
3	O	10,2	1,89
4	O	9,4	2,04
5	O	8,3	2,13
6	O	9,3	2,22

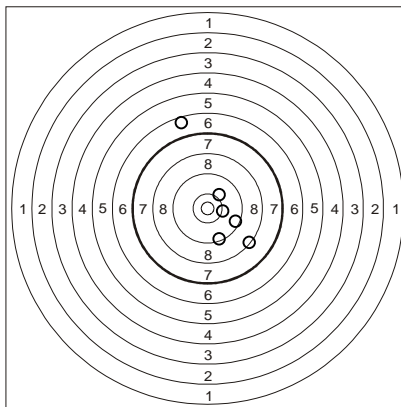

Heat 4			
	H	P	D
Tot	5/1/6	8,4	9,66
1	O	7,6	-
2	O	8,9	1,85
3	O	10,1	1,89
4	O	9,0	1,77
5	-	5,9	1,90
6	O	8,6	2,25

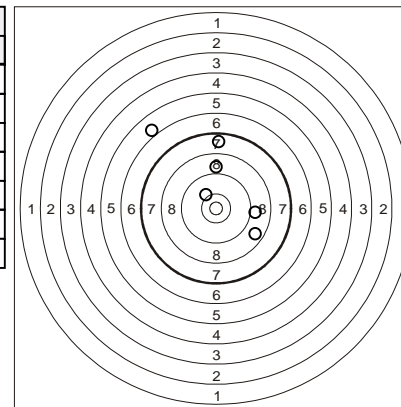

INDIVIDUAL SHOOTING RESULTS

WORLD CUP SOFIA, BULGARIA 2023 - MEN'S QUALIFICATION "A"

Eslam HAMAD (EGY)

Heat 1			
	H	P	D
Tot	5/0/5	8,8	7,78
1	O	9,6	-
2	O	8,0	1,93
3	O	10,2	2,02
4	O	7,4	1,98
5	O	9,0	1,85

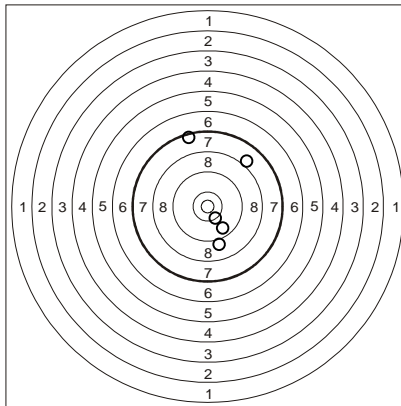

Heat 2			
	H	P	D
Tot	5/2/7	7,3	11,27
1	O	9,5	-
2	O	7,6	2,02
3	O	7,7	1,62
4	O	8,8	1,99
5	-	5,8	1,73
6	-	2,3	2,00
7	O	9,6	1,91

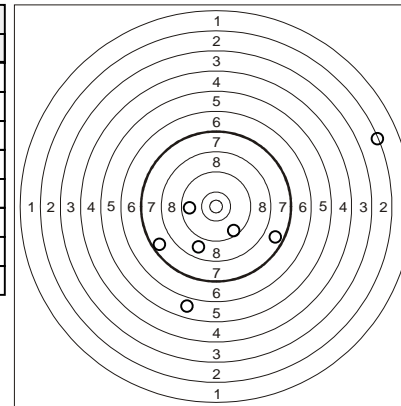

Heat 3			
	H	P	D
Tot	5/1/6	8,1	9,60
1	O	7,6	-
2	O	10,0	1,99
3	-	5,7	1,74
4	O	7,3	2,01
5	O	9,3	1,80
6	O	8,5	2,06

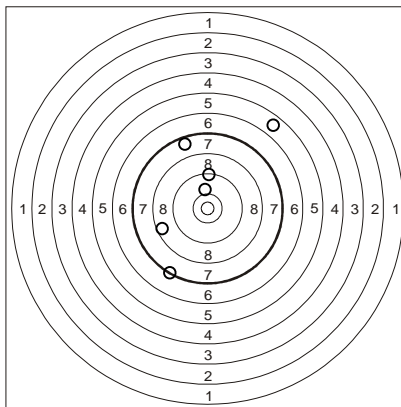

Heat 4			
	H	P	D
Tot	5/2/7	7,9	11,83
1	O	9,7	-
2	O	7,9	2,04
3	O	7,6	1,90
4	O	8,6	1,94
5	-	5,1	1,81
6	-	6,5	2,16
7	O	9,6	1,98

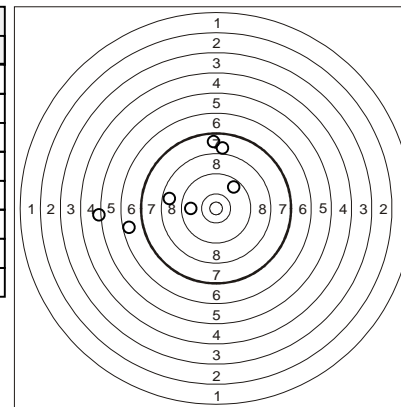

INDIVIDUAL SHOOTING RESULTS

WORLD CUP SOFIA, BULGARIA 2023 - MEN'S QUALIFICATION "A"

Jihun LEE (KOR)

Heat 1			
	H	P	D
Tot	5/1/6	8,3	10,14
1	O	8,2	-
2	O	9,0	2,12
3	O	8,8	1,94
4	-	5,3	2,29
5	O	10,1	1,93
6	O	8,5	1,86

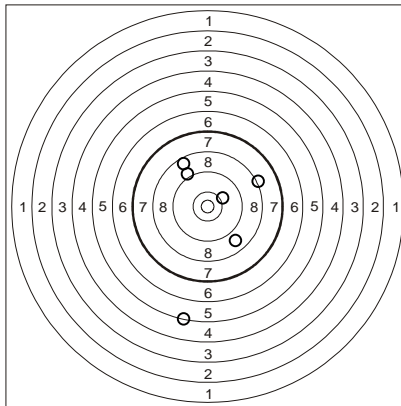

Heat 2			
	H	P	D
Tot	5/1/6	8,2	9,60
1	O	8,7	-
2	O	9,6	1,89
3	O	7,4	1,96
4	-	5,6	1,92
5	O	7,8	1,82
6	O	10,0	2,01

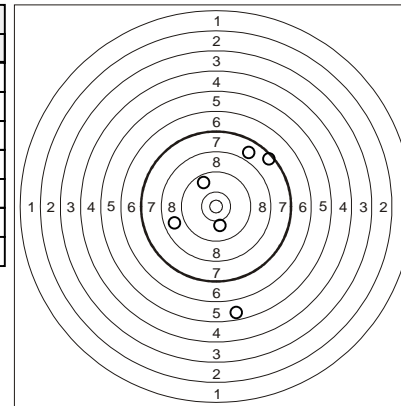

Heat 3			
	H	P	D
Tot	5/1/6	9,3	9,32
1	O	9,2	-
2	O	9,9	2,05
3	O	10,6	1,80
4	O	9,3	1,82
5	-	7,0	1,83
6	O	10,0	1,82

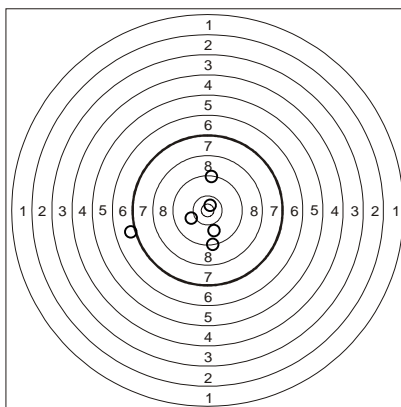

Heat 4			
	H	P	D
Tot	5/0/5	8,0	7,43
1	O	7,4	-
2	O	9,5	1,88
3	O	7,4	1,87
4	O	8,3	1,81
5	O	7,4	1,87

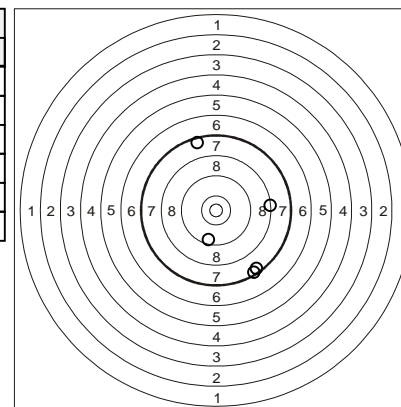

INDIVIDUAL SHOOTING RESULTS

WORLD CUP SOFIA, BULGARIA 2023 - MEN'S QUALIFICATION "A"

Jozsef TAMAS (HUN)

Heat 1			
	H	P	D
Tot	5/5/10	7,0	16,51
1	O	7,9	-
2	-	6,0	2,34
3	O	9,6	1,64
4	O	8,9	1,69
5	O	10,0	1,62
6	-	5,0	1,71
7	-	6,5	1,83
8	-	5,0	2,00
9	-	3,2	1,83
10	O	7,7	1,85

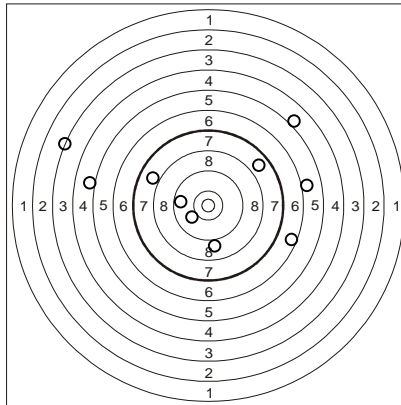

Heat 2			
	H	P	D
Tot	5/3/8	6,8	11,72
1	O	8,2	-
2	-	5,2	1,78
3	O	7,6	1,54
4	-	2,3	1,63
5	O	9,4	1,63
6	-	4,1	1,71
7	O	9,4	1,69
8	O	8,1	1,74

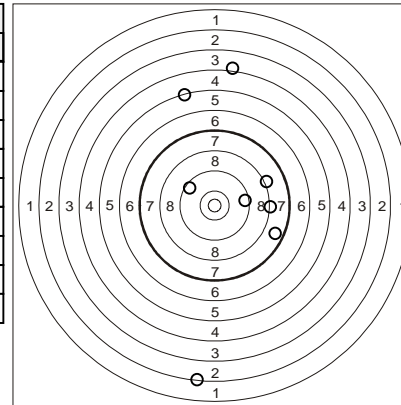

Heat 3			
	H	P	D
Tot	5/10/15	5,9	24,19
1	-	4,0	-
2	-	6,6	1,73
3	O	7,4	1,60
4	-	3,4	1,62
5	-	5,2	1,62
6	O	8,5	1,61
7	-	4,1	1,63
8	O	9,2	1,63
9	-	7,1	1,73
10	-	3,4	1,82
11	O	8,7	1,83
12	-	6,0	1,71
13	-	5,9	1,99
14	-	0,0	1,84
15	O	8,7	1,83

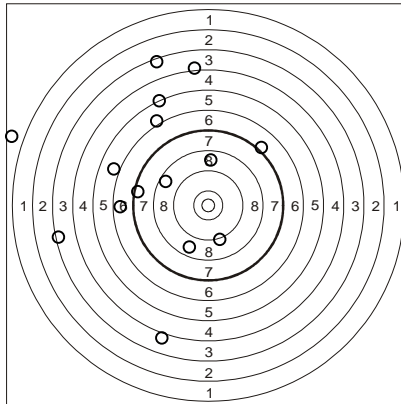

Heat 4			
	H	P	D
Tot	5/12/17	6,4	31,62
1	-	4,9	-
2	O	7,6	2,72
3	O	7,7	1,73
4	-	3,4	1,70
5	-	4,7	1,63
6	-	6,1	1,74
7	O	8,8	1,91
8	-	6,4	1,74
9	-	5,3	2,03
10	O	10,3	1,92
11	-	6,4	1,94
12	-	4,7	2,01
13	-	7,2	2,09
14	-	5,0	2,19
15	-	5,9	2,00
16	-	6,1	2,04
17	O	7,6	2,23

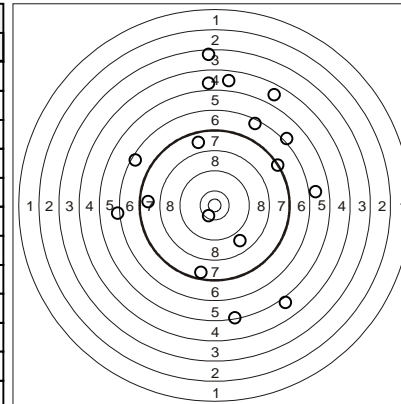

INDIVIDUAL SHOOTING RESULTS

WORLD CUP SOFIA, BULGARIA 2023 - MEN'S QUALIFICATION "A"

Fernand MITTERRAND (GER)

Heat 1			
	H	P	D
Tot	5/4/9	7,0	19,19
1	-	4,8	-
2	O	7,8	2,59
3	O	8,7	2,22
4	-	5,4	2,22
5	O	8,6	2,18
6	-	3,2	2,34
7	O	9,4	2,44
8	-	6,8	2,62
9	O	8,1	2,58

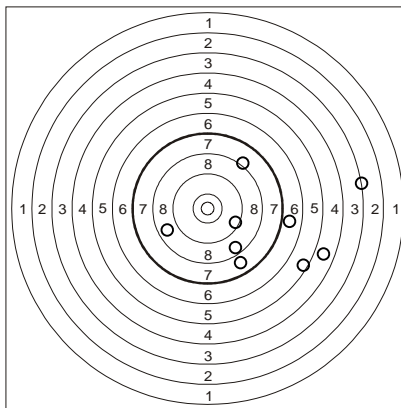

Heat 2			
	H	P	D
Tot	5/1/6	8,3	10,62
1	O	7,7	-
2	O	8,1	2,41
3	O	8,4	2,04
4	-	6,8	1,97
5	O	9,1	2,06
6	O	9,4	2,14

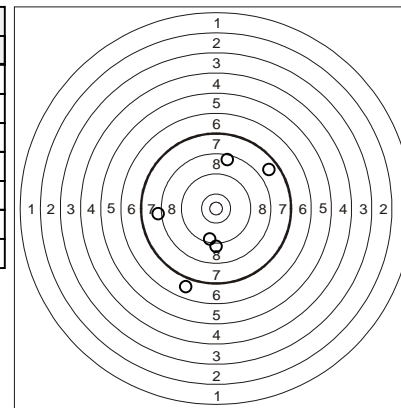

Heat 3			
	H	P	D
Tot	5/2/7	7,9	13,21
1	-	6,4	-
2	O	8,3	2,44
3	O	9,8	2,36
4	O	9,5	2,11
5	O	8,6	2,04
6	-	4,1	2,09
7	O	8,5	2,17

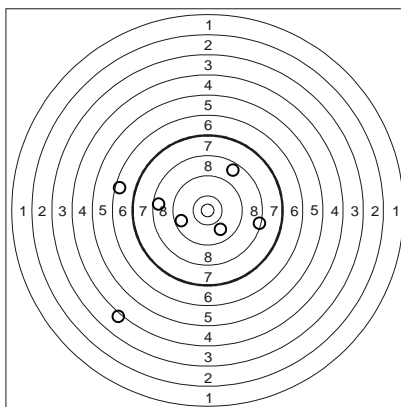

Heat 4			
	H	P	D
Tot	5/5/10	7,4	21,73
1	-	6,9	-
2	O	8,6	2,34
3	-	5,1	2,43
4	O	9,1	2,28
5	-	6,5	2,25
6	-	6,0	2,59
7	-	6,5	2,61
8	O	8,2	2,39
9	O	8,6	2,29
10	O	8,0	2,55

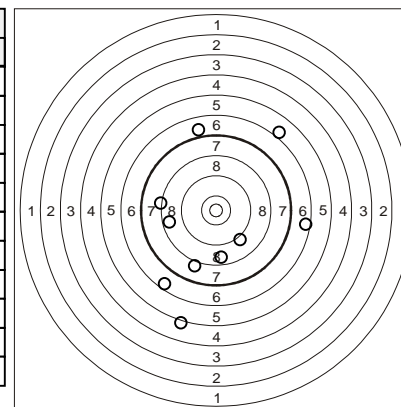

INDIVIDUAL SHOOTING RESULTS

WORLD CUP SOFIA, BULGARIA 2023 - MEN'S QUALIFICATION "A"

Ondrej SVECHOTA (CZE)

Heat 1			
	H	P	D
Tot	5/0/5	8,9	8,90
1	O	8,9	-
2	O	9,0	2,16
3	O	8,4	2,18
4	O	8,9	2,22
5	O	9,4	2,34

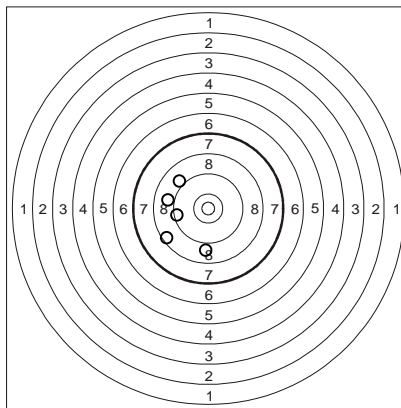

Heat 2			
	H	P	D
Tot	5/4/9	7,0	18,11
1	O	8,9	-
2	-	5,3	2,37
3	O	7,8	2,09
4	-	3,5	2,25
5	O	7,4	2,11
6	-	6,3	2,24
7	O	8,2	2,21
8	-	6,3	2,26
9	O	9,4	2,58

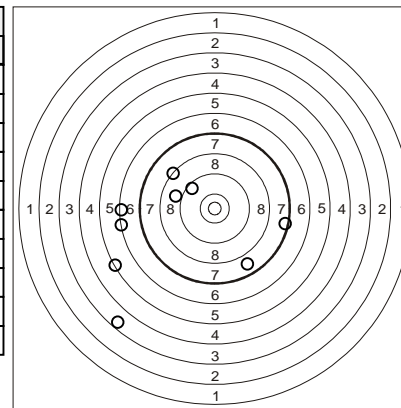

Heat 3			
	H	P	D
Tot	5/1/6	8,6	11,42
1	O	9,8	-
2	O	9,9	2,16
3	-	7,2	2,02
4	O	7,5	2,23
5	O	8,6	2,61
6	O	8,7	2,40

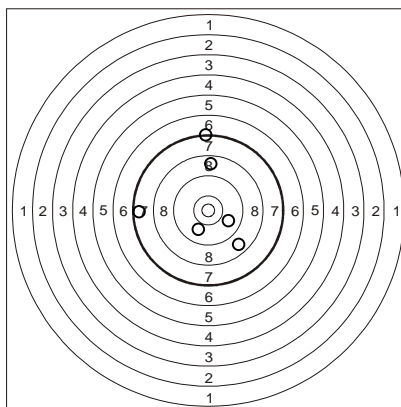

Heat 4			
	H	P	D
Tot	5/3/8	7,5	16,06
1	O	7,9	-
2	O	8,8	2,18
3	-	6,3	2,23
4	O	9,3	2,43
5	O	8,4	2,25
6	-	5,1	2,18
7	-	4,8	2,28
8	O	9,4	2,51

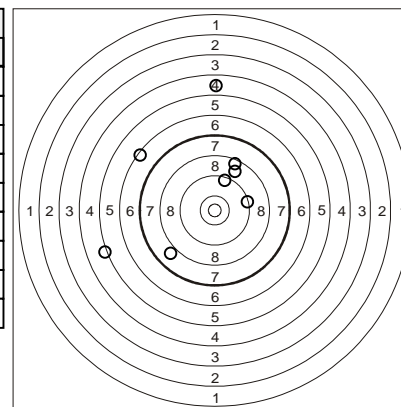

INDIVIDUAL SHOOTING RESULTS

WORLD CUP SOFIA, BULGARIA 2023 - MEN'S QUALIFICATION "A"

Shuai LUO (CHN)

Heat 1			
	H	P	D
Tot	5/5/10	7,8	18,65
1	-	6,3	-
2	O	8,7	2,37
3	O	9,8	1,91
4	-	6,7	1,93
5	-	6,4	1,92
6	O	9,9	1,93
7	-	7,2	2,65
8	O	9,7	2,01
9	-	5,1	2,02
10	O	8,1	1,91

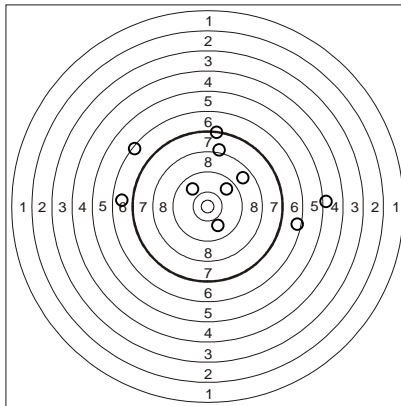

Heat 2			
	H	P	D
Tot	5/4/9	7,4	15,55
1	O	9,8	-
2	-	6,7	2,02
3	O	8,0	1,96
4	O	7,3	1,86
5	-	5,6	1,91
6	-	6,5	1,93
7	-	5,9	1,90
8	O	7,4	1,93
9	O	9,6	2,04

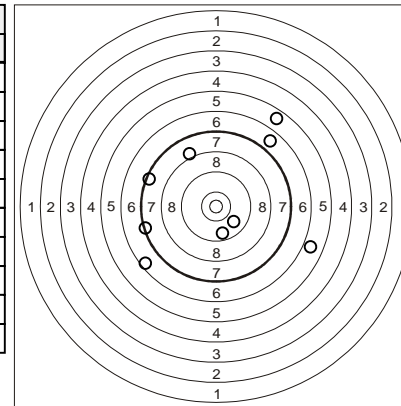

Heat 3			
	H	P	D
Tot	5/0/5	8,2	7,42
1	O	8,6	-
2	O	8,0	1,89
3	O	8,1	1,87
4	O	9,0	1,82
5	O	7,3	1,84

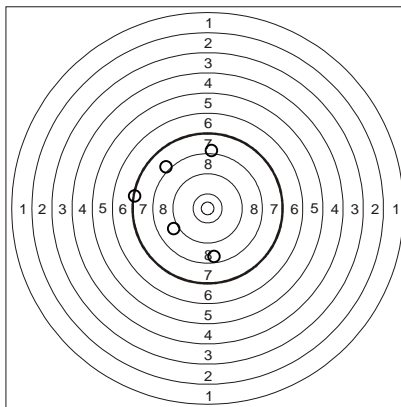

Heat 4			
	H	P	D
Tot	5/0/5	8,7	8,37
1	O	8,6	-
2	O	8,3	2,01
3	O	9,8	1,83
4	O	8,2	2,71
5	O	8,6	1,82

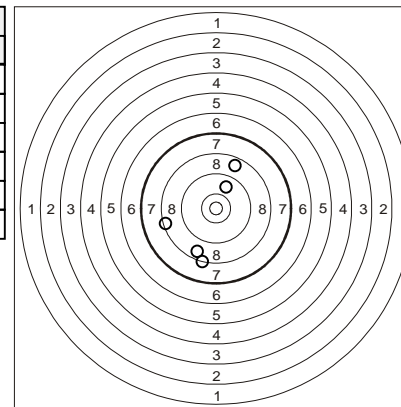

INDIVIDUAL SHOOTING RESULTS

WORLD CUP SOFIA, BULGARIA 2023 - MEN'S QUALIFICATION "A"

Lorenzo MACIAS (MEX)

Heat 1			
	H	P	D
Tot	5/2/7	8,6	11,28
1	-	7,2	-
2	O	9,3	1,94
3	O	10,4	1,97
4	O	9,4	1,88
5	O	10,1	1,84
6	-	6,6	1,72
7	O	7,4	1,93

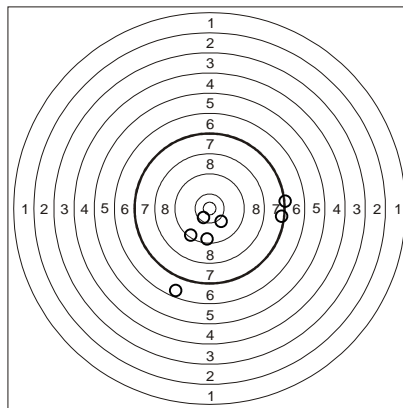

Heat 2			
	H	P	D
Tot	5/3/8	7,3	13,02
1	-	4,4	-
2	-	5,8	1,78
3	O	10,0	2,08
4	O	7,8	1,85
5	-	5,3	2,06
6	O	10,3	1,56
7	O	7,5	1,74
8	O	7,6	1,95

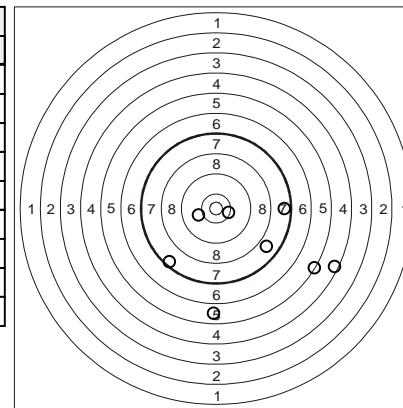

Heat 3			
	H	P	D
Tot	5/3/8	7,5	12,67
1	-	6,3	-
2	O	8,9	1,83
3	-	7,1	1,93
4	O	7,7	1,65
5	-	6,2	1,91
6	O	7,4	1,69
7	O	7,3	1,81
8	O	9,4	1,85

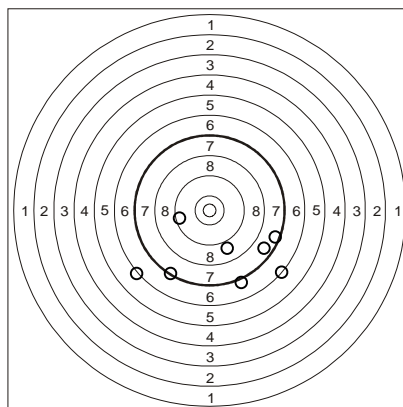

Heat 4			
	H	P	D
Tot	5/4/9	7,2	14,03
1	-	7,0	-
2	O	7,4	1,82
3	-	3,9	1,81
4	O	9,9	1,79
5	-	6,8	1,85
6	-	4,5	1,71
7	O	7,9	1,72
8	O	9,9	1,64
9	O	7,5	1,69

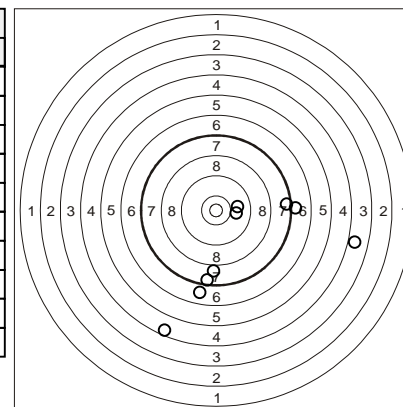

INDIVIDUAL SHOOTING RESULTS

WORLD CUP SOFIA, BULGARIA 2023 - MEN'S QUALIFICATION "A"

Richard BERECZKI (HUN)

Heat 1			
	H	P	D
Tot	5/6/11	6,8	17,93
1	O	8,3	-
2	O	9,6	2,03
3	O	7,9	1,79
4	-	3,9	1,61
5	-	6,2	1,72
6	-	4,3	1,74
7	O	7,5	1,62
8	-	4,0	1,74
9	-	7,1	1,68
10	-	6,4	2,09
11	O	9,7	1,91

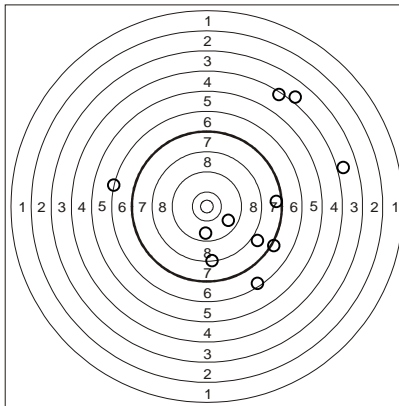

Heat 2			
	H	P	D
Tot	5/4/9	7,3	13,24
1	O	8,2	-
2	O	8,0	1,84
3	-	4,5	1,63
4	-	4,8	1,58
5	-	6,7	1,62
6	-	5,7	1,63
7	O	10,3	1,69
8	O	9,0	1,63
9	O	8,4	1,62

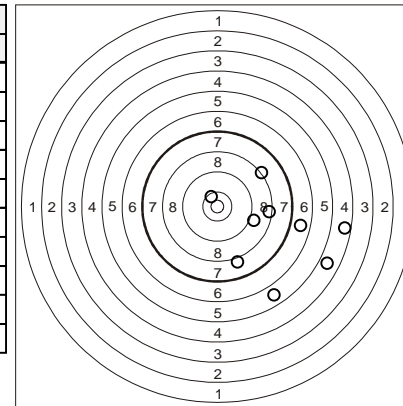

Heat 3			
	H	P	D
Tot	5/4/9	7,0	13,46
1	-	3,0	-
2	O	9,2	1,81
3	O	8,2	1,64
4	-	6,3	1,63
5	O	7,7	1,69
6	O	10,3	1,70
7	-	5,1	1,50
8	-	6,0	1,66
9	O	7,6	1,83

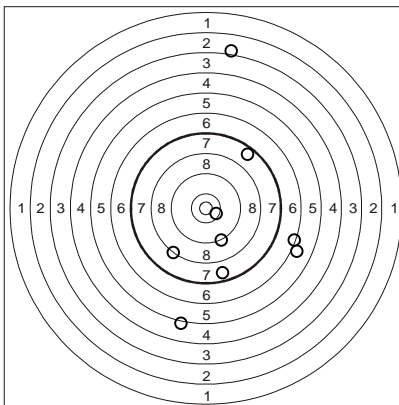

Heat 4			
	H	P	D
Tot	5/9/14	6,6	22,44
1	-	3,1	-
2	O	7,9	1,89
3	-	3,0	1,75
4	-	6,4	1,57
5	O	9,4	1,64
6	-	5,2	1,63
7	O	8,1	1,68
8	-	6,2	1,65
9	-	6,5	1,63
10	-	6,9	1,83
11	-	6,5	1,78
12	-	7,1	1,74
13	O	9,0	1,91
14	O	7,4	1,74

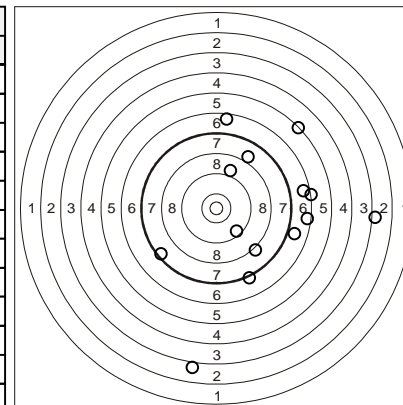

INDIVIDUAL SHOOTING RESULTS

WORLD CUP SOFIA, BULGARIA 2023 - MEN'S QUALIFICATION "A"

Gaga KHIJAKADZE (GEO)

Heat 1			
	H	P	D
Tot	5/9/14	7,0	22,03
1	-	4,5	-
2	-	5,3	1,96
3	-	6,7	1,86
4	-	5,3	1,81
5	-	7,2	1,64
6	O	8,1	1,61
7	-	6,6	1,64
8	-	5,2	1,59
9	O	7,6	1,64
10	-	7,1	1,66
11	-	6,9	1,67
12	O	8,5	1,72
13	O	9,3	1,53
14	O	9,6	1,70

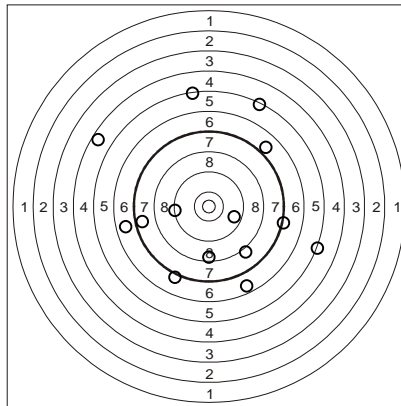

Heat 2			
	H	P	D
Tot	5/3/8	7,6	12,09
1	O	8,0	-
2	-	6,3	1,99
3	O	8,6	1,72
4	-	6,7	1,76
5	O	8,2	1,59
6	O	7,4	1,61
7	-	6,7	1,62
8	O	8,6	1,80

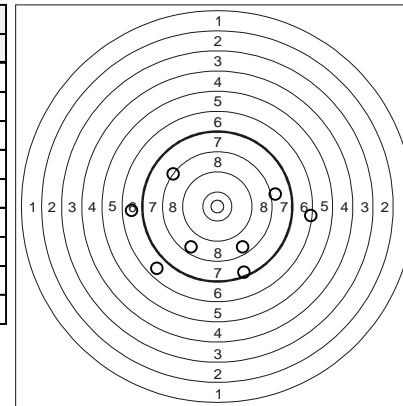

Heat 3			
	H	P	D
Tot	5/4/9	7,2	13,42
1	-	5,4	-
2	-	5,2	1,82
3	O	10,1	1,63
4	O	8,0	1,61
5	-	6,7	1,65
6	O	9,3	1,65
7	-	4,4	1,67
8	O	7,7	1,71
9	O	7,6	1,68

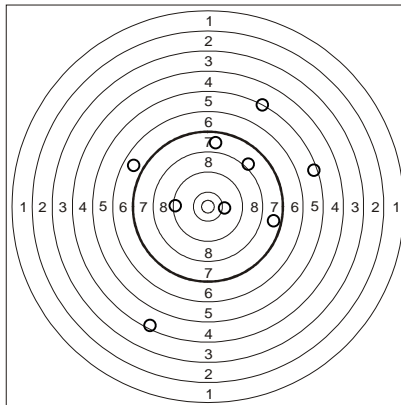

Heat 4			
	H	P	D
Tot	5/1/6	8,7	8,99
1	O	8,9	-
2	-	7,2	1,98
3	O	9,2	1,76
4	O	9,2	1,69
5	O	9,4	1,70
6	O	8,1	1,86

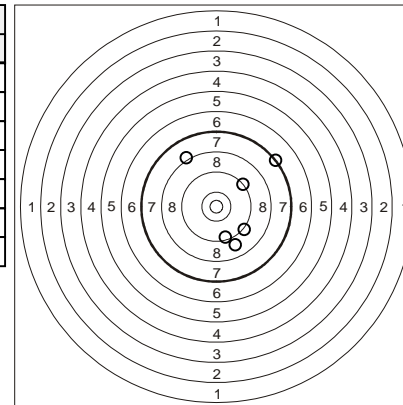

INDIVIDUAL SHOOTING RESULTS

WORLD CUP SOFIA, BULGARIA 2023 - MEN'S QUALIFICATION "A"

Stefano FREZZA (ITA)

Heat 1			
	H	P	D
Tot	5/3/8	7,7	14,18
1	O	7,3	-
2	O	9,1	1,97
3	-	4,2	1,95
4	-	7,2	2,01
5	O	8,7	1,93
6	O	8,9	1,93
7	-	7,2	2,03
8	O	9,3	2,36

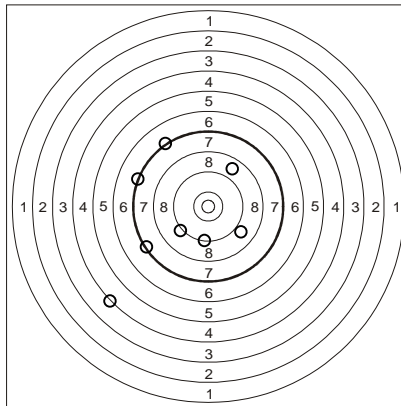

Heat 2			
	H	P	D
Tot	5/0/5	8,2	7,80
1	O	7,4	-
2	O	9,0	2,02
3	O	7,8	1,94
4	O	7,7	1,97
5	O	9,3	1,87

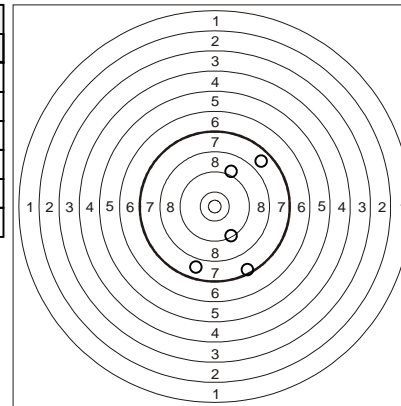

Heat 3			
	H	P	D
Tot	5/1/6	7,7	9,63
1	O	8,2	-
2	O	7,4	1,91
3	O	8,4	1,93
4	-	6,2	1,89
5	O	7,5	2,01
6	O	8,2	1,89

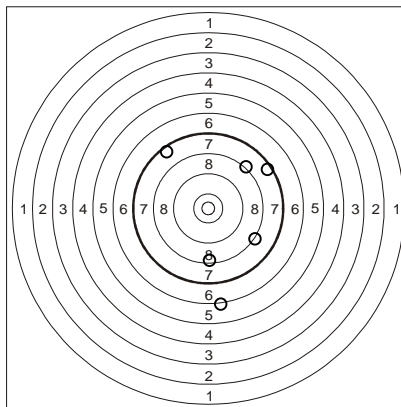

Heat 4			
	H	P	D
Tot	5/1/6	8,6	9,59
1	O	9,7	-
2	O	8,6	2,05
3	-	6,8	1,88
4	O	7,6	1,79
5	O	9,5	1,79
6	O	9,2	2,08

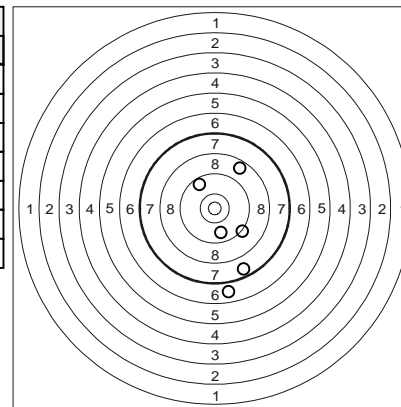

INDIVIDUAL SHOOTING RESULTS

WORLD CUP SOFIA, BULGARIA 2023 - MEN'S QUALIFICATION "A"

Daniel STEINBOCK (SWE)

Heat 1			
	H	P	D
Tot	5/4/9	7,0	16,48
1	-	6,1	-
2	O	7,9	2,85
3	O	7,7	1,99
4	O	8,0	1,84
5	-	5,3	1,92
6	O	8,1	1,89
7	-	5,4	1,93
8	-	5,9	1,96
9	O	8,6	2,10

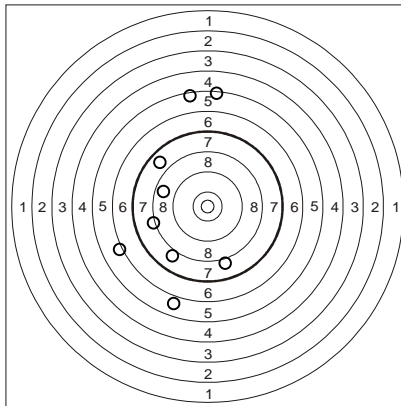

Heat 2			
	H	P	D
Tot	5/3/8	7,3	13,95
1	-	6,2	-
2	O	7,6	2,11
3	-	7,0	2,04
4	O	9,0	2,01
5	-	3,0	1,92
6	O	8,3	1,92
7	O	7,3	1,81
8	O	10,3	2,14

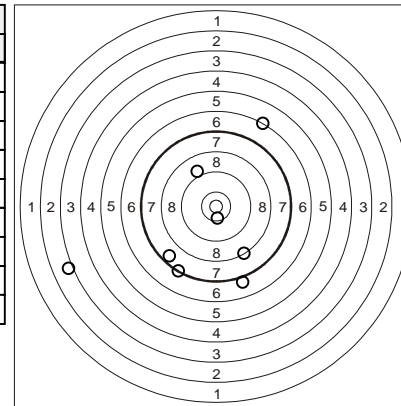

Heat 3			
	H	P	D
Tot	5/4/9	7,8	16,17
1	-	4,7	-
2	-	6,5	2,19
3	O	7,9	2,00
4	-	5,1	2,06
5	O	10,2	2,09
6	O	9,9	1,93
7	-	7,1	1,86
8	O	9,4	2,02
9	O	9,3	2,02

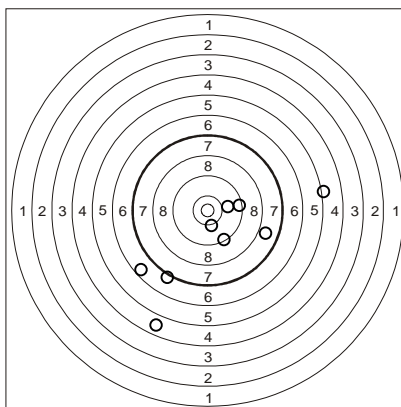

Heat 4			
	H	P	D
Tot	5/2/7	7,6	11,65
1	-	4,7	-
2	O	8,6	1,91
3	O	8,9	1,95
4	O	8,8	2,00
5	O	7,3	1,93
6	-	7,1	1,82
7	O	8,0	2,04

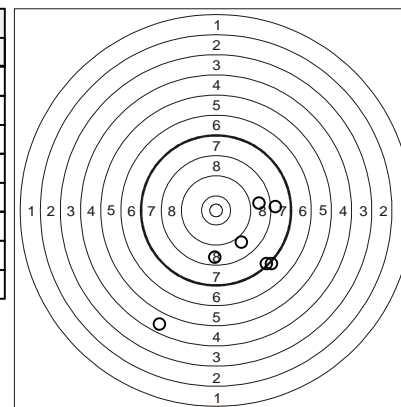

INDIVIDUAL SHOOTING RESULTS

WORLD CUP SOFIA, BULGARIA 2023 - MEN'S QUALIFICATION "A"

Tristen BELL (USA)

Heat 1			
	H	P	D
Tot	5/9/14	6,7	24,02
1	-	2,4	-
2	-	6,7	1,88
3	-	5,2	1,80
4	O	8,6	1,92
5	-	7,1	1,82
6	-	6,5	1,88
7	O	10,2	1,84
8	-	4,8	1,75
9	-	5,8	1,83
10	-	5,2	1,93
11	O	7,6	1,86
12	-	4,9	1,71
13	O	10,7	1,94
14	O	8,0	1,86

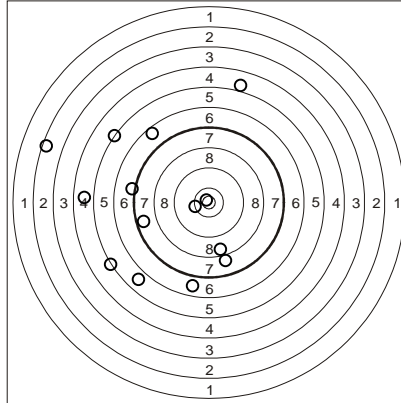

Heat 2			
	H	P	D
Tot	5/0/5	9,6	7,12
1	O	8,8	-
2	O	10,0	1,89
3	O	10,1	1,70
4	O	9,5	1,75
5	O	9,5	1,78

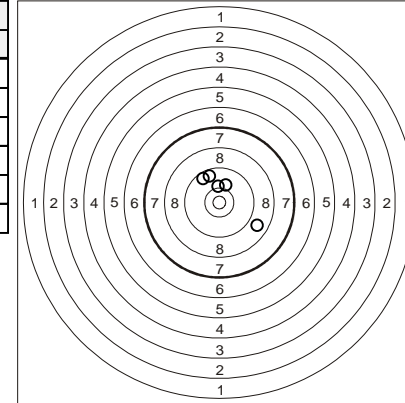

Heat 3			
	H	P	D
Tot	5/2/7	7,9	10,98
1	O	8,3	-
2	O	8,2	1,89
3	O	9,9	1,75
4	-	4,2	1,79
5	-	6,0	1,94
6	O	8,7	1,80
7	O	10,1	1,81

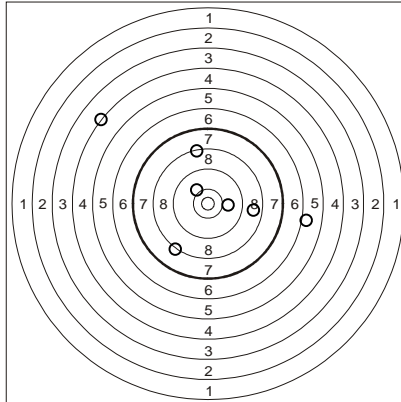

Heat 4			
	H	P	D
Tot	5/7/12	7,2	21,13
1	-	6,9	-
2	-	7,2	2,11
3	O	7,4	1,94
4	O	10,5	1,88
5	O	8,6	1,86
6	-	6,3	1,90
7	-	6,5	1,92
8	O	9,4	2,01
9	-	4,9	1,83
10	-	5,5	1,93
11	-	3,2	1,82
12	O	9,4	1,93

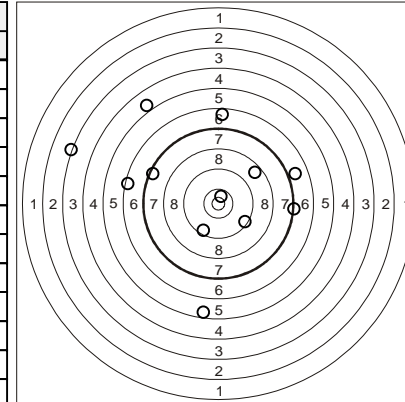

INDIVIDUAL SHOOTING RESULTS

WORLD CUP SOFIA, BULGARIA 2023 - MEN'S QUALIFICATION "A"

Ondrej POLIVKA (CZE)

Heat 1			
	H	P	D
Tot	5/0/5	9,0	8,39
1	O	7,8	-
2	O	10,4	2,04
3	O	9,6	2,21
4	O	8,4	2,03
5	O	8,6	2,11

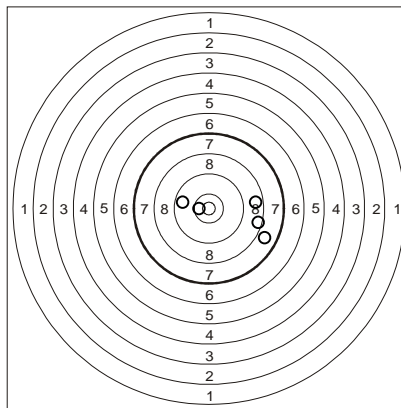

Heat 2			
	H	P	D
Tot	5/0/5	9,2	8,24
1	O	7,7	-
2	O	9,6	2,21
3	O	9,6	2,09
4	O	9,7	1,99
5	O	9,5	1,95

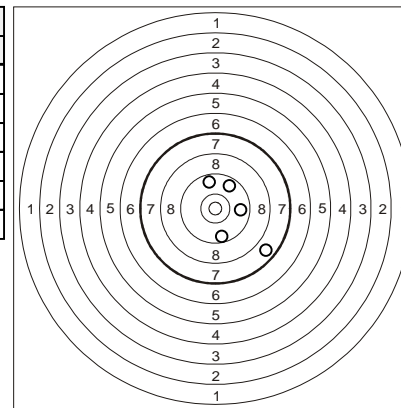

Heat 3			
	H	P	D
Tot	5/4/9	7,6	15,99
1	-	6,3	-
2	O	10,2	2,01
3	-	6,3	2,12
4	-	6,6	2,22
5	O	7,6	1,92
6	O	7,8	1,91
7	O	9,2	1,94
8	-	6,3	1,83
9	O	7,9	2,04

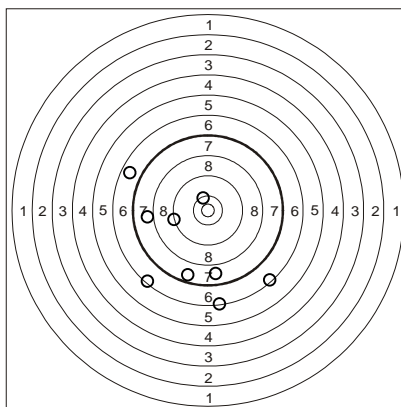

Heat 4			
	H	P	D
Tot	5/9/14	7,4	25,63
1	-	7,2	-
2	O	9,3	2,18
3	-	6,3	1,98
4	-	7,0	1,83
5	-	6,8	1,81
6	-	6,3	1,76
7	-	6,7	1,94
8	-	6,8	1,82
9	O	10,2	1,89
10	-	5,0	1,84
11	O	7,7	2,01
12	O	9,3	2,12
13	-	6,1	2,15
14	O	8,6	2,30

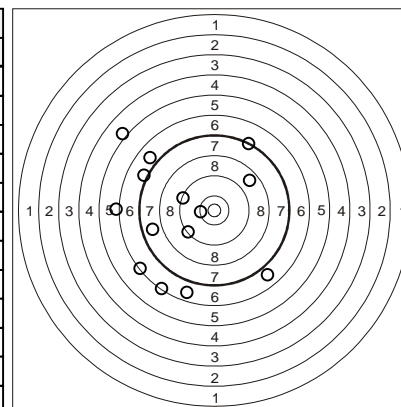

INDIVIDUAL SHOOTING RESULTS

WORLD CUP SOFIA, BULGARIA 2023 - MEN'S QUALIFICATION "A"

Kaoru SHINOKI (JPN)

Heat 1			
	H	P	D
Tot	5/3/8	7,9	15,27
1	-	5,0	-
2	O	9,4	2,08
3	-	7,1	2,16
4	O	7,7	2,11
5	O	8,0	2,21
6	O	9,4	2,25
7	-	6,8	2,23
8	O	9,5	2,23

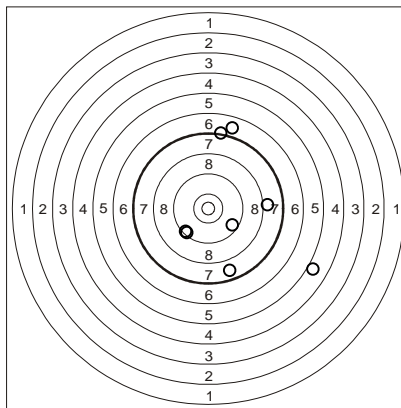

Heat 2			
	H	P	D
Tot	5/3/8	7,8	15,14
1	O	7,6	-
2	-	6,8	2,36
3	O	8,8	2,11
4	O	8,7	2,21
5	O	9,4	2,10
6	-	5,6	2,23
7	-	6,6	2,01
8	O	9,0	2,12

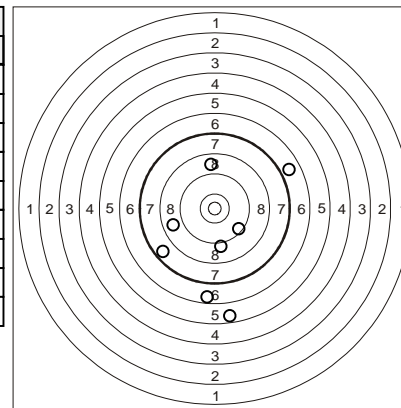

Heat 3			
	H	P	D
Tot	5/3/8	8,0	14,58
1	-	6,9	-
2	-	5,3	2,16
3	O	9,3	2,02
4	O	9,1	2,02
5	O	7,9	2,12
6	-	6,7	2,13
7	O	8,7	2,21
8	O	9,9	1,92

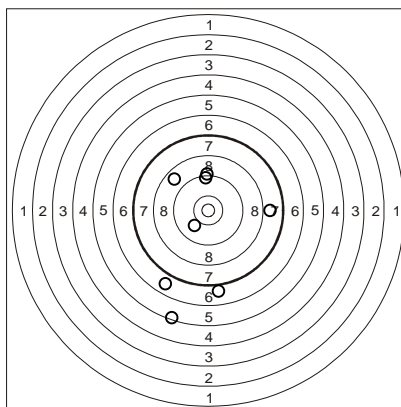

Heat 4			
	H	P	D
Tot	5/2/7	8,3	12,32
1	O	8,1	-
2	O	8,9	2,11
3	O	9,8	2,03
4	O	9,3	2,03
5	-	6,1	2,13
6	-	6,4	2,00
7	O	9,7	2,02

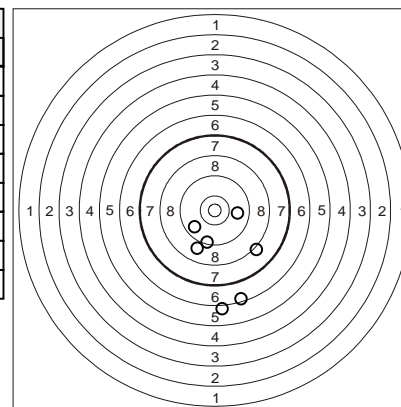

INDIVIDUAL SHOOTING RESULTS

WORLD CUP SOFIA, BULGARIA 2023 - MEN'S QUALIFICATION "A"

Aleksandar VARBANOV (BUL)

Heat 1			
	H	P	D
Tot	5/7/12	6,0	23,55
1	-	2,3	-
2	-	4,3	2,22
3	-	4,3	2,12
4	-	3,0	2,22
5	-	5,4	2,09
6	-	3,5	2,14
7	O	7,3	2,25
8	O	10,5	2,09
9	O	10,2	1,94
10	O	8,0	2,08
11	-	4,7	2,17
12	O	8,4	2,23

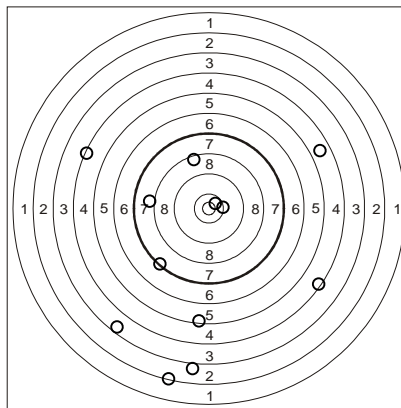

Heat 2			
	H	P	D
Tot	5/8/13	6,9	27,30
1	-	5,7	-
2	-	3,2	2,16
3	O	8,8	2,39
4	-	4,6	2,25
5	-	5,1	1,98
6	O	8,0	2,25
7	O	10,1	2,22
8	-	6,6	2,23
9	-	7,0	2,22
10	O	8,7	2,43
11	-	6,7	2,32
12	-	7,0	2,40
13	O	7,6	2,45

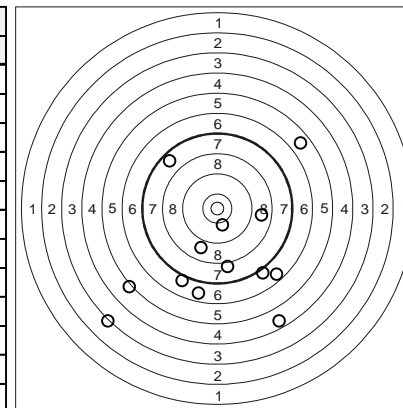

Heat 3			
	H	P	D
Tot	5/3/8	7,4	16,32
1	O	8,6	-
2	-	2,6	2,28
3	-	6,3	2,41
4	-	4,5	2,40
5	O	7,9	2,34
6	O	9,3	2,24
7	O	10,3	2,33
8	O	9,4	2,32

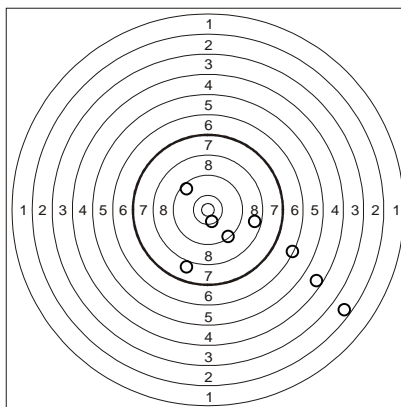

Heat 4			
	H	P	D
Tot	5/5/10	6,7	19,92
1	O	10,2	-
2	O	9,0	2,23
3	O	8,0	2,10
4	-	5,4	2,03
5	-	4,6	2,18
6	O	8,4	2,13
7	-	2,8	2,13
8	-	3,8	2,46
9	-	4,8	2,31
10	O	10,0	2,35

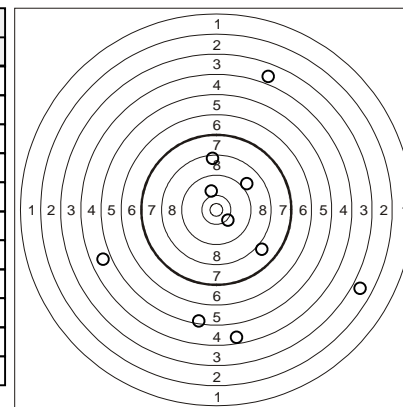

INDIVIDUAL SHOOTING RESULTS

WORLD CUP SOFIA, BULGARIA 2023 - MEN'S QUALIFICATION "A"

Yu ZHANG (CHN)

Heat 1			
	H	P	D
Tot	5/2/7	8,0	10,77
1	O	7,3	-
2	-	6,7	1,91
3	-	5,3	1,60
4	O	10,1	1,71
5	O	9,3	1,82
6	O	8,8	1,80
7	O	8,2	1,93

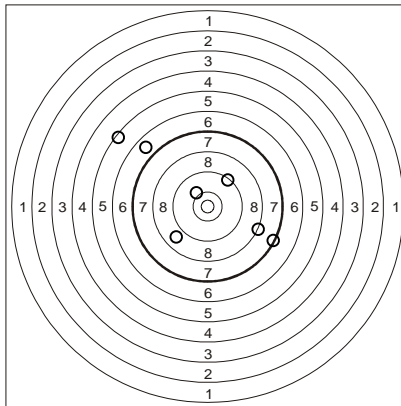

Heat 2			
	H	P	D
Tot	5/2/7	7,7	10,75
1	-	7,1	-
2	-	4,7	1,85
3	O	9,0	1,89
4	O	7,4	1,73
5	O	8,1	1,79
6	O	9,9	1,77
7	O	7,6	1,72

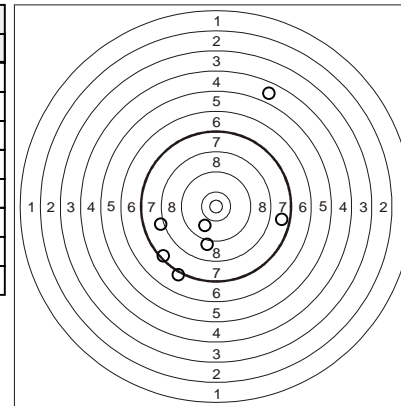

Heat 3			
	H	P	D
Tot	5/3/8	7,6	12,09
1	-	5,6	-
2	-	6,3	1,94
3	O	7,9	1,78
4	O	7,4	1,63
5	-	6,9	1,71
6	O	8,5	1,67
7	O	9,2	1,64
8	O	9,0	1,72

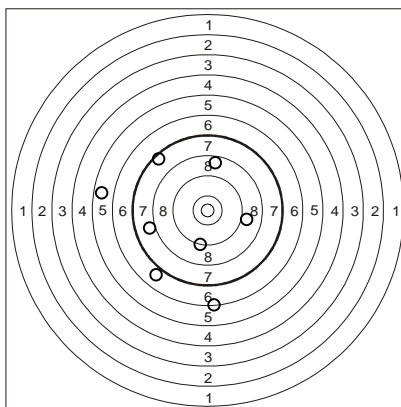

Heat 4			
	H	P	D
Tot	5/2/7	7,6	10,57
1	-	3,6	-
2	O	8,7	1,83
3	-	6,7	1,70
4	O	9,2	1,69
5	O	8,3	1,86
6	O	9,2	1,69
7	O	7,5	1,80

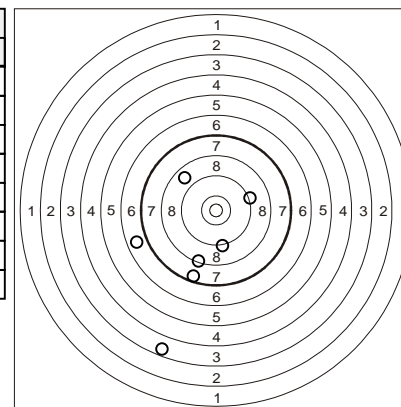

INDIVIDUAL SHOOTING RESULTS

WORLD CUP SOFIA, BULGARIA 2023 - MEN'S QUALIFICATION "A"

Cristian CHAMIZO (ESP)

Heat 1			
	H	P	D
Tot	5/4/9	8,3	16,80
1	-	7,0	-
2	O	9,5	2,24
3	-	6,8	2,00
4	-	7,2	2,01
5	O	10,1	1,98
6	O	9,6	2,17
7	O	8,7	2,02
8	-	6,4	2,25
9	O	9,0	2,13

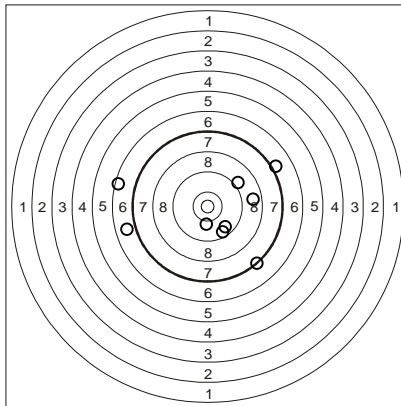

Heat 2			
	H	P	D
Tot	5/1/6	8,5	10,53
1	O	7,7	-
2	-	5,5	2,11
3	O	9,9	2,03
4	O	8,7	2,04
5	O	9,2	2,03
6	O	10,0	2,32

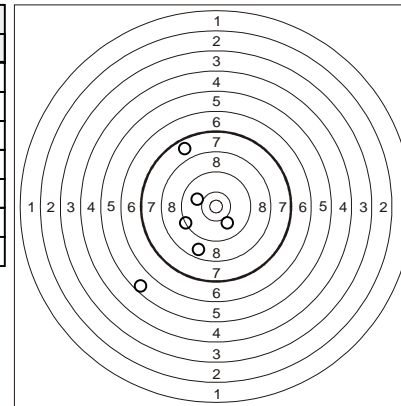

Heat 3			
	H	P	D
Tot	5/1/6	8,5	10,21
1	-	6,2	-
2	O	7,5	2,08
3	O	9,7	2,06
4	O	9,0	1,97
5	O	9,2	1,97
6	O	9,1	2,13

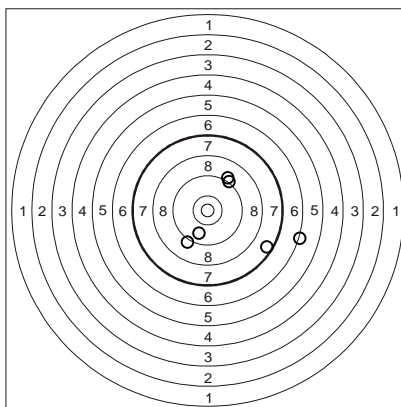

Heat 4			
	H	P	D
Tot	5/1/6	9,0	10,82
1	O	10,6	-
2	O	9,0	2,11
3	O	7,8	2,14
4	O	9,1	2,30
5	-	6,9	2,22
6	O	10,4	2,05

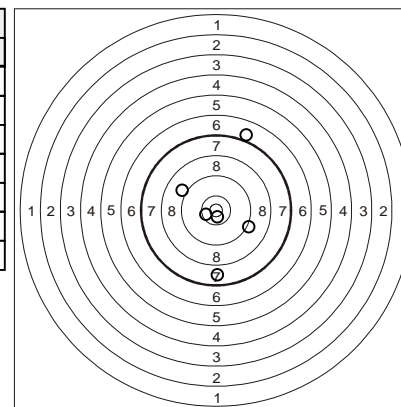

INDIVIDUAL SHOOTING RESULTS

WORLD CUP SOFIA, BULGARIA 2023 - MEN'S QUALIFICATION "A"

Pierre DEJARDIN (FRA)

Heat 1			
	H	P	D
Tot	5/0/5	8,8	7,46
1	O	9,1	-
2	O	9,8	1,92
3	O	7,4	1,81
4	O	9,3	1,86
5	O	8,4	1,87

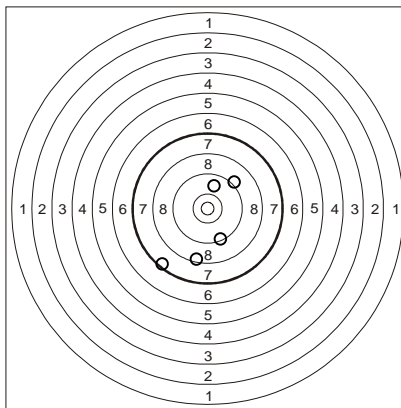

Heat 2			
	H	P	D
Tot	5/0/5	8,7	7,79
1	O	9,0	-
2	O	8,8	2,01
3	O	7,7	2,02
4	O	8,5	1,95
5	O	9,4	1,81

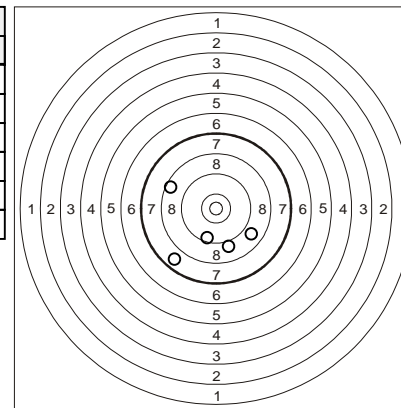

Heat 3			
	H	P	D
Tot	5/2/7	8,0	11,61
1	-	5,0	-
2	O	8,8	2,10
3	O	8,6	1,93
4	-	7,1	1,87
5	O	8,7	1,82
6	O	10,2	2,00
7	O	7,3	1,89

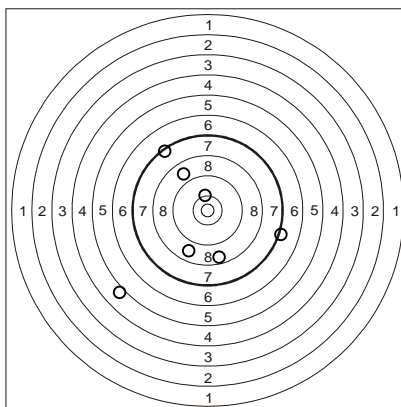

Heat 4			
	H	P	D
Tot	5/0/5	9,2	7,99
1	O	10,2	-
2	O	7,7	2,09
3	O	10,2	2,09
4	O	8,9	1,86
5	O	8,9	1,95

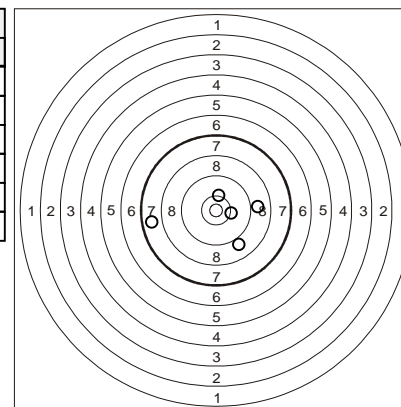

INDIVIDUAL SHOOTING RESULTS

WORLD CUP SOFIA, BULGARIA 2023 - MEN'S QUALIFICATION "A"

Christopher PATTE (FRA)

Heat 1			
	H	P	D
Tot	5/3/8	8,0	15,62
1	O	8,2	-
2	O	7,5	2,40
3	-	4,9	2,29
4	O	9,6	2,14
5	O	10,6	2,15
6	-	7,1	2,19
7	-	6,9	2,12
8	O	9,4	2,33

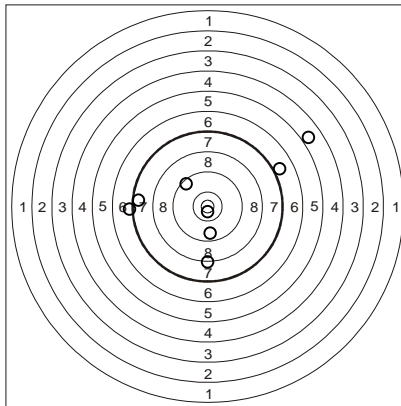

Heat 2			
	H	P	D
Tot	5/2/7	7,7	12,83
1	-	4,0	-
2	O	10,2	2,38
3	-	6,7	2,07
4	O	7,6	2,11
5	O	8,6	2,12
6	O	9,3	2,02
7	O	7,8	2,13

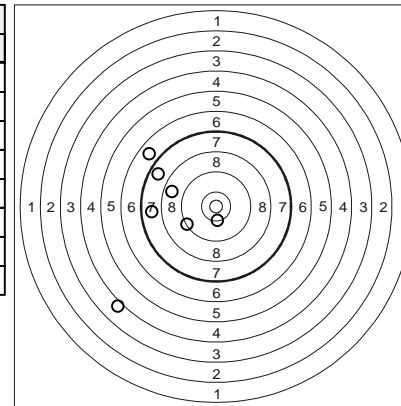

Heat 3			
	H	P	D
Tot	5/1/6	8,4	12,86
1	O	9,6	-
2	O	8,8	2,42
3	O	8,9	2,01
4	-	5,8	2,05
5	O	9,0	2,09
6	O	8,4	4,29

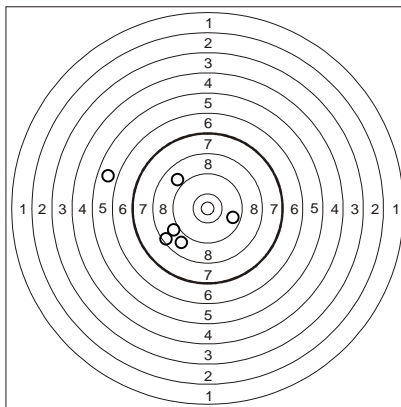

Heat 4			
	H	P	D
Tot	5/3/8	8,2	15,37
1	-	7,0	-
2	-	6,6	2,36
3	O	8,4	2,24
4	O	9,3	2,08
5	-	6,8	2,23
6	O	9,5	2,13
7	O	8,7	2,20
8	O	9,5	2,13

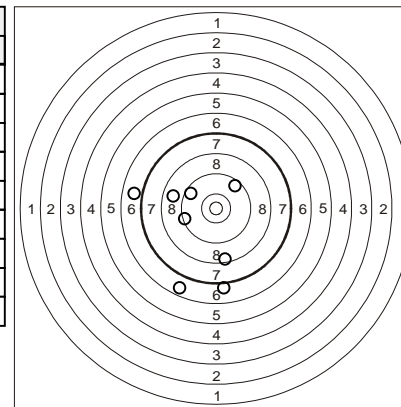

INDIVIDUAL SHOOTING RESULTS

WORLD CUP SOFIA, BULGARIA 2023 - MEN'S QUALIFICATION "A"

Denis KOLEV (BUL)

Heat 1			
	H	P	D
Tot	5/2/7	6,4	12,19
1	O	7,5	-
2	O	7,3	2,15
3	O	7,7	1,99
4	-	3,7	1,77
5	-	2,4	2,09
6	O	9,1	2,21
7	O	7,4	1,98

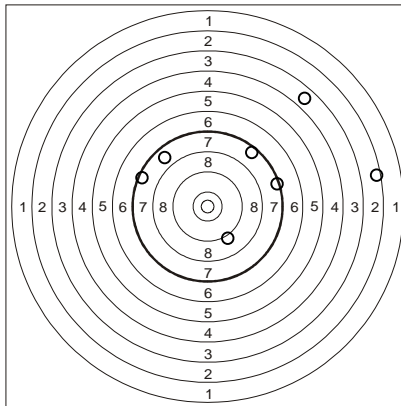

Heat 2			
	H	P	D
Tot	5/1/6	8,1	10,06
1	O	10,1	-
2	-	5,9	2,24
3	O	8,1	1,86
4	O	7,7	1,95
5	O	8,3	1,97
6	O	8,4	2,04

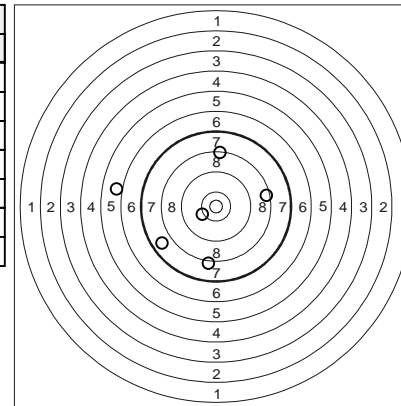

Heat 3			
	H	P	D
Tot	5/3/8	7,6	13,88
1	-	4,5	-
2	O	7,5	2,20
3	-	7,1	2,12
4	O	9,7	1,74
5	-	6,8	1,84
6	O	8,2	2,11
7	O	8,6	1,92
8	O	8,1	1,95

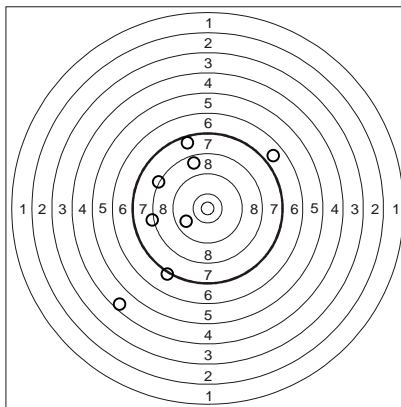

Heat 4			
	H	P	D
Tot	5/2/7	8,0	12,02
1	-	6,6	-
2	O	8,4	2,00
3	-	7,0	2,21
4	O	7,4	2,10
5	O	9,3	1,99
6	O	8,7	1,90
7	O	8,4	1,82

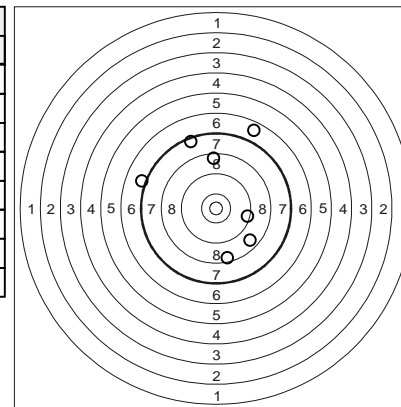

INDIVIDUAL SHOOTING RESULTS

WORLD CUP SOFIA, BULGARIA 2023 - MEN'S QUALIFICATION "A"

Titas PURONAS (LTU)

Heat 1			
	H	P	D
Tot	5/3/8	7,2	13,17
1	O	9,2	-
2	-	3,9	2,09
3	O	8,7	1,75
4	-	7,2	1,91
5	O	10,4	1,92
6	O	7,6	1,81
7	-	2,1	1,76
8	O	8,3	1,93

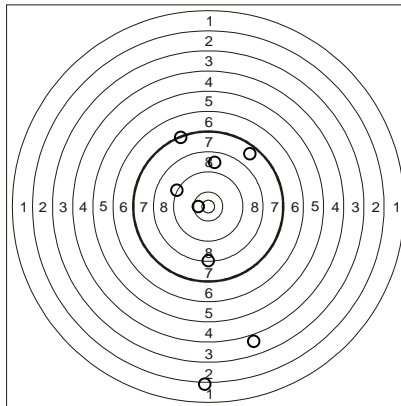

Heat 2			
	H	P	D
Tot	5/3/8	7,7	13,12
1	-	3,6	-
2	O	9,9	1,96
3	O	7,6	1,89
4	-	6,6	1,74
5	O	9,0	1,94
6	O	8,3	1,81
7	-	6,9	1,84
8	O	9,8	1,94

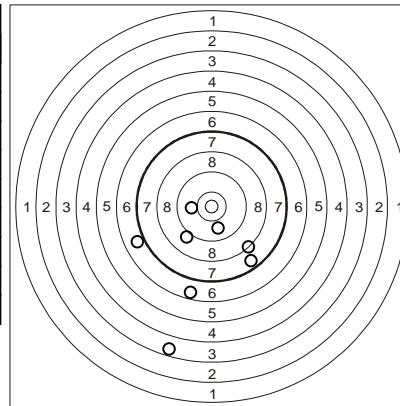

Heat 3			
	H	P	D
Tot	5/10/15	6,7	28,26
1	O	9,6	-
2	-	5,0	1,98
3	O	10,0	1,96
4	-	2,6	1,93
5	O	10,8	1,91
6	-	5,6	1,90
7	-	4,0	1,73
8	-	7,1	1,96
9	-	5,9	1,92
10	-	6,2	2,91
11	-	1,0	2,03
12	-	6,6	2,08
13	-	7,1	1,88
14	O	8,0	2,02
15	O	10,6	2,05

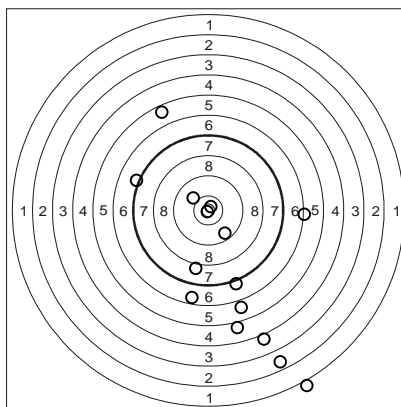

Heat 4			
	H	P	D
Tot	5/4/9	7,2	15,07
1	-	5,6	-
2	-	6,5	1,95
3	O	8,0	1,93
4	O	9,5	1,93
5	-	7,2	1,80
6	O	8,3	2,02
7	-	4,1	1,74
8	O	7,8	1,88
9	O	7,4	1,82

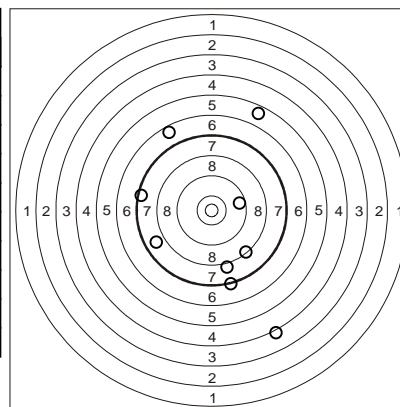

INDIVIDUAL SHOOTING RESULTS

WORLD CUP SOFIA, BULGARIA 2023 - MEN'S QUALIFICATION "A"

Dominik OLEJARZ (GER)

Heat 1			
	H	P	D
Tot	5/3/8	7,3	13,72
1	O	9,4	-
2	-	4,3	1,91
3	O	9,0	1,97
4	-	6,5	1,91
5	O	7,3	2,01
6	-	5,9	2,04
7	O	8,3	1,83
8	O	7,8	2,05

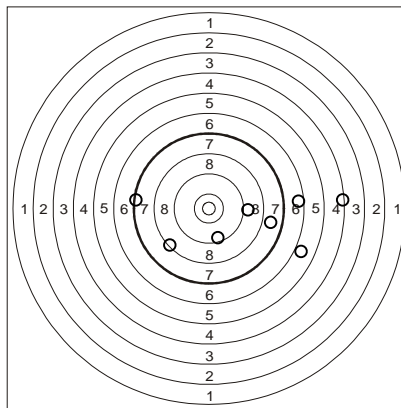

Heat 2			
	H	P	D
Tot	5/0/5	8,6	6,90
1	O	7,6	-
2	O	9,6	1,77
3	O	8,7	1,64
4	O	9,2	1,70
5	O	7,9	1,79

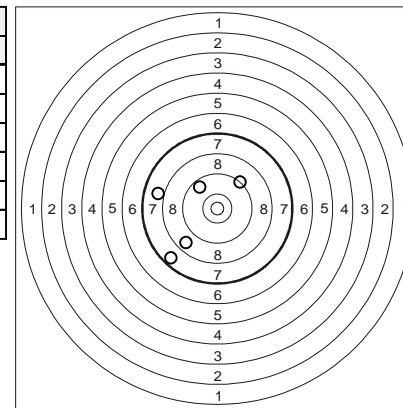

Heat 3			
	H	P	D
Tot	5/8/13	6,9	25,48
1	-	3,3	-
2	-	7,0	2,06
3	-	6,4	1,99
4	O	8,6	2,15
5	O	8,2	1,94
6	O	7,8	2,01
7	O	8,6	2,04
8	-	3,7	1,94
9	-	7,2	2,13
10	-	7,2	2,40
11	-	6,7	2,57
12	-	6,4	2,12
13	O	9,2	2,13

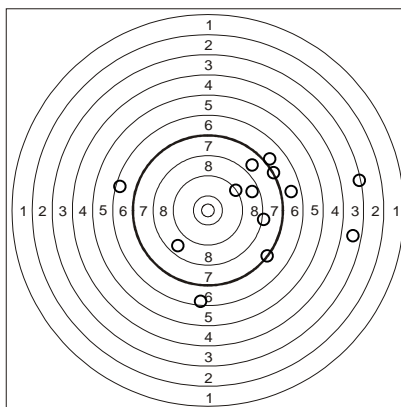

Heat 4			
	H	P	D
Tot	5/6/11	7,2	21,11
1	-	4,8	-
2	-	6,4	2,17
3	O	8,0	1,92
4	-	5,1	1,83
5	-	6,7	3,00
6	O	9,5	2,04
7	O	10,3	2,01
8	-	5,8	1,94
9	O	8,5	1,99
10	-	6,0	2,02
11	O	8,6	2,19

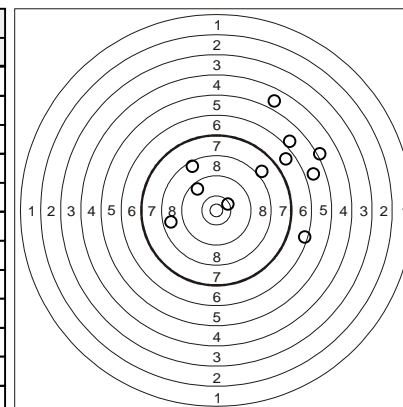

INDIVIDUAL SHOOTING RESULTS

WORLD CUP SOFIA, BULGARIA 2023 - MEN'S QUALIFICATION "A"

Giuseppe PARISI (ITA)

Heat 1			
	H	P	D
Tot	5/6/11	7,4	21,12
1	-	7,1	-
2	-	6,8	2,13
3	-	6,3	1,89
4	O	8,2	2,08
5	O	7,9	2,04
6	O	8,6	2,12
7	-	5,7	2,01
8	-	7,0	2,05
9	-	7,1	2,21
10	O	7,5	2,48
11	O	8,7	2,11

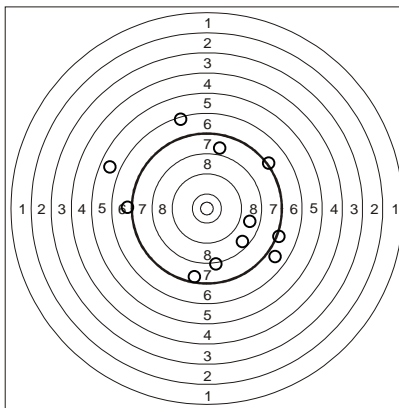

Heat 2			
	H	P	D
Tot	5/4/9	7,9	16,08
1	O	8,9	-
2	O	10,0	2,08
3	O	8,5	1,95
4	-	7,1	1,84
5	-	5,8	1,90
6	-	6,4	2,04
7	O	9,7	2,10
8	-	6,8	2,05
9	O	7,6	2,12

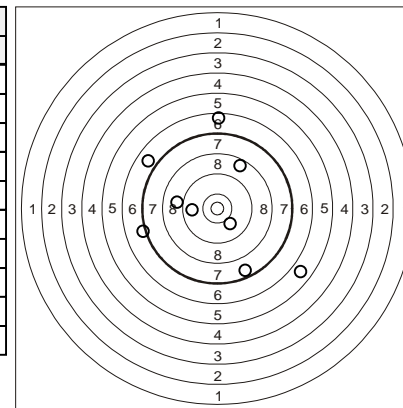

Heat 3			
	H	P	D
Tot	5/1/6	8,5	9,73
1	-	6,8	-
2	O	9,4	2,13
3	O	9,2	1,90
4	O	10,2	1,76
5	O	7,5	1,94
6	O	7,6	2,00

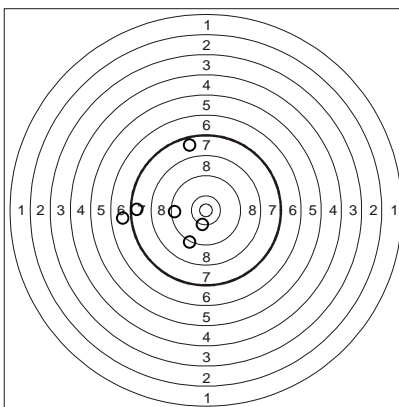

Heat 4			
	H	P	D
Tot	5/4/9	7,1	15,22
1	O	9,3	-
2	-	2,8	1,69
3	O	8,2	1,73
4	O	8,5	1,80
5	O	8,6	1,74
6	-	4,5	1,84
7	-	7,1	1,94
8	-	5,3	2,36
9	O	9,4	2,12

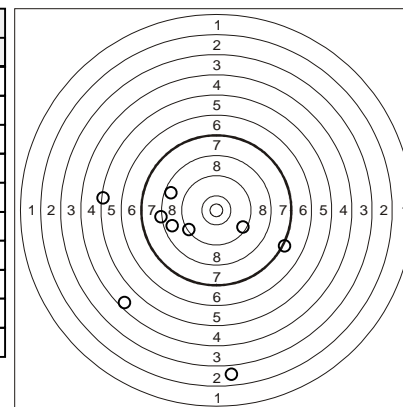

INDIVIDUAL SHOOTING RESULTS

WORLD CUP SOFIA, BULGARIA 2023 - MEN'S QUALIFICATION "A"

Emil GROZDANOV (BUL)

Heat 1			
	H	P	D
Tot	5/1/6	8,2	10,85
1	O	8,3	-
2	O	9,0	2,31
3	-	6,0	2,05
4	O	8,3	2,03
5	O	9,8	2,18
6	O	7,6	2,28

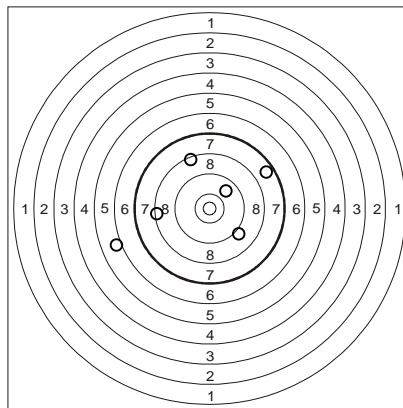

Heat 2			
	H	P	D
Tot	5/0/5	9,1	9,14
1	O	9,7	-
2	O	8,4	2,26
3	O	9,5	2,35
4	O	10,4	2,23
5	O	7,6	2,30

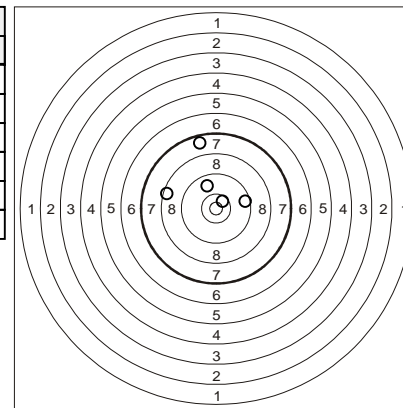

Heat 3			
	H	P	D
Tot	5/1/6	8,4	11,73
1	-	6,6	-
2	O	8,6	2,63
3	O	9,0	2,29
4	O	8,8	2,23
5	O	8,0	2,25
6	O	9,4	2,33

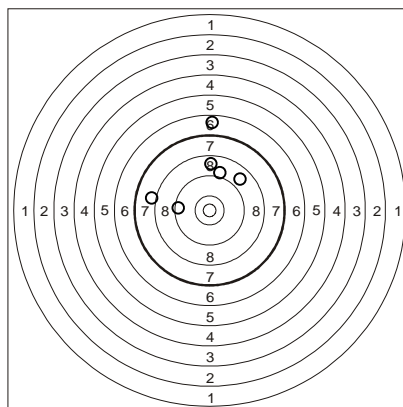

Heat 4			
	H	P	D
Tot	5/4/9	7,9	17,59
1	O	9,8	-
2	-	6,3	2,23
3	-	6,7	2,23
4	-	6,9	2,12
5	O	9,5	2,10
6	-	6,0	2,03
7	O	9,2	2,24
8	O	8,8	2,10
9	O	8,0	2,54

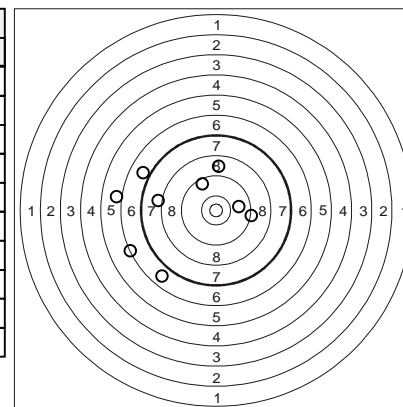

INDIVIDUAL SHOOTING RESULTS

WORLD CUP SOFIA, BULGARIA 2023 - MEN'S QUALIFICATION "A"

Moutaz MOHAMED (EGY)

Heat 1			
	H	P	D
Tot	5/2/7	7,8	10,20
1	O	10,4	-
2	O	8,7	1,63
3	O	8,2	1,63
4	O	8,3	1,70
5	-	3,2	1,71
6	-	6,4	1,78
7	O	9,2	1,75

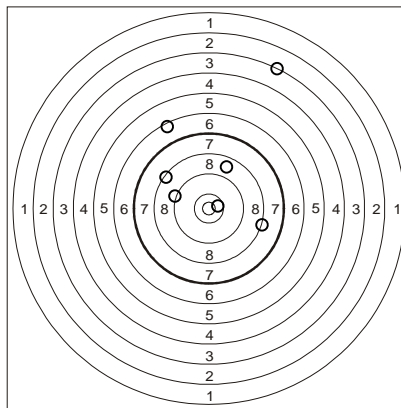

Heat 2			
	H	P	D
Tot	5/5/10	7,4	15,03
1	O	7,9	-
2	-	6,3	1,62
3	O	9,1	1,58
4	-	6,7	1,59
5	-	4,4	1,65
6	-	5,4	1,60
7	O	9,8	1,54
8	O	9,2	1,64
9	-	7,0	1,60
10	O	8,0	2,21

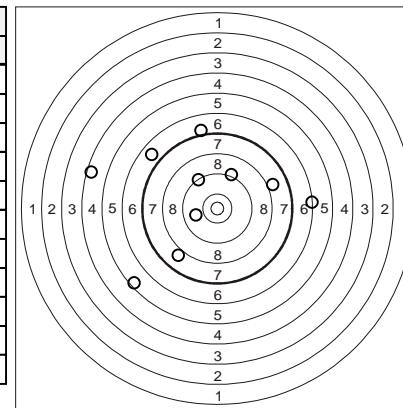

Heat 3			
	H	P	D
Tot	5/2/7	7,5	9,74
1	-	4,9	-
2	-	7,0	1,99
3	O	7,9	1,56
4	O	8,9	1,54
5	O	8,0	1,56
6	O	8,2	1,49
7	O	7,3	1,60

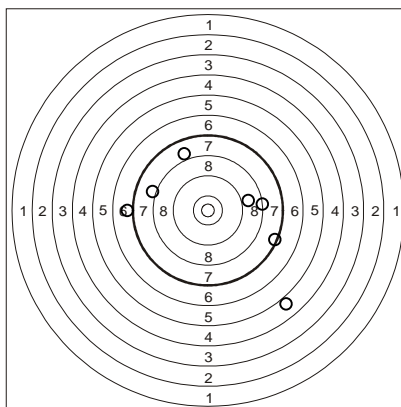

Heat 4			
	H	P	D
Tot	5/3/8	7,0	11,75
1	-	4,5	-
2	-	6,7	1,87
3	O	7,7	1,57
4	O	7,7	1,71
5	O	7,6	1,54
6	-	4,7	1,66
7	O	9,8	1,84
8	O	7,4	1,56

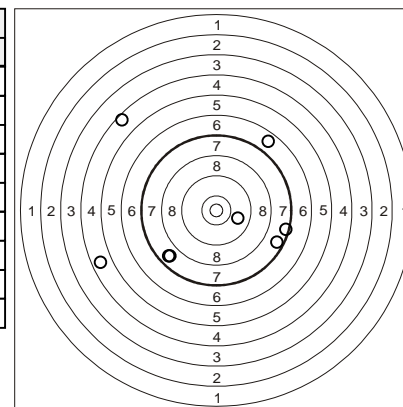

INDIVIDUAL SHOOTING RESULTS

WORLD CUP SOFIA, BULGARIA 2023 - MEN'S QUALIFICATION "A"

Daniel LAWRYNOWICZ (POL)

Heat 1			
	H	P	D
Tot	5/4/9	7,5	15,55
1	-	6,0	-
2	O	9,2	2,16
3	-	5,6	1,98
4	-	7,1	1,94
5	O	7,7	2,09
6	O	9,7	1,86
7	O	7,8	1,92
8	-	4,3	1,80
9	O	9,7	1,80

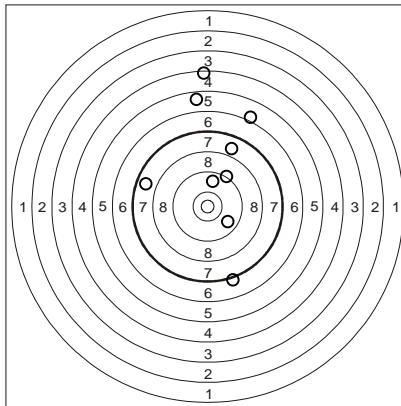

Heat 2			
	H	P	D
Tot	5/1/6	8,4	9,43
1	-	6,2	-
2	O	8,7	1,85
3	O	7,9	1,70
4	O	9,2	1,84
5	O	9,5	1,96
6	O	8,9	2,08

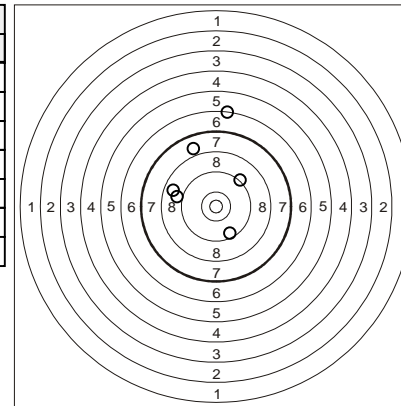

Heat 3			
	H	P	D
Tot	5/1/6	8,5	11,85
1	-	6,8	-
2	O	9,5	3,95
3	O	8,2	2,03
4	O	9,7	1,99
5	O	8,7	1,76
6	O	7,9	2,12

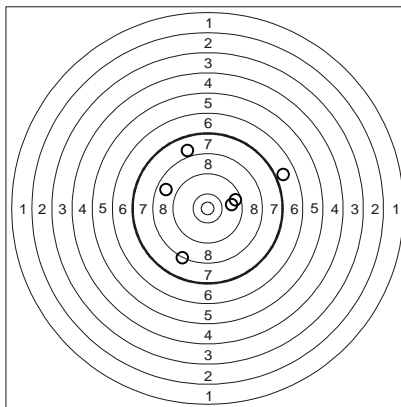

Heat 4			
	H	P	D
Tot	5/4/9	7,8	16,31
1	O	8,4	-
2	O	9,5	2,84
3	O	10,5	1,95
4	-	6,2	1,70
5	-	6,5	1,86
6	O	8,3	1,97
7	-	5,9	1,75
8	-	6,5	2,18
9	O	8,4	2,06

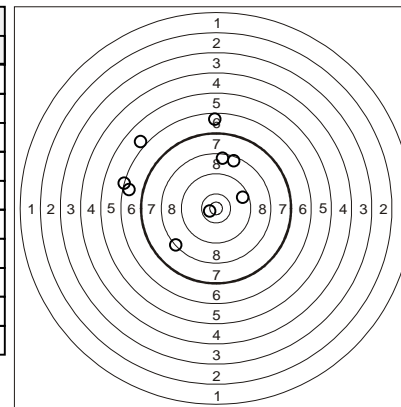

INDIVIDUAL SHOOTING RESULTS

WORLD CUP SOFIA, BULGARIA 2023 - MEN'S QUALIFICATION "A"

Vasilii LUKIANOV (KGZ)

Heat 1			
	H	P	D
Tot	5/2/7	7,0	14,06
1	O	8,0	-
2	-	6,7	3,33
3	O	7,4	2,05
4	-	0,0	2,03
5	O	8,9	2,21
6	O	9,3	2,09
7	O	8,5	2,35

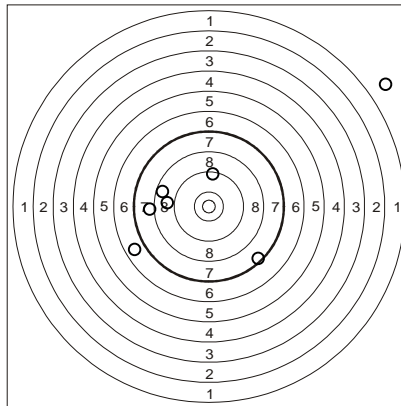

Heat 2			
	H	P	D
Tot	5/8/13	6,2	24,50
1	-	6,3	-
2	-	4,8	2,07
3	-	4,2	2,01
4	-	5,1	2,06
5	O	9,9	1,89
6	O	9,7	2,01
7	-	2,3	1,90
8	-	6,0	2,03
9	-	5,4	2,12
10	O	8,3	2,11
11	O	7,7	2,03
12	-	4,1	2,05
13	O	7,4	2,22

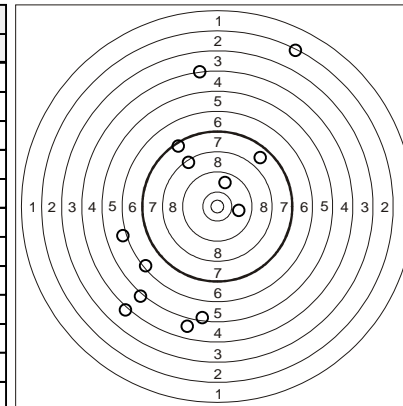

Heat 3			
	H	P	D
Tot	5/5/10	7,1	19,40
1	O	7,3	-
2	-	6,8	2,00
3	-	3,8	1,91
4	O	9,1	2,21
5	-	7,0	2,16
6	-	4,2	1,94
7	-	6,9	2,49
8	O	9,7	2,14
9	O	8,6	2,21
10	O	7,5	2,34

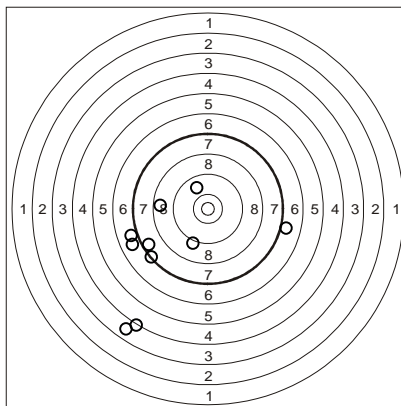

Heat 4			
	H	P	D
Tot	5/6/11	6,7	23,68
1	-	2,0	-
2	-	5,6	2,34
3	O	10,1	2,05
4	-	7,1	2,09
5	-	6,6	2,05
6	O	8,5	2,52
7	O	7,9	2,92
8	O	7,5	2,24
9	-	6,6	2,31
10	-	3,1	2,61
11	O	8,5	2,55

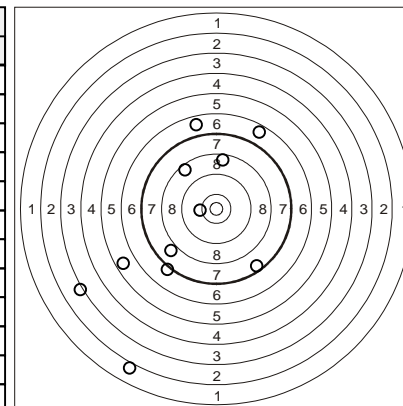

INDIVIDUAL SHOOTING RESULTS

WORLD CUP SOFIA, BULGARIA 2023 - MEN'S QUALIFICATION "A"

Lubomir GERMANOV (BUL)

Heat 1			
	H	P	D
Tot	5/5/10	7,4	17,72
1	-	6,4	-
2	O	7,7	2,07
3	-	5,0	2,06
4	O	7,3	2,04
5	-	6,3	2,00
6	-	7,0	1,82
7	O	8,1	1,82
8	O	9,1	1,95
9	-	7,0	2,04
10	O	10,4	1,92

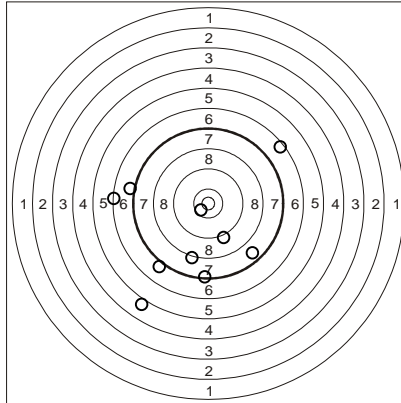

Heat 2			
	H	P	D
Tot	5/3/8	8,3	13,17
1	O	10,7	-
2	O	8,4	1,99
3	-	5,7	1,92
4	-	7,0	1,82
5	-	6,9	1,86
6	O	8,7	1,92
7	O	9,0	1,83
8	O	10,0	1,83

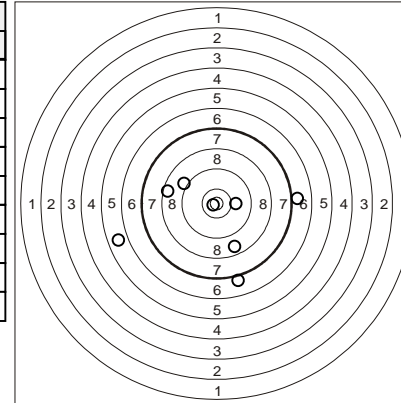

Heat 3			
	H	P	D
Tot	5/4/9	7,9	14,87
1	-	7,2	-
2	O	8,9	1,92
3	-	5,9	1,83
4	O	10,0	1,76
5	-	6,0	1,77
6	O	8,1	1,91
7	-	6,9	1,92
8	O	10,4	1,93
9	O	8,0	1,83

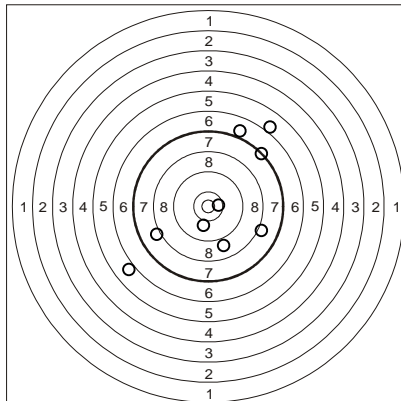

Heat 4			
	H	P	D
Tot	5/11/16	6,7	28,21
1	-	4,5	-
2	-	7,2	1,83
3	-	6,9	1,98
4	-	6,2	1,83
5	-	3,2	1,83
6	-	4,6	1,83
7	-	7,2	1,85
8	O	9,0	1,90
9	-	5,7	1,84
10	-	4,4	1,81
11	-	6,2	2,03
12	O	8,3	2,07
13	-	7,2	1,88
14	O	8,7	1,80
15	O	10,0	1,83
16	O	7,6	1,90

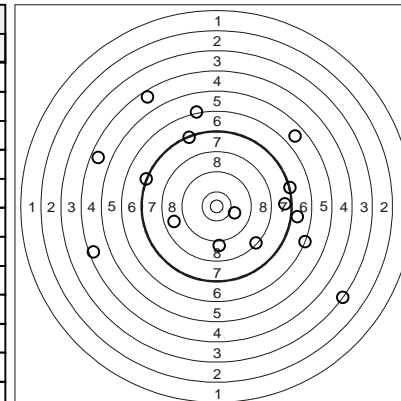

INDIVIDUAL SHOOTING RESULTS

WORLD CUP SOFIA, BULGARIA 2023 - MEN'S QUALIFICATION "A"

Yoshiki ASHIDA (JPN)

Heat 1			
	H	P	D
Tot	5/4/9	7,4	15,70
1	-	7,1	-
2	O	7,4	2,03
3	O	8,5	2,09
4	-	5,3	2,01
5	-	3,9	2,05
6	-	7,2	1,95
7	O	10,3	1,88
8	O	8,2	1,82
9	O	8,5	1,87

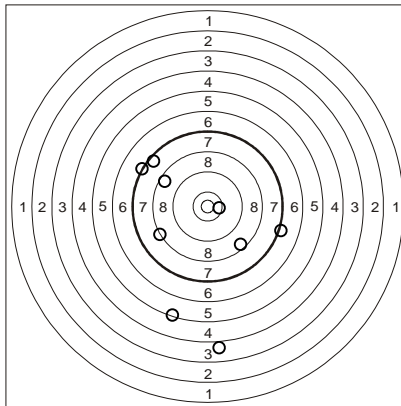

Heat 2			
	H	P	D
Tot	5/2/7	7,8	11,56
1	O	8,8	-
2	O	7,5	1,91
3	O	8,5	1,92
4	-	5,8	1,94
5	-	4,9	1,98
6	O	9,4	1,96
7	O	9,6	1,85

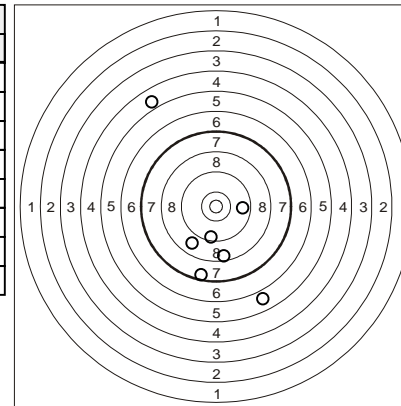

Heat 3			
	H	P	D
Tot	5/4/9	7,0	15,44
1	O	8,0	-
2	O	9,9	2,02
3	O	7,8	2,01
4	O	8,7	1,82
5	-	4,2	1,93
6	-	2,7	1,92
7	-	5,9	1,89
8	-	6,5	1,84
9	O	8,9	2,01

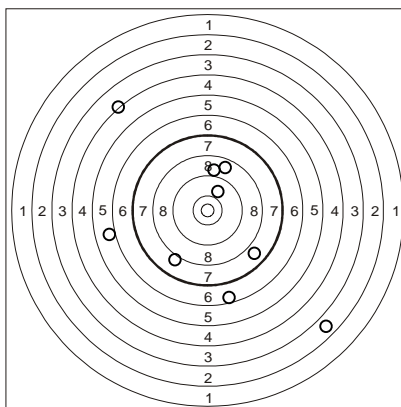

Heat 4			
	H	P	D
Tot	5/2/7	7,7	11,73
1	-	3,7	-
2	O	8,7	2,09
3	O	7,4	2,01
4	-	6,3	1,96
5	O	9,7	1,99
6	O	8,7	1,87
7	O	9,2	1,81

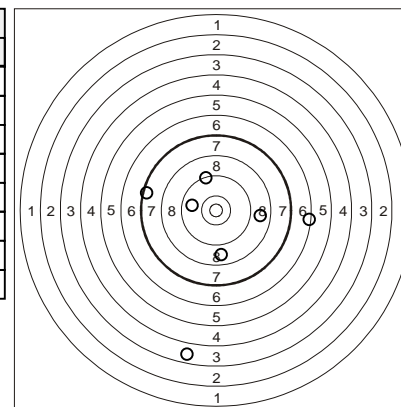

INDIVIDUAL SHOOTING RESULTS

WORLD CUP SOFIA, BULGARIA 2023 - MEN'S QUALIFICATION "A"

Vasil TOPALOV (BUL)

Heat 1			
	H	P	D
Tot	5/7/12	6,5	21,97
1	O	8,9	-
2	-	2,4	1,83
3	-	5,9	1,83
4	-	4,4	3,82
5	O	9,1	1,86
6	-	5,4	1,88
7	-	3,6	1,76
8	-	4,1	1,73
9	-	6,4	1,89
10	O	10,5	1,94
11	O	8,4	1,71
12	O	9,0	1,72

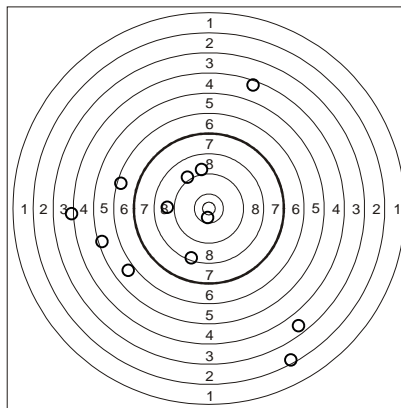

Heat 2			
	H	P	D
Tot	5/5/10	6,6	16,44
1	O	9,4	-
2	-	4,5	1,92
3	O	7,5	1,85
4	-	6,2	1,80
5	-	6,4	1,83
6	O	7,7	1,83
7	-	2,6	1,80
8	O	8,5	1,84
9	-	4,5	1,74
10	O	8,2	1,83

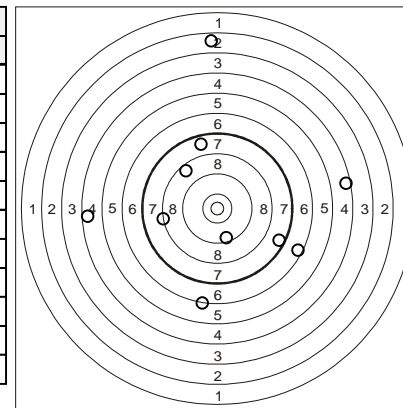

Heat 3			
	H	P	D
Tot	5/7/12	6,2	19,44
1	O	9,0	-
2	-	6,3	1,95
3	O	8,1	2,30
4	O	7,7	1,70
5	O	8,3	1,60
6	-	1,4	1,57
7	-	6,4	1,68
8	-	6,6	1,67
9	-	3,1	1,69
10	-	4,6	1,71
11	-	4,8	1,73
12	O	7,5	1,84

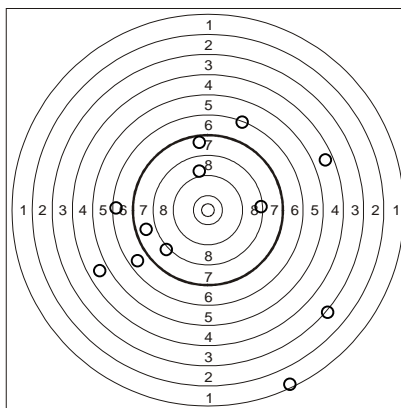

Heat 4			
	H	P	D
Tot	5/4/9	7,0	15,58
1	-	6,5	-
2	O	8,0	1,82
3	-	5,6	1,71
4	O	7,3	1,77
5	-	3,8	1,66
6	O	10,3	1,80
7	O	7,3	3,25
8	-	6,4	1,54
9	O	7,7	2,03

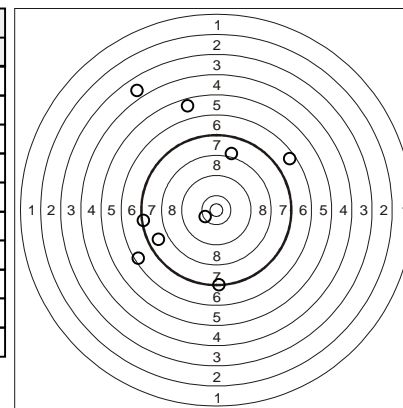

INDIVIDUAL SHOOTING RESULTS

WORLD CUP SOFIA, BULGARIA 2023 - MEN'S QUALIFICATION "A"

Francesco CHUMACERO (BOL)

Heat 1			
	H	P	D
Tot	5/1/6	7,6	8,72
1	-	2,6	-
2	O	8,9	1,93
3	O	7,3	1,72
4	O	8,6	1,63
5	O	10,1	1,71
6	O	8,2	1,73

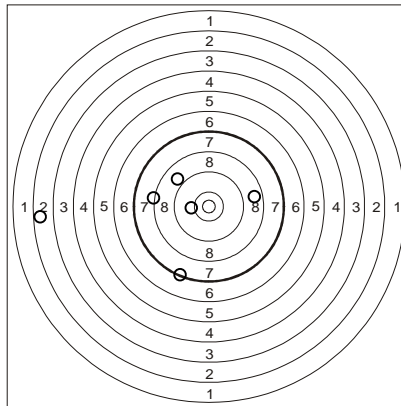

Heat 2			
	H	P	D
Tot	5/7/12	5,9	20,18
1	O	9,4	-
2	-	6,1	1,63
3	O	8,8	2,14
4	-	1,2	1,70
5	-	5,1	1,73
6	O	8,8	1,82
7	-	4,3	1,82
8	-	4,3	1,80
9	O	7,6	1,64
10	-	4,1	1,69
11	-	3,5	2,35
12	O	7,4	1,86

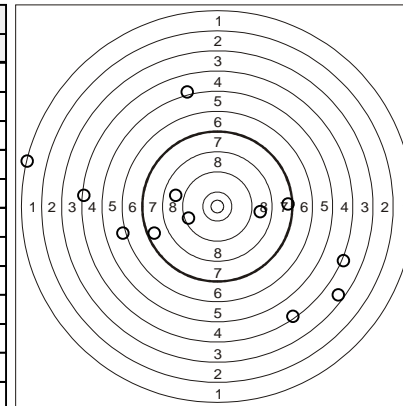

Heat 3			
	H	P	D
Tot	5/5/10	6,4	15,16
1	O	9,1	-
2	-	3,8	1,70
3	O	7,4	1,63
4	-	2,7	1,62
5	-	6,6	1,63
6	-	2,1	1,68
7	-	6,6	1,65
8	O	8,3	1,79
9	O	9,5	1,79
10	O	7,6	1,67

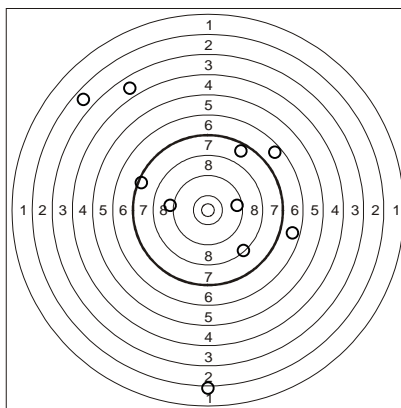

Heat 4			
	H	P	D
Tot	5/3/8	7,5	11,61
1	-	4,8	-
2	O	7,4	1,79
3	O	8,6	1,63
4	-	6,9	1,64
5	O	9,6	1,68
6	O	8,9	1,63
7	-	5,9	1,52
8	O	7,9	1,72

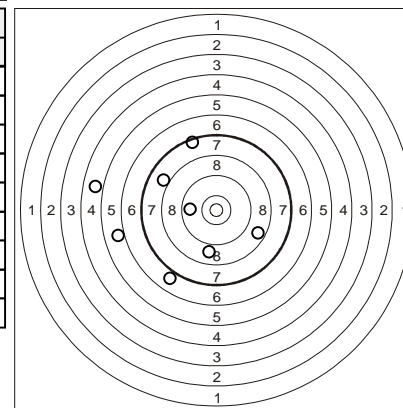

INDIVIDUAL SHOOTING RESULTS

WORLD CUP SOFIA, BULGARIA 2023 - MEN'S QUALIFICATION "A"

Ivan RUSIN (MDA)

Heat 1			
	H	P	D
Tot	5/3/8	7,2	14,55
1	O	10,0	-
2	O	8,4	2,31
3	-	5,1	2,19
4	-	3,6	2,04
5	O	8,4	2,12
6	-	5,7	1,93
7	O	7,8	2,08
8	O	8,7	1,88

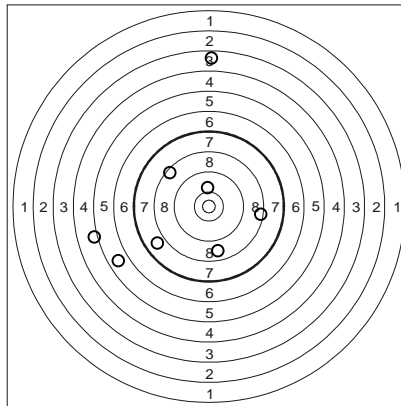

Heat 2			
	H	P	D
Tot	5/5/10	6,9	19,83
1	-	6,9	-
2	O	7,5	2,24
3	O	8,3	2,06
4	-	5,0	2,28
5	O	9,3	2,14
6	-	1,5	2,11
7	-	6,4	2,21
8	-	6,6	2,25
9	O	8,1	2,40
10	O	9,5	2,14

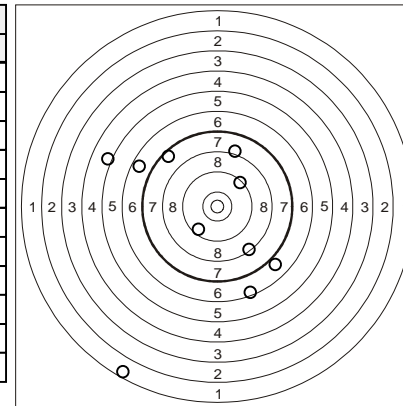

Heat 3			
	H	P	D
Tot	5/1/6	8,7	11,12
1	O	8,3	-
2	-	5,3	2,22
3	O	9,2	2,23
4	O	8,6	2,14
5	O	10,3	2,32
6	O	10,4	2,21

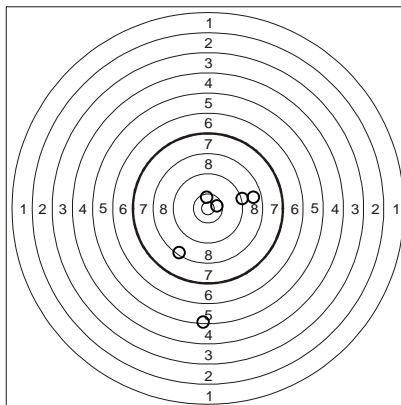

Heat 4			
	H	P	D
Tot	5/3/8	7,6	16,62
1	O	7,9	-
2	O	7,9	2,21
3	O	8,2	2,43
4	-	7,1	2,13
5	O	8,9	2,21
6	-	6,0	2,15
7	-	6,7	2,21
8	O	7,9	3,28

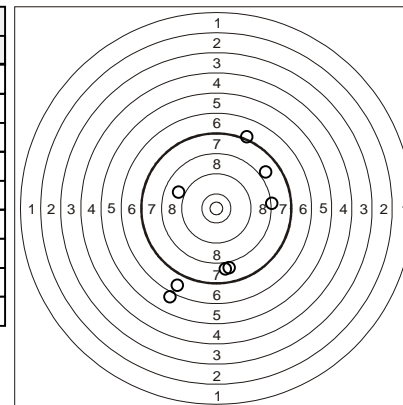

INDIVIDUAL SHOOTING RESULTS

WORLD CUP SOFIA, BULGARIA 2023 - MEN'S QUALIFICATION "A"

Atai ERKINBEKOV (KGZ)

Heat 1			
	H	P	D
Tot	5/3/8	7,1	14,51
1	-	3,7	-
2	-	6,3	1,84
3	O	7,8	1,80
4	O	8,6	1,94
5	O	7,7	2,22
6	-	6,3	1,74
7	O	8,4	2,82
8	O	7,9	2,15

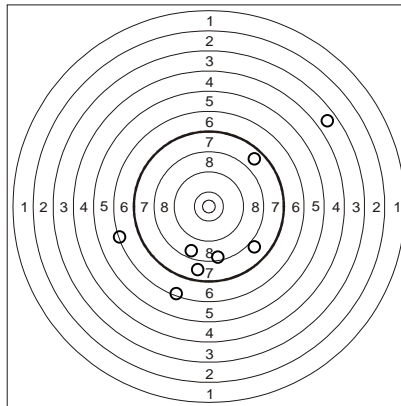

Heat 2			
	H	P	D
Tot	5/5/10	7,5	18,78
1	-	6,7	-
2	O	7,7	1,99
3	O	8,0	1,82
4	-	6,4	1,87
5	-	7,1	2,04
6	O	7,7	2,00
7	-	6,6	1,97
8	O	9,3	1,98
9	-	7,2	2,34
10	O	8,0	2,77

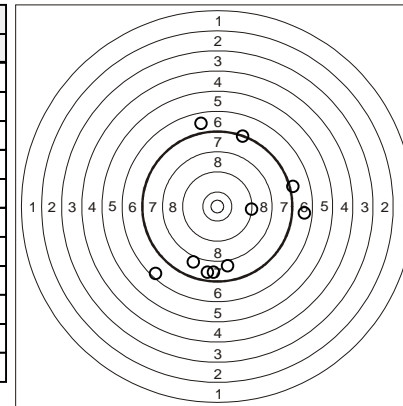

Heat 3			
	H	P	D
Tot	5/3/8	7,9	15,22
1	O	8,4	-
2	O	9,7	2,53
3	-	4,4	2,01
4	-	7,1	1,96
5	-	7,2	2,03
6	O	7,3	2,32
7	O	9,5	2,22
8	O	9,7	2,15

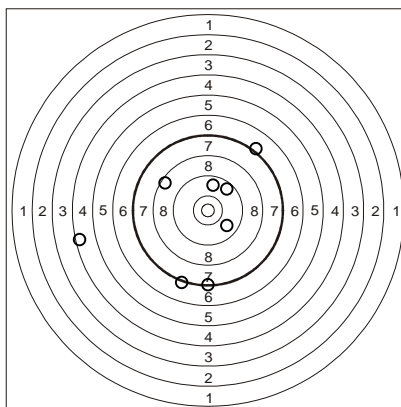

Heat 4			
	H	P	D
Tot	5/5/10	7,9	20,18
1	-	6,7	-
2	-	6,7	2,20
3	-	6,5	1,83
4	-	7,0	2,68
5	O	8,2	2,38
6	O	8,9	2,34
7	-	5,9	2,28
8	O	10,3	2,06
9	O	8,9	2,04
10	O	10,0	2,37

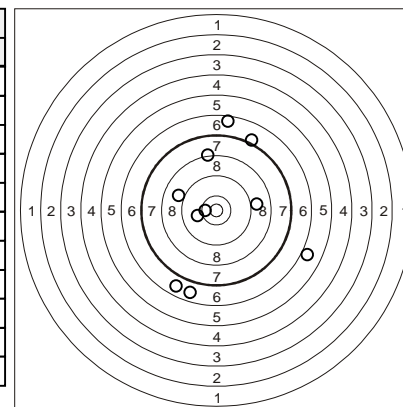

INDIVIDUAL SHOOTING RESULTS

WORLD CUP SOFIA, BULGARIA 2023 - MEN'S QUALIFICATION "A"

Taavi HAVRE (EST)

Heat 1			
	H	P	D
Tot	5/5/10	7,3	20,63
1	-	7,0	-
2	-	6,6	2,10
3	O	7,9	2,15
4	O	9,0	2,41
5	-	6,8	2,11
6	O	9,2	2,47
7	O	9,5	2,21
8	-	5,8	2,11
9	-	3,9	2,32
10	O	7,6	2,75

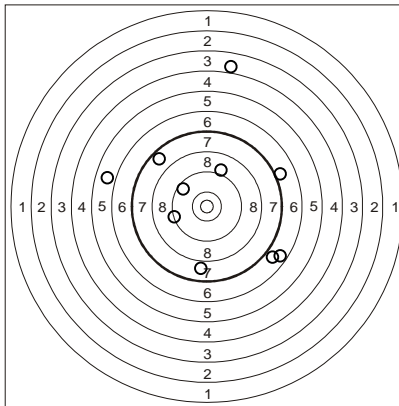

Heat 2			
	H	P	D
Tot	5/6/11	7,0	23,74
1	-	2,8	-
2	-	6,2	2,34
3	O	10,1	2,28
4	-	5,9	2,27
5	O	9,4	1,93
6	O	9,0	2,51
7	O	10,1	2,17
8	-	3,8	3,66
9	-	6,0	2,03
10	-	4,8	2,12
11	O	9,0	2,43

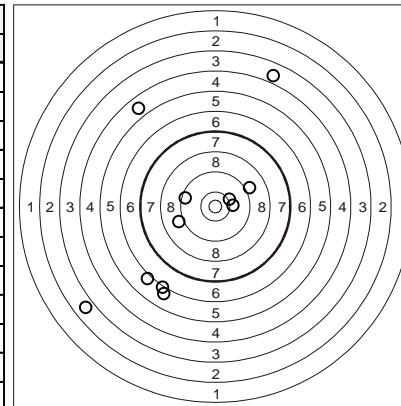

Heat 3			
	H	P	D
Tot	5/2/7	7,7	12,71
1	-	6,5	-
2	O	8,1	2,35
3	-	4,9	2,17
4	O	9,1	2,17
5	O	7,9	1,96
6	O	7,5	2,12
7	O	10,1	1,94

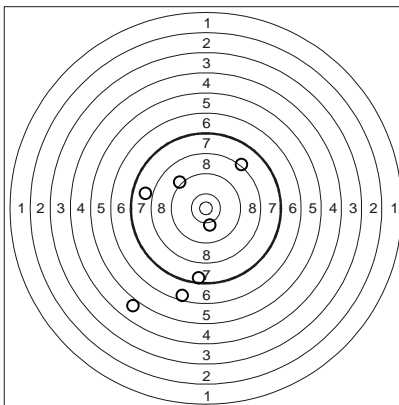

Heat 4			
	H	P	D
Tot	5/7/12	7,4	24,28
1	-	7,2	-
2	O	9,4	2,15
3	-	5,5	1,94
4	-	5,6	2,09
5	O	9,6	2,04
6	-	6,8	2,10
7	-	6,8	2,34
8	-	6,6	2,31
9	O	9,2	2,53
10	-	4,7	2,13
11	O	9,5	2,24
12	O	8,0	2,41

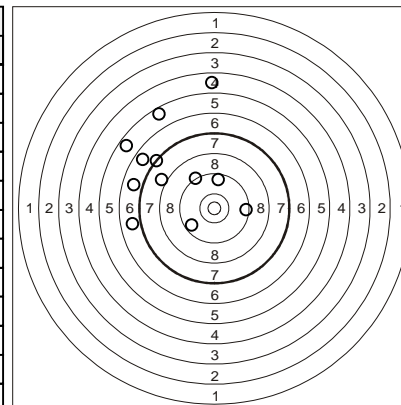

INDIVIDUAL SHOOTING RESULTS

WORLD CUP SOFIA, BULGARIA 2023 - MEN'S QUALIFICATION "A"

0

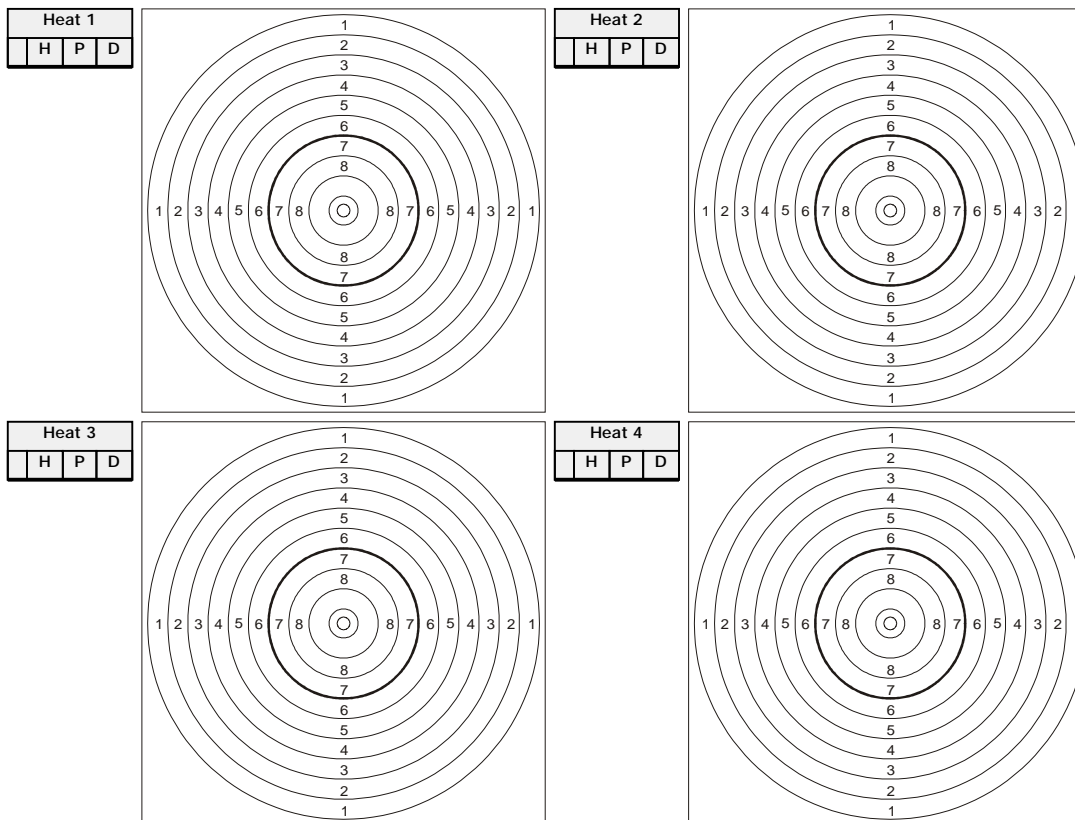

INDIVIDUAL SHOOTING RESULTS

WORLD CUP SOFIA, BULGARIA 2023 - MEN'S QUALIFICATION "A"

0

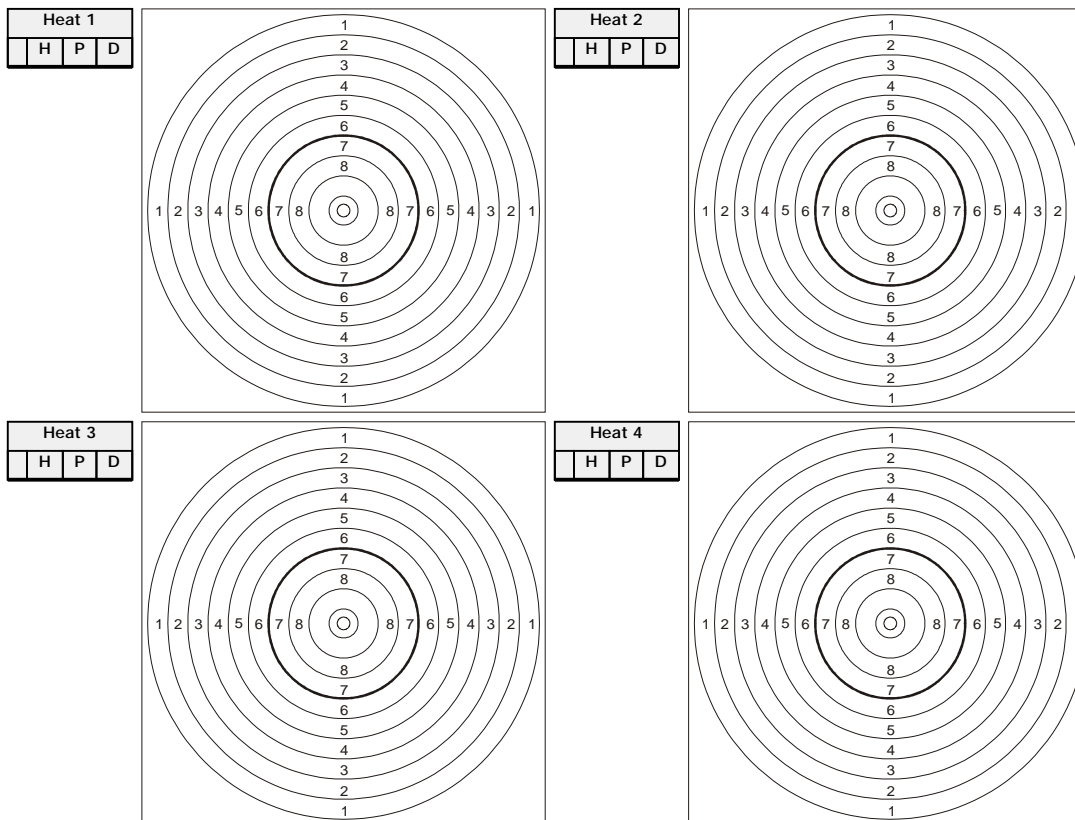

INDIVIDUAL SHOOTING RESULTS

WORLD CUP SOFIA, BULGARIA 2023 - MEN'S QUALIFICATION "A"

0

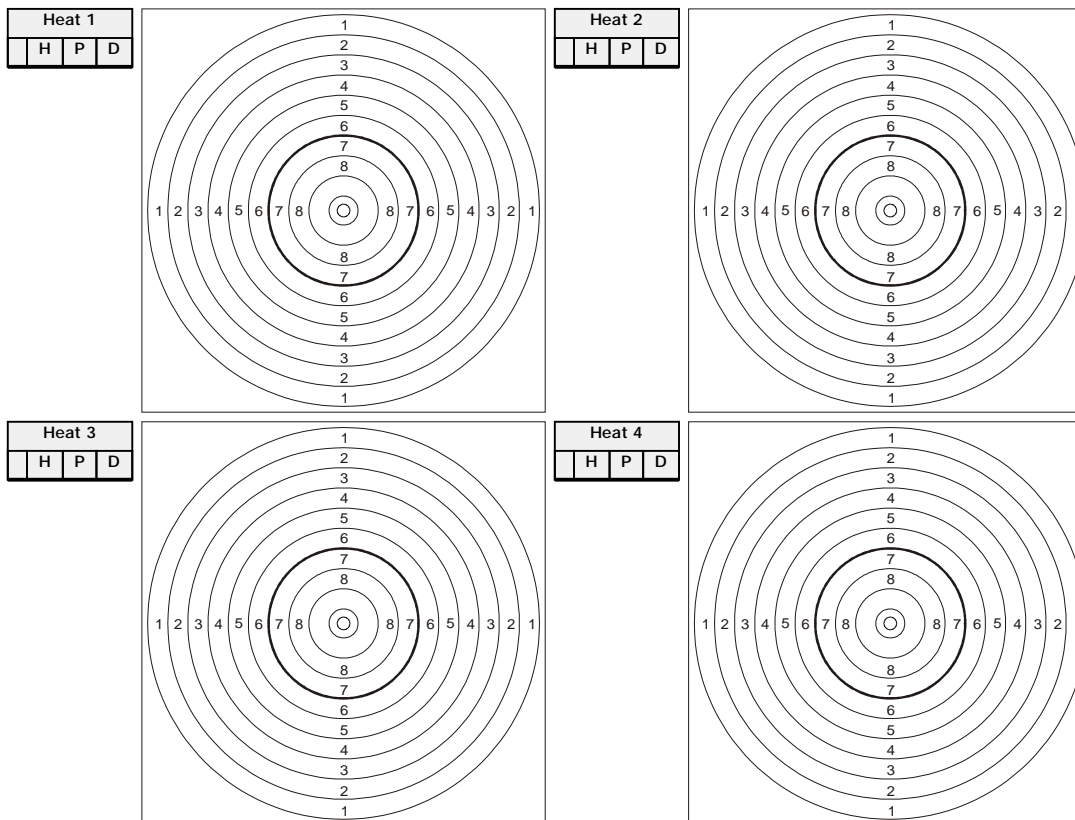

INDIVIDUAL SHOOTING RESULTS

WORLD CUP SOFIA, BULGARIA 2023 - MEN'S QUALIFICATION "A"

0

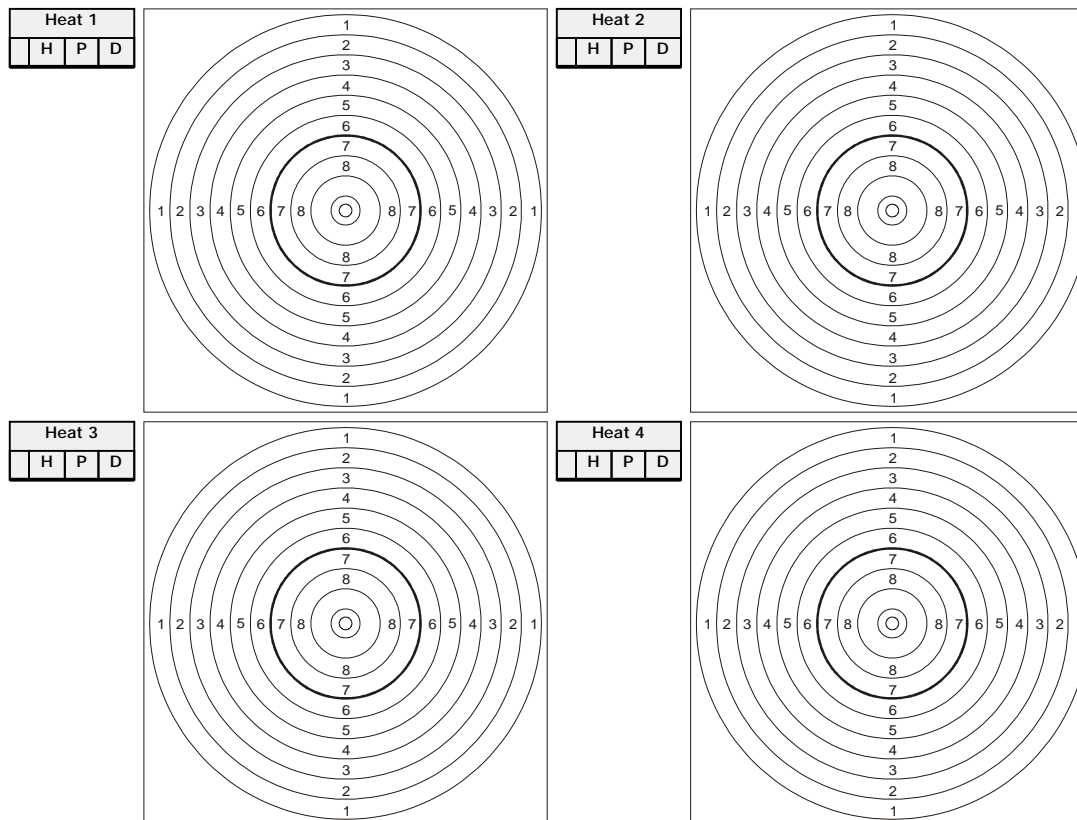

INDIVIDUAL SHOOTING RESULTS

WORLD CUP SOFIA, BULGARIA 2023 - MEN'S QUALIFICATION "A"

0

