

INDIVIDUAL SHOOTING RESULTS

POLISH INTERNATIONAL M.P. TROPHY & EUROPEAN U19 M.P. CUP - WOMEN'S HEAT 1

HARTMANOVA Barbora (CZE)

Heat 1			
	H	P	D
Tot	5/7/12	7,2	27,22
1	-	5,2	-
2	O	8,2	2,42
3	-	4,8	2,26
4	O	8,3	2,37
5	-	6,1	2,25
6	-	6,9	2,24
7	-	6,7	2,23
8	O	9,0	2,23
9	O	9,3	3,44
10	-	5,0	2,38
11	-	6,8	2,68
12	O	10,2	2,72

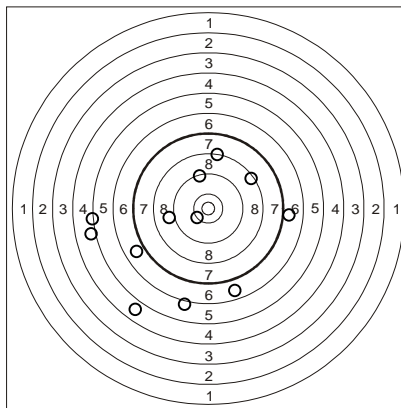

Heat 2			
	H	P	D
Tot	5/2/7	6,8	17,15
1	-	2,2	-
2	-	1,9	2,37
3	O	8,1	2,61
4	O	9,9	4,94
5	O	8,2	2,39
6	O	8,7	2,44
7	O	8,7	2,40

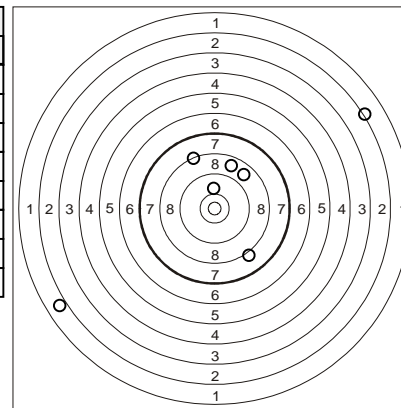

Heat 3			
	H	P	D
Tot	5/10/15	5,7	33,19
1	-	6,9	-
2	O	8,4	2,44
3	-	3,9	2,41
4	O	8,6	2,46
5	-	0,0	1,87
6	-	6,9	2,43
7	-	6,9	2,40
8	-	4,2	2,26
9	-	4,9	2,42
10	O	7,6	2,34
11	-	5,0	2,51
12	-	5,0	2,24
13	-	2,0	2,51
14	O	7,3	2,33
15	O	8,3	2,57

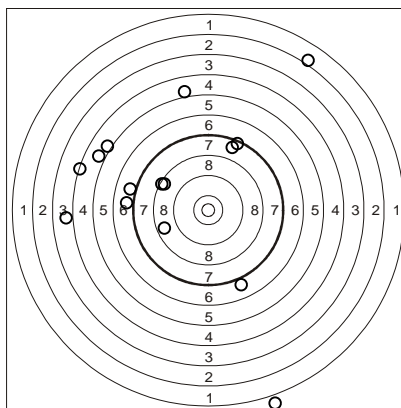

Heat 4			
	H	P	D
Tot	5/7/12	6,7	26,40
1	O	9,7	-
2	-	6,9	2,38
3	O	8,3	2,39
4	-	2,3	2,40
5	-	6,9	2,41
6	-	5,8	2,33
7	-	5,0	2,43
8	O	9,9	2,62
9	-	4,3	2,48
10	-	4,5	2,22
11	O	8,8	2,41
12	O	7,8	2,33

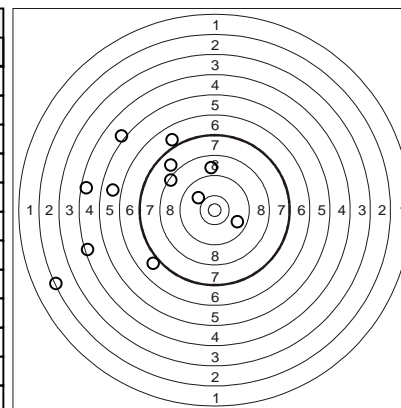

INDIVIDUAL SHOOTING RESULTS

POLISH INTERNATIONAL M.P. TROPHY & EUROPEAN U19 M.P. CUP - WOMEN'S HEAT 1

DOMINIAK Natalia (POL)

Heat 1			
	H	P	D
Tot	5/2/7	7,9	11,50
1	O	7,5	-
2	-	5,8	2,06
3	O	8,1	2,03
4	O	10,5	1,82
5	-	5,5	1,84
6	O	10,5	1,89
7	O	7,4	1,86

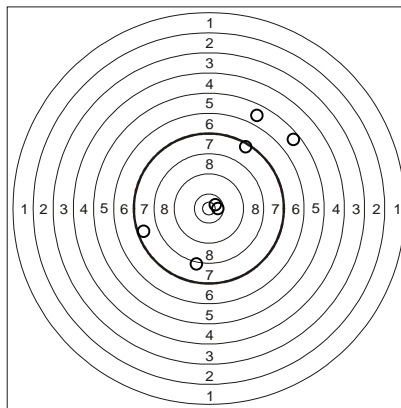

Heat 2			
	H	P	D
Tot	5/3/8	7,8	13,39
1	-	6,6	-
2	O	9,5	1,94
3	O	7,5	2,25
4	O	9,3	1,76
5	-	6,9	1,75
6	O	8,8	1,74
7	-	5,7	1,93
8	O	7,7	2,02

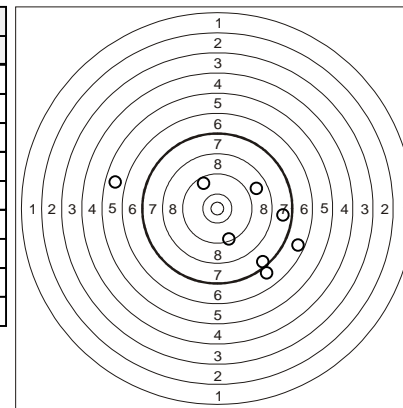

Heat 3			
	H	P	D
Tot	5/6/11	7,3	19,53
1	O	8,9	-
2	-	6,8	1,90
3	O	10,2	2,02
4	-	5,2	1,72
5	-	5,5	1,82
6	O	7,6	1,85
7	O	8,2	1,91
8	-	5,9	1,95
9	-	6,9	2,02
10	-	6,0	2,22
11	O	9,3	2,12

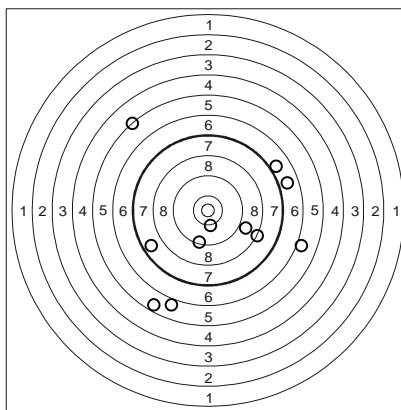

Heat 4			
	H	P	D
Tot	5/5/10	7,1	19,75
1	O	9,9	-
2	-	4,5	2,25
3	O	7,7	2,10
4	-	6,0	2,04
5	-	6,2	2,07
6	O	8,2	2,14
7	-	6,9	1,78
8	-	6,4	2,07
9	O	8,1	2,62
10	O	7,3	2,68

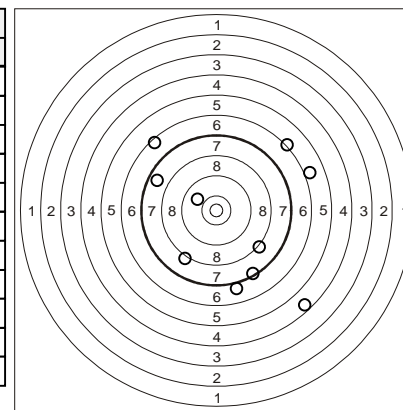

INDIVIDUAL SHOOTING RESULTS

POLISH INTERNATIONAL M.P. TROPHY & EUROPEAN U19 M.P. CUP - WOMEN'S HEAT 1

KAPALA Adrianna (POL)

Heat 1			
	H	P	D
Tot	5/1/6	7,9	8,71
1	O	7,7	-
2	O	8,5	1,78
3	-	5,7	1,67
4	O	8,4	1,89
5	O	8,8	1,64
6	O	8,4	1,73

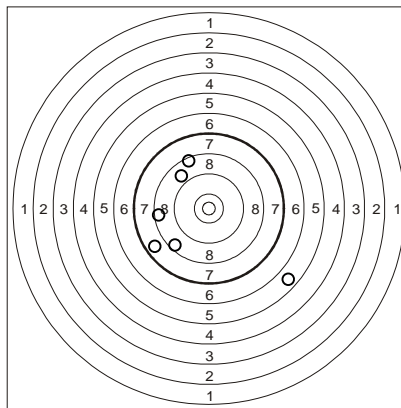

Heat 2			
	H	P	D
Tot	5/4/9	7,3	13,86
1	-	6,9	-
2	O	7,9	1,86
3	-	4,0	1,82
4	O	10,6	1,62
5	O	8,4	1,81
6	-	4,7	1,72
7	-	6,2	1,70
8	O	8,8	1,61
9	O	8,4	1,72

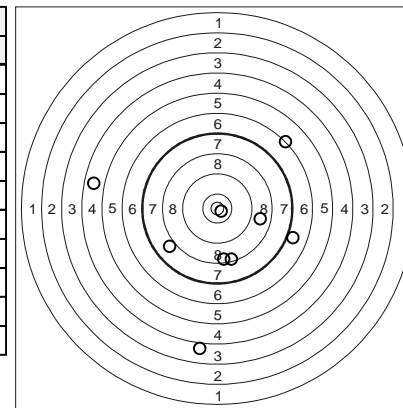

Heat 3			
	H	P	D
Tot	5/0/5	9,3	7,24
1	O	7,8	-
2	O	9,1	1,87
3	O	9,6	1,75
4	O	10,0	1,80
5	O	10,1	1,82

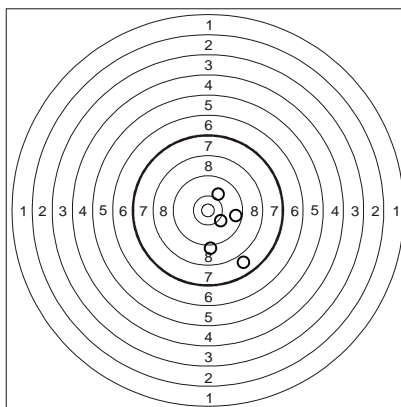

Heat 4			
	H	P	D
Tot	5/6/11	7,1	18,54
1	O	9,1	-
2	O	9,5	1,97
3	-	4,8	1,89
4	O	7,2	1,81
5	-	3,5	1,93
6	O	9,6	1,71
7	-	6,9	1,85
8	-	6,5	1,73
9	-	6,4	1,73
10	-	6,9	1,69
11	O	7,7	2,23

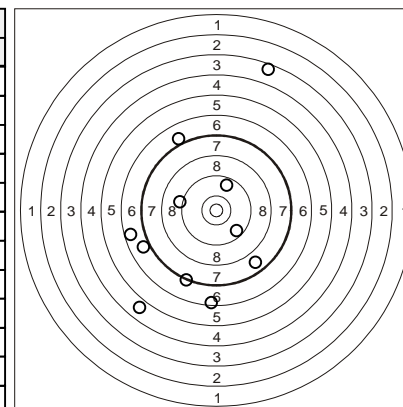

INDIVIDUAL SHOOTING RESULTS

POLISH INTERNATIONAL M.P. TROPHY & EUROPEAN U19 M.P. CUP - WOMEN'S HEAT 1

KARBOWNIK Malgorzata (POL)

Heat 1			
	H	P	D
Tot	5/3/8	7,7	10,52
1	O	7,5	-
2	O	9,7	1,65
3	-	6,9	1,43
4	-	5,6	1,50
5	O	8,3	1,47
6	-	6,9	1,52
7	O	8,1	1,49
8	O	8,3	1,46

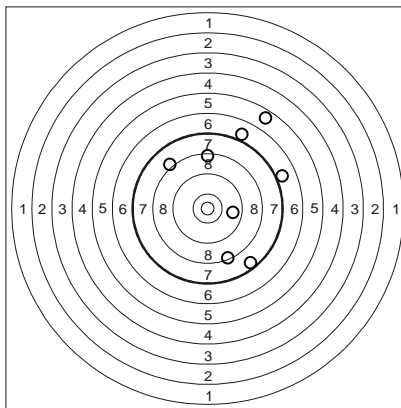

Heat 2			
	H	P	D
Tot	5/2/7	7,7	10,03
1	-	5,1	-
2	O	10,6	1,67
3	O	8,4	1,73
4	O	7,5	1,64
5	O	9,1	1,63
6	-	4,0	1,64
7	O	8,9	1,72

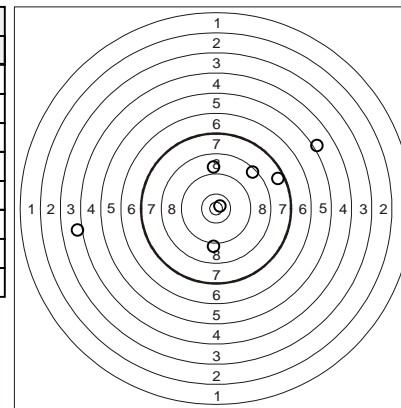

Heat 3			
	H	P	D
Tot	5/1/6	7,6	8,15
1	O	7,9	-
2	O	7,6	1,65
3	-	6,2	1,69
4	O	8,9	1,55
5	O	7,7	1,63
6	O	7,3	1,63

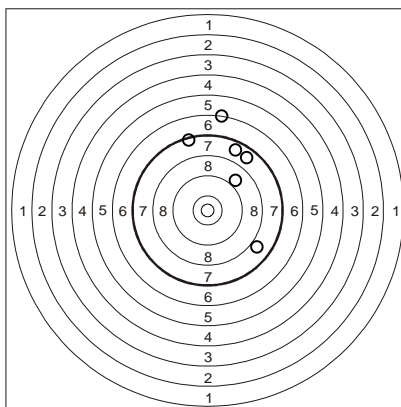

Heat 4			
	H	P	D
Tot	5/4/9	7,8	12,68
1	O	10,8	-
2	O	10,2	1,70
3	-	5,9	1,62
4	-	5,8	1,50
5	-	5,7	1,56
6	O	7,4	1,61
7	O	9,5	1,54
8	-	6,1	1,52
9	O	8,6	1,63

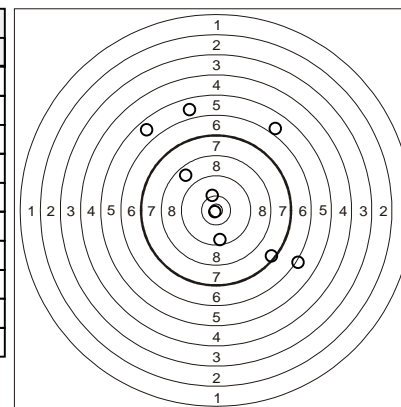

INDIVIDUAL SHOOTING RESULTS

POLISH INTERNATIONAL M.P. TROPHY & EUROPEAN U19 M.P. CUP - WOMEN'S HEAT 1

ZDRZENICKA Julia (POL)

Heat 1			
	H	P	D
Tot	5/11/16	6,0	32,43
1	-	2,2	-
2	-	5,7	2,27
3	-	2,5	2,11
4	-	6,0	2,12
5	O	9,7	2,12
6	-	6,4	1,91
7	O	7,5	2,02
8	-	3,0	2,06
9	O	9,0	2,03
10	-	6,9	1,87
11	O	7,5	1,99
12	-	5,8	1,98
13	-	1,4	2,03
14	-	6,1	4,06
15	-	6,8	1,97
16	O	8,8	1,89

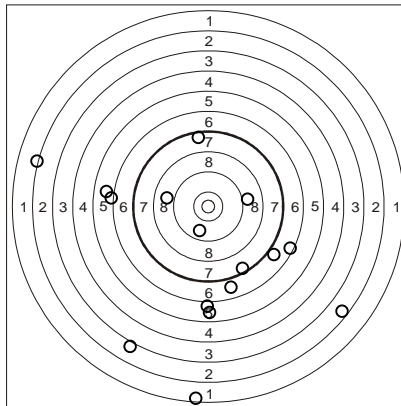

Heat 2			
	H	P	D
Tot	5/4/9	7,0	17,36
1	O	9,6	-
2	-	2,2	2,23
3	O	8,7	2,20
4	-	6,6	1,97
5	-	4,7	2,04
6	-	6,7	2,12
7	O	8,7	2,40
8	O	7,4	2,22
9	O	8,6	2,18

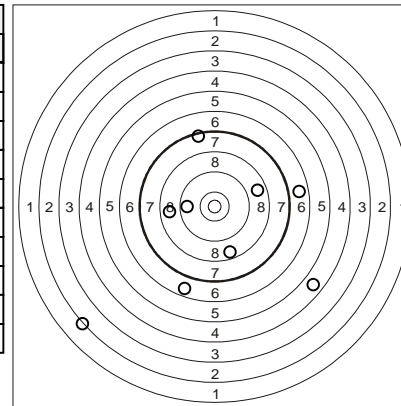

Heat 3			
	H	P	D
Tot	5/9/14	7,0	28,77
1	-	1,4	-
2	-	6,8	2,52
3	-	6,6	2,24
4	O	8,2	2,21
5	-	6,6	2,11
6	O	10,4	2,27
7	-	4,8	2,22
8	-	6,9	2,04
9	-	6,2	2,52
10	-	6,8	2,23
11	O	8,7	1,99
12	-	6,4	2,06
13	O	8,6	2,11
14	O	9,6	2,25

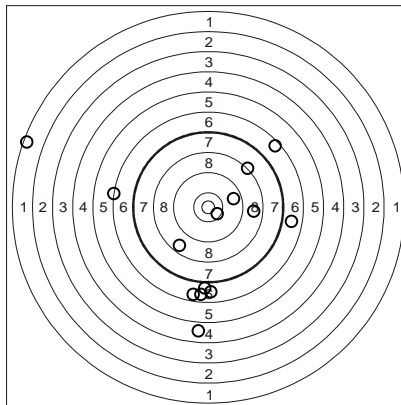

Heat 4			
	H	P	D
Tot	5/11/16	5,4	35,17
1	-	3,9	-
2	O	10,1	2,21
3	-	2,9	2,07
4	O	9,8	2,26
5	-	0,0	2,27
6	-	5,9	2,43
7	-	0,0	2,18
8	-	6,6	2,20
9	-	6,9	2,23
10	-	2,8	2,14
11	O	7,8	2,16
12	O	9,1	2,16
13	-	3,5	4,11
14	-	4,4	2,17
15	-	5,1	2,35
16	O	7,3	2,23

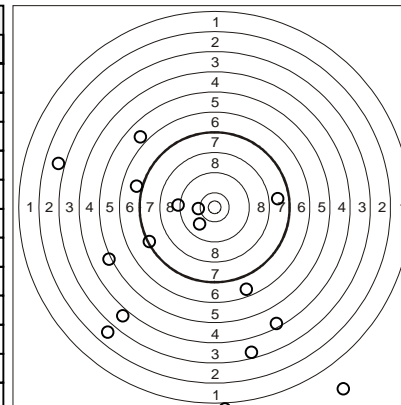

INDIVIDUAL SHOOTING RESULTS

POLISH INTERNATIONAL M.P. TROPHY & EUROPEAN U19 M.P. CUP - WOMEN'S HEAT 1

HLAVACKOVA Lucie (CZE)

Heat 1			
	H	P	D
Tot	5/1/6	8,1	10,56
1	O	7,7	-
2	O	7,4	2,32
3	-	6,1	2,12
4	O	10,4	1,88
5	O	9,2	1,95
6	O	7,9	2,29

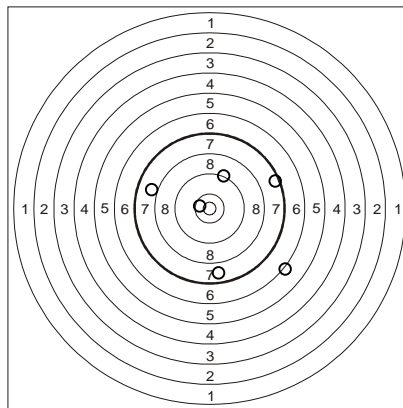

Heat 2			
	H	P	D
Tot	5/4/9	6,6	17,11
1	-	5,3	-
2	-	3,3	1,88
3	-	2,8	2,16
4	-	4,9	2,09
5	O	9,3	2,28
6	O	8,6	2,13
7	O	7,2	2,32
8	O	9,2	1,76
9	O	9,2	2,49

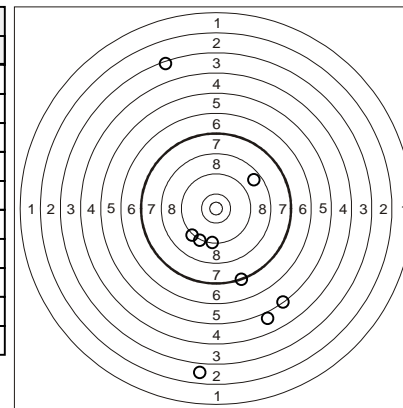

Heat 3			
	H	P	D
Tot	5/4/9	7,6	17,37
1	-	6,9	-
2	-	6,9	2,10
3	-	6,9	2,33
4	O	8,5	2,51
5	O	7,9	2,02
6	O	8,6	2,21
7	-	4,7	1,98
8	O	7,7	1,90
9	O	10,0	2,32

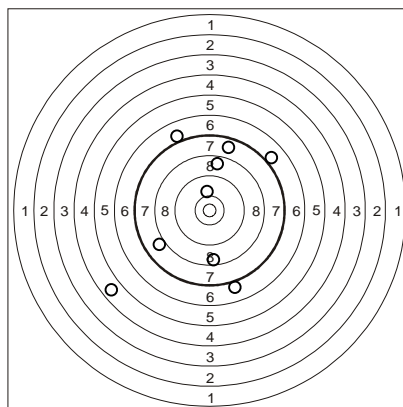

Heat 4			
	H	P	D
Tot	5/0/5	8,7	8,34
1	O	7,6	-
2	O	9,9	2,29
3	O	10,2	1,95
4	O	8,2	2,06
5	O	7,6	2,04

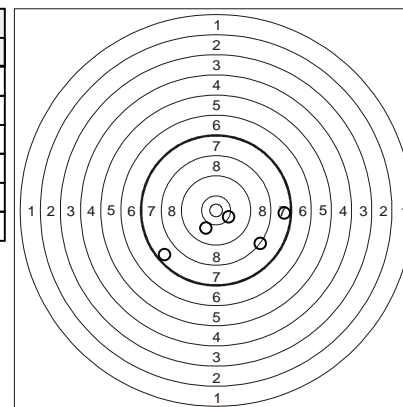

INDIVIDUAL SHOOTING RESULTS

POLISH INTERNATIONAL M.P. TROPHY & EUROPEAN U19 M.P. CUP - WOMEN'S HEAT 1

PAKINKYTE Teja (LTU)

Heat 1			
	H	P	D
Tot	5/2/7	7,1	12,08
1	O	7,5	-
2	-	3,7	2,03
3	-	6,4	2,03
4	O	8,9	2,10
5	O	7,4	1,96
6	O	7,3	2,04
7	O	8,4	1,92

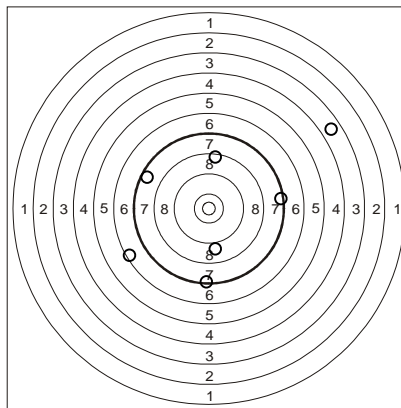

Heat 2			
	H	P	D
Tot	5/3/8	7,4	14,17
1	-	4,8	-
2	-	6,4	1,89
3	-	5,6	2,24
4	O	7,4	2,12
5	O	9,2	2,02
6	O	10,0	2,11
7	O	7,8	1,73
8	O	8,1	2,06

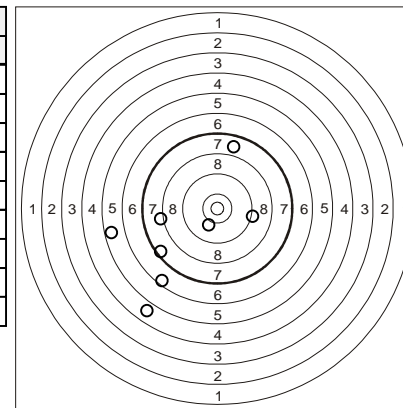

Heat 3			
	H	P	D
Tot	5/4/9	6,4	16,55
1	-	1,9	-
2	-	4,3	1,81
3	-	2,4	2,37
4	O	7,8	2,20
5	O	8,5	1,92
6	-	6,9	1,64
7	O	7,3	2,39
8	O	9,9	2,13
9	O	8,2	2,09

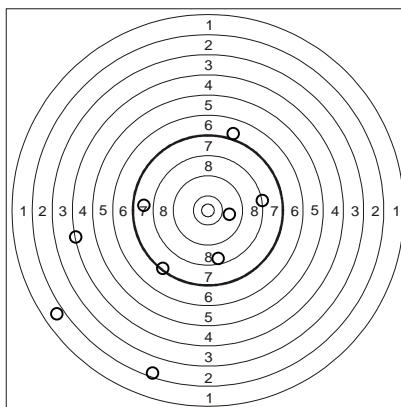

Heat 4			
	H	P	D
Tot	5/6/11	6,3	22,08
1	O	7,5	-
2	-	5,0	1,93
3	-	6,5	1,92
4	O	7,3	2,32
5	O	8,3	2,02
6	-	4,0	1,75
7	-	4,5	2,24
8	-	4,0	3,05
9	O	7,8	2,20
10	-	6,1	2,32
11	O	8,5	2,33

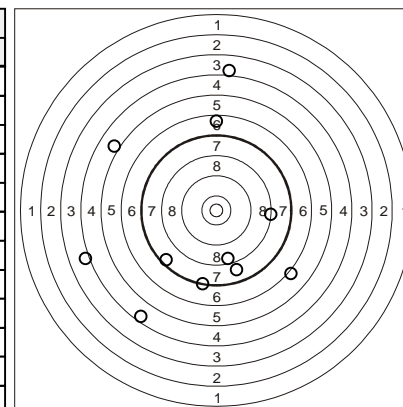

INDIVIDUAL SHOOTING RESULTS

POLISH INTERNATIONAL M.P. TROPHY & EUROPEAN U19 M.P. CUP - WOMEN'S HEAT 1

PRUSZYNSKA Wiktoria (POL)

Heat 1			
	H	P	D
Tot	5/2/7	8,0	11,04
1	-	5,2	-
2	0	8,5	2,02
3	0	9,9	1,72
4	0	8,7	1,90
5	-	5,6	1,65
6	0	7,6	1,96
7	0	10,2	1,79

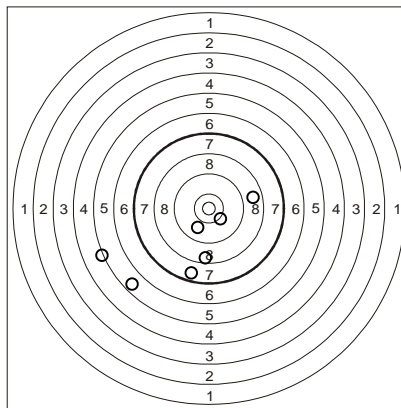

Heat 2			
	H	P	D
Tot	5/2/7	8,0	11,30
1	0	8,2	-
2	-	6,8	1,83
3	0	10,0	1,65
4	0	9,1	1,66
5	-	4,2	1,65
6	0	9,0	2,40
7	0	9,0	2,11

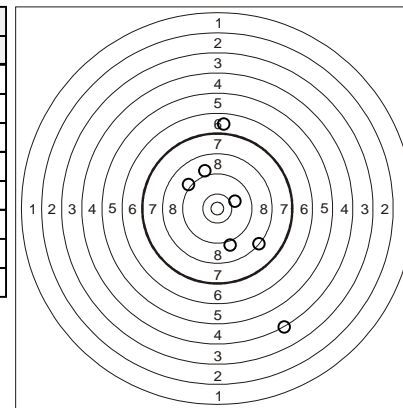

Heat 3			
	H	P	D
Tot	5/4/9	6,3	14,26
1	0	8,7	-
2	-	3,1	1,65
3	-	0,0	1,99
4	0	10,0	1,83
5	0	7,7	1,60
6	-	5,9	1,71
7	0	9,3	1,61
8	-	4,4	1,88
9	0	7,8	1,99

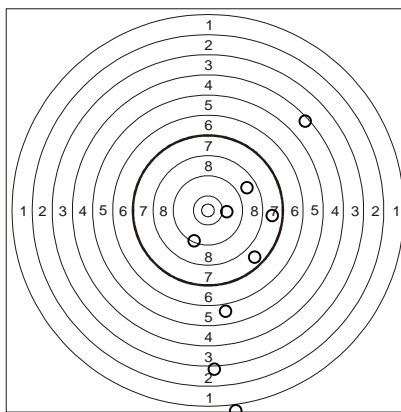

Heat 4			
	H	P	D
Tot	5/5/10	7,4	15,99
1	0	8,9	-
2	-	6,9	1,97
3	-	6,9	1,74
4	0	9,3	1,71
5	-	6,8	1,62
6	-	5,7	1,72
7	-	3,3	1,81
8	0	7,4	1,85
9	0	8,5	1,80
10	0	10,1	1,77

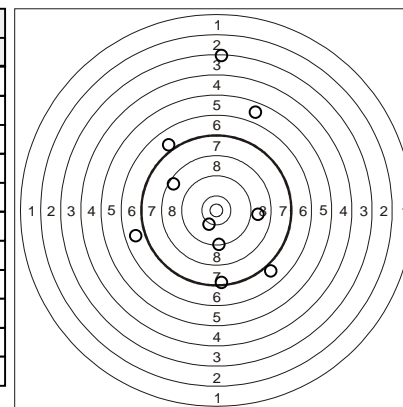

INDIVIDUAL SHOOTING RESULTS

POLISH INTERNATIONAL M.P. TROPHY & EUROPEAN U19 M.P. CUP - WOMEN'S HEAT 1

STUDENKOVA Anna (CZE)

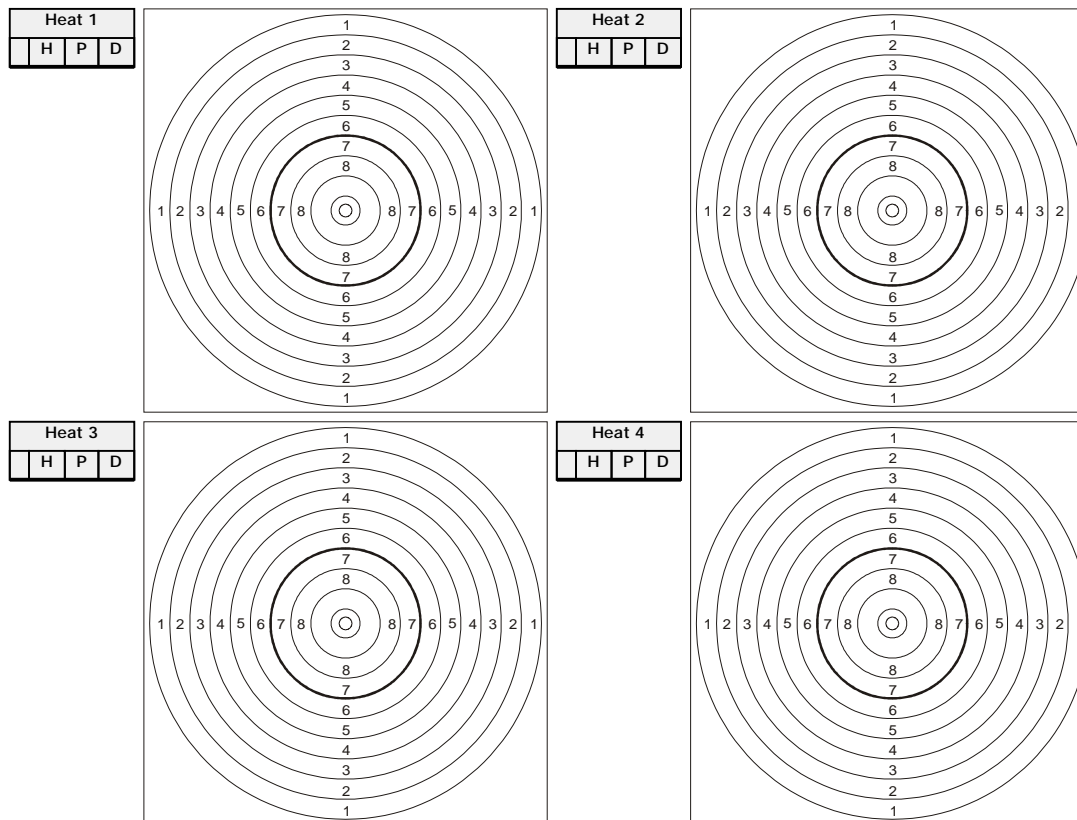

INDIVIDUAL SHOOTING RESULTS

POLISH INTERNATIONAL M.P. TROPHY & EUROPEAN U19 M.P. CUP - WOMEN'S HEAT 1

BIERNACKA Maja (POL)

Heat 1			
	H	P	D
Tot	5/3/8	8,2	17,37
1	O	10,2	-
2	-	6,9	2,99
3	-	6,0	2,37
4	O	8,5	2,31
5	O	8,8	2,61
6	O	8,8	2,38
7	-	5,8	2,44
8	O	10,3	2,27

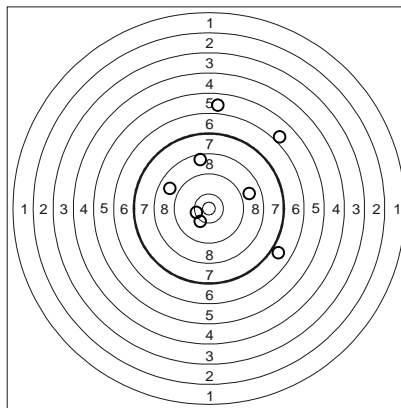

Heat 2			
	H	P	D
Tot	5/8/13	6,5	27,50
1	-	5,0	-
2	-	6,9	2,37
3	-	5,4	2,43
4	O	10,1	2,39
5	-	5,4	2,18
6	-	6,1	2,41
7	-	3,6	2,72
8	-	1,8	2,33
9	O	8,4	2,06
10	-	5,2	2,10
11	O	8,9	2,11
12	O	8,8	2,14
13	O	8,9	2,26

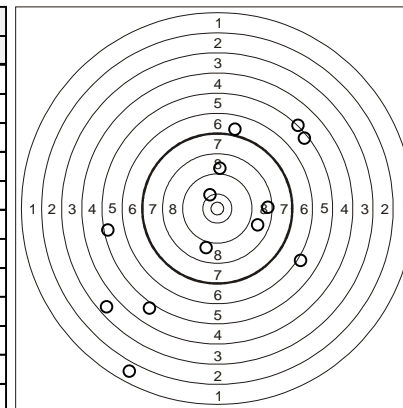

Heat 3			
	H	P	D
Tot	5/3/8	7,8	18,11
1	O	9,6	-
2	O	8,1	2,45
3	O	9,0	2,64
4	-	6,9	2,37
5	O	8,4	2,44
6	-	6,4	2,86
7	-	4,7	2,80
8	O	9,5	2,55

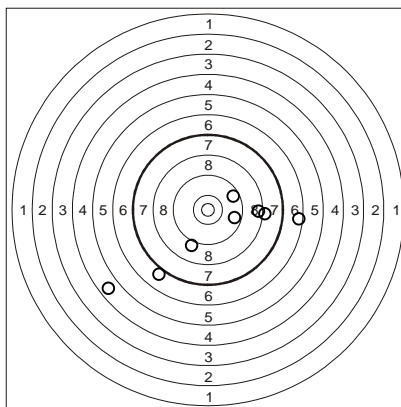

Heat 4			
	H	P	D
Tot	5/6/11	6,4	23,30
1	O	7,7	-
2	-	1,3	2,50
3	O	9,1	2,63
4	O	9,1	2,34
5	-	6,5	2,72
6	-	4,3	2,19
7	-	6,9	1,99
8	-	5,1	2,07
9	O	7,4	2,46
10	-	5,2	2,05
11	O	7,7	2,35

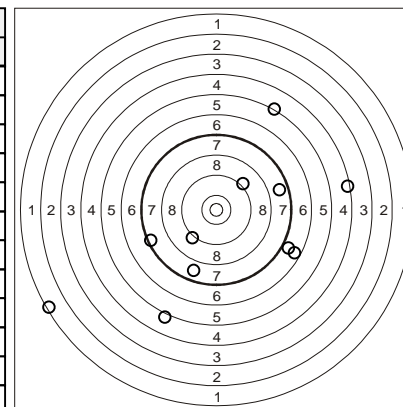

INDIVIDUAL SHOOTING RESULTS

POLISH INTERNATIONAL M.P. TROPHY & EUROPEAN U19 M.P. CUP - WOMEN'S HEAT 1

WOLSKA Pola (POL)

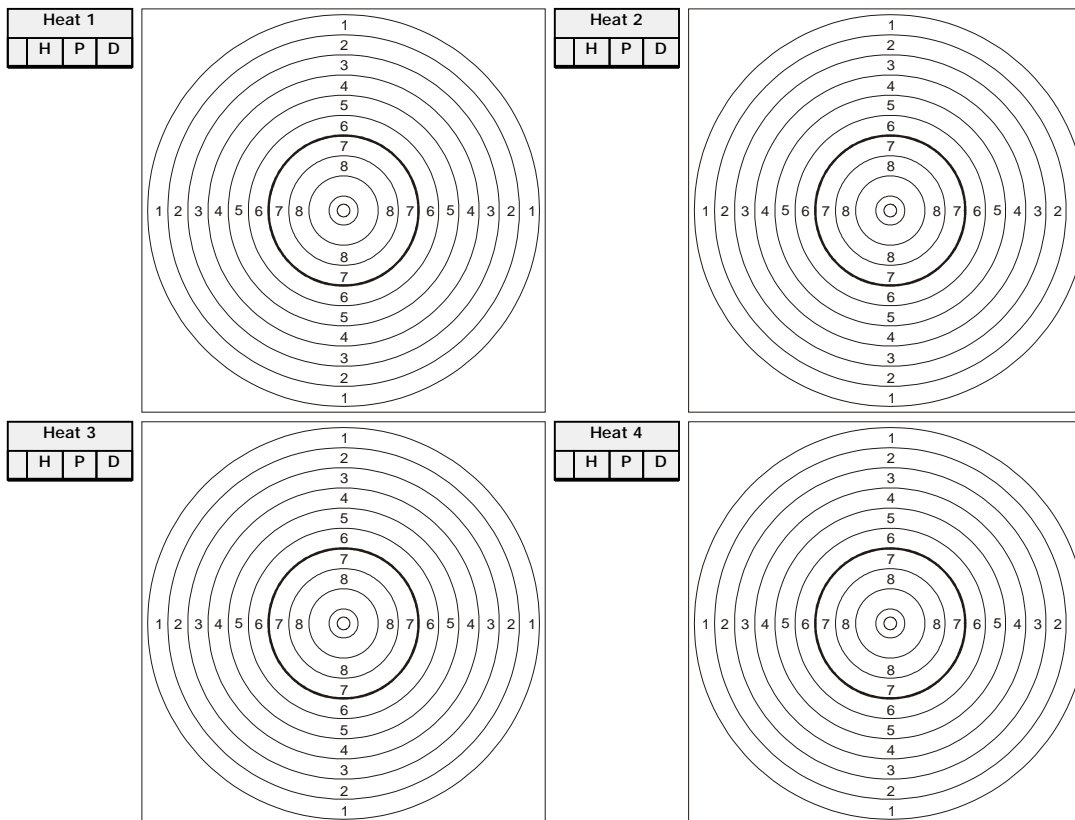

INDIVIDUAL SHOOTING RESULTS

POLISH INTERNATIONAL M.P. TROPHY & EUROPEAN U19 M.P. CUP - WOMEN'S HEAT 1

MRAZKOVA Stepanka (CZE)

Heat 1			
	H	P	D
Tot	5/1/6	8,5	10,99
1	O	9,4	-
2	O	8,1	2,28
3	-	6,9	2,05
4	O	9,2	2,22
5	O	8,7	2,02
6	O	8,4	2,42

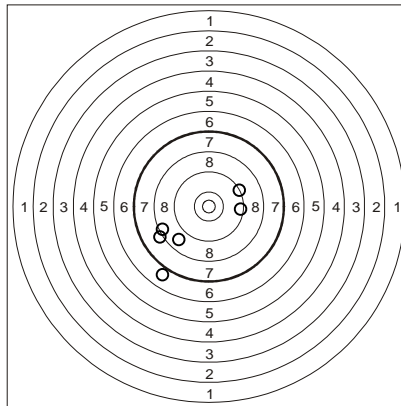

Heat 2			
	H	P	D
Tot	5/5/10	7,2	22,24
1	-	4,7	-
2	O	10,0	2,48
3	O	8,4	2,23
4	-	6,4	2,33
5	O	8,2	2,46
6	-	6,9	2,23
7	O	9,7	2,24
8	-	2,1	2,49
9	-	6,1	2,57
10	O	9,0	3,21

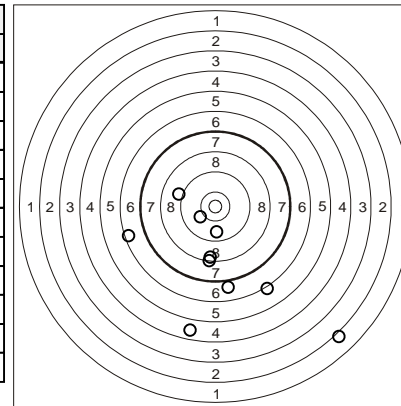

Heat 3			
	H	P	D
Tot	5/0/5	8,1	8,92
1	O	7,9	-
2	O	7,5	2,14
3	O	8,8	2,18
4	O	8,4	2,20
5	O	7,8	2,40

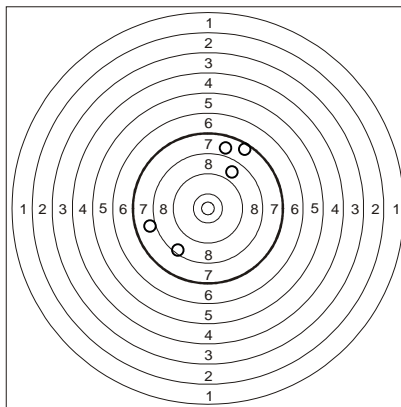

Heat 4			
	H	P	D
Tot	5/5/10	7,0	21,56
1	O	8,6	-
2	-	4,0	2,22
3	-	5,9	2,03
4	-	6,4	2,33
5	-	4,9	2,43
6	O	9,0	2,74
7	O	8,6	2,40
8	-	6,3	2,27
9	O	7,8	2,52
10	O	8,5	2,62

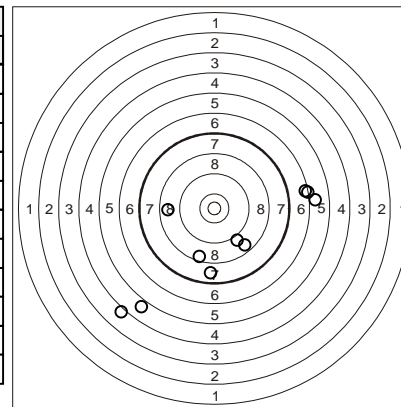

INDIVIDUAL SHOOTING RESULTS

POLISH INTERNATIONAL M.P. TROPHY & EUROPEAN U19 M.P. CUP - WOMEN'S HEAT 1

CIESIELSKA Zofia (POL)

Heat 1			
	H	P	D
Tot	5/5/10	7,0	18,47
1	-	4,5	-
2	-	6,9	1,76
3	O	9,1	1,82
4	-	5,9	1,83
5	-	4,3	2,52
6	O	7,8	1,92
7	O	8,5	1,65
8	-	6,9	1,83
9	O	8,3	1,91
10	O	7,6	3,23

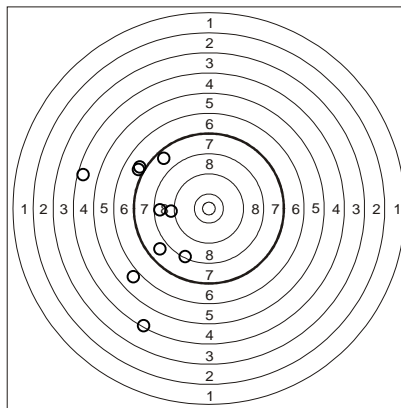

Heat 2			
	H	P	D
Tot	5/1/6	8,1	10,76
1	O	8,1	-
2	O	9,7	2,43
3	O	10,1	1,99
4	-	4,5	2,28
5	O	7,9	1,92
6	O	8,4	2,14

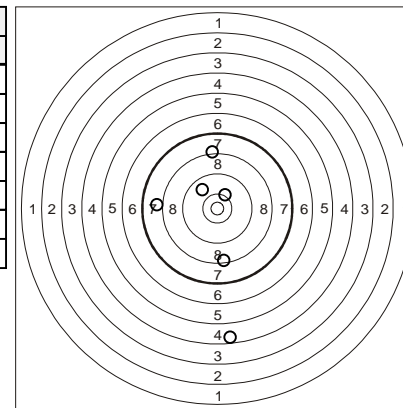

Heat 3			
	H	P	D
Tot	5/2/7	8,1	11,60
1	-	6,9	-
2	O	9,1	2,08
3	O	8,8	1,85
4	O	10,3	1,95
5	O	7,9	1,70
6	-	4,9	2,16
7	O	8,7	1,86

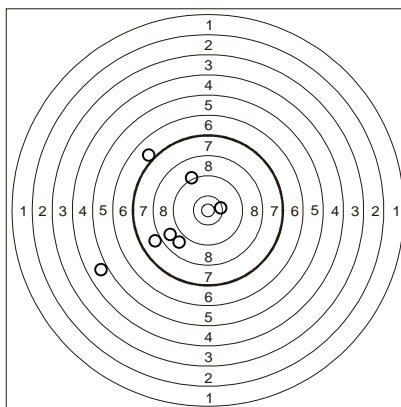

Heat 4			
	H	P	D
Tot	5/7/12	6,9	23,69
1	O	8,2	-
2	O	8,7	2,02
3	-	6,6	3,89
4	O	10,3	2,01
5	O	9,5	1,74
6	-	5,2	1,86
7	-	5,7	1,92
8	-	3,4	1,93
9	-	6,0	2,04
10	-	5,9	2,11
11	-	4,1	2,13
12	O	8,8	2,04

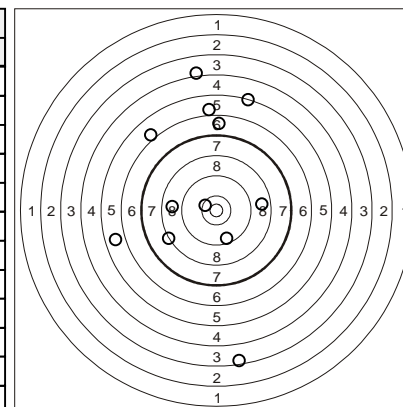

INDIVIDUAL SHOOTING RESULTS

POLISH INTERNATIONAL M.P. TROPHY & EUROPEAN U19 M.P. CUP - WOMEN'S HEAT 1

FUCIKOVA Marie (CZE)

Heat 1			
	H	P	D
Tot	5/4/9	7,2	13,45
1	O	7,6	-
2	-	6,1	1,60
3	O	8,1	1,75
4	-	3,9	1,77
5	-	6,8	1,83
6	-	6,9	1,63
7	O	8,1	1,63
8	O	9,3	1,59
9	O	8,2	1,65

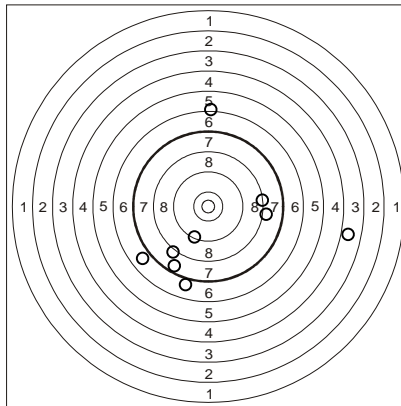

Heat 2			
	H	P	D
Tot	5/0/5	8,0	7,22
1	O	9,3	-
2	O	7,3	1,74
3	O	7,2	1,82
4	O	7,8	1,83
5	O	8,4	1,83

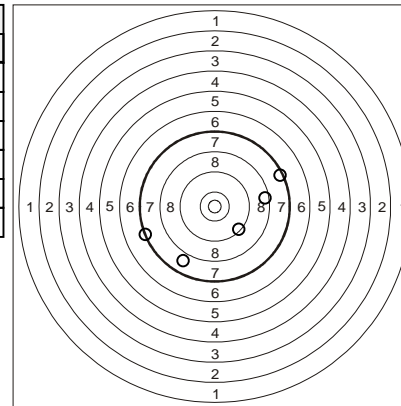

Heat 3			
	H	P	D
Tot	5/2/7	7,5	11,19
1	O	9,5	-
2	-	4,8	1,67
3	-	5,9	1,82
4	O	8,0	1,92
5	O	8,8	1,93
6	O	7,8	1,86
7	O	7,6	1,99

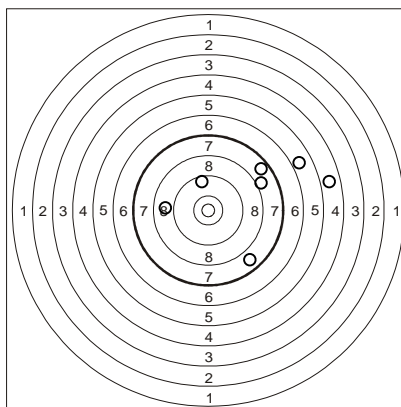

Heat 4			
	H	P	D
Tot	5/2/7	7,7	10,92
1	-	6,7	-
2	O	8,4	1,85
3	O	8,9	1,75
4	-	5,2	1,70
5	O	9,2	1,81
6	O	7,7	1,85
7	O	8,0	1,96

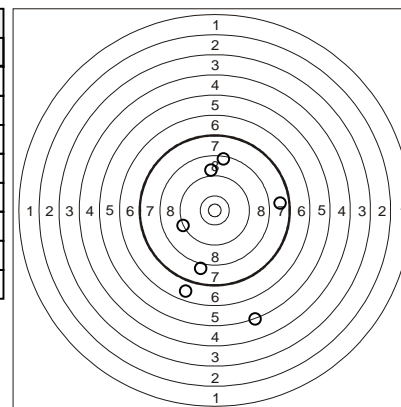

INDIVIDUAL SHOOTING RESULTS

POLISH INTERNATIONAL M.P. TROPHY & EUROPEAN U19 M.P. CUP - WOMEN'S HEAT 1

ANDREJEVAITE UIa (LTU)

Heat 1			
	H	P	D
Tot	5/3/8	7,4	14,02
1	O	9,2	-
2	O	9,8	1,93
3	O	7,2	1,94
4	O	8,6	1,94
5	-	6,3	2,00
6	-	2,6	2,15
7	-	6,9	2,03
8	O	8,6	2,03

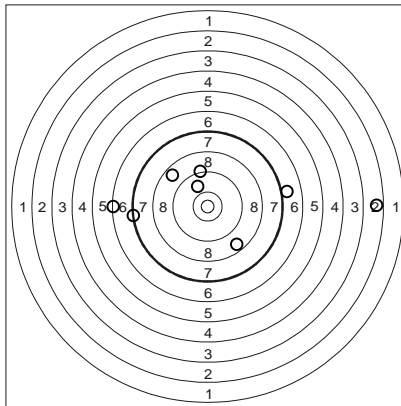

Heat 2			
	H	P	D
Tot	5/2/7	8,0	12,40
1	-	6,1	-
2	O	9,1	2,14
3	O	8,7	1,93
4	O	8,2	2,11
5	-	6,9	2,11
6	O	8,0	2,02
7	O	9,1	2,09

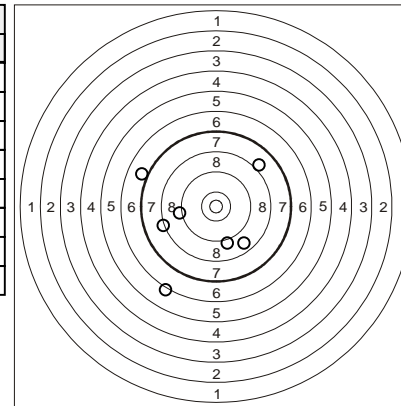

Heat 3			
	H	P	D
Tot	5/4/9	7,5	17,11
1	O	7,6	-
2	-	6,9	2,22
3	-	6,9	2,24
4	O	9,6	2,21
5	O	7,2	2,23
6	-	5,9	2,05
7	-	5,7	1,99
8	O	7,9	2,02
9	O	9,7	2,15

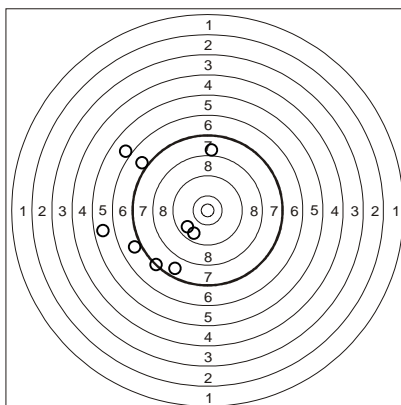

Heat 4			
	H	P	D
Tot	5/7/12	7,1	22,13
1	-	6,9	-
2	O	8,5	2,11
3	-	6,0	1,98
4	O	8,6	1,93
5	O	8,3	2,03
6	-	5,8	1,92
7	-	6,9	1,90
8	O	8,7	1,93
9	-	6,9	2,13
10	-	6,8	1,99
11	-	3,3	1,97
12	O	8,3	2,24

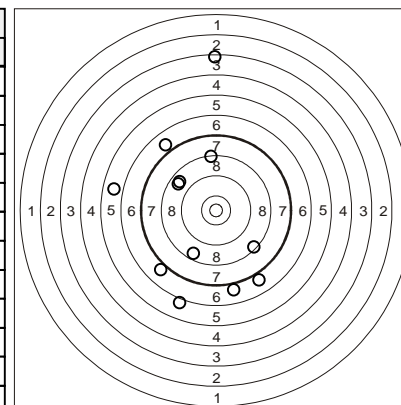

INDIVIDUAL SHOOTING RESULTS

POLISH INTERNATIONAL M.P. TROPHY & EUROPEAN U19 M.P. CUP - WOMEN'S HEAT 1

RUTKOWSKA Maja (POL)

Heat 1			
	H	P	D
Tot	5/2/7	7,9	12,63
1	-	5,8	-
2	O	8,3	1,97
3	O	7,7	2,10
4	O	9,6	2,14
5	-	6,9	2,03
6	O	7,8	2,11
7	O	9,5	2,28

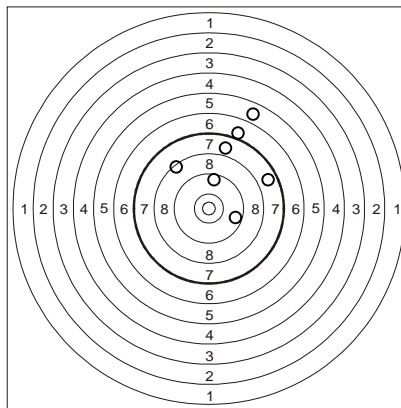

Heat 2			
	H	P	D
Tot	5/4/9	7,0	16,02
1	-	4,2	-
2	-	5,5	2,01
3	-	4,5	2,01
4	O	10,0	2,15
5	O	8,6	1,90
6	-	3,7	2,00
7	O	9,2	1,95
8	O	9,1	1,93
9	O	8,0	2,07

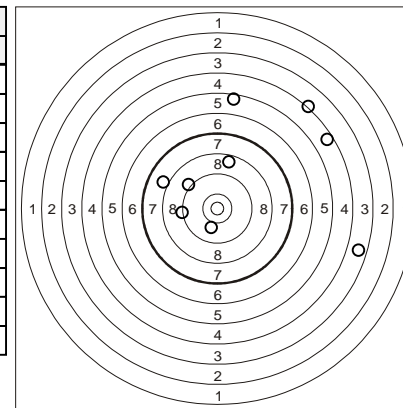

Heat 3			
	H	P	D
Tot	5/2/7	8,5	12,45
1	O	9,6	-
2	-	5,0	2,01
3	O	10,3	2,04
4	O	10,0	1,99
5	O	8,4	1,98
6	-	5,7	2,23
7	O	10,7	2,20

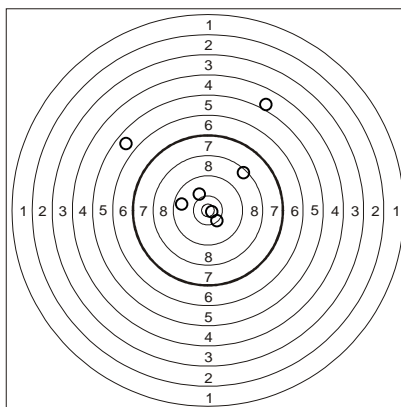

Heat 4			
	H	P	D
Tot	5/8/13	7,0	26,55
1	-	6,9	-
2	-	6,5	2,13
3	-	6,9	2,29
4	-	4,5	2,14
5	-	4,6	2,13
6	O	8,0	2,36
7	-	4,8	2,01
8	-	6,7	2,23
9	O	8,5	2,15
10	-	5,7	2,26
11	O	9,9	2,27
12	O	9,4	2,29
13	O	8,7	2,29

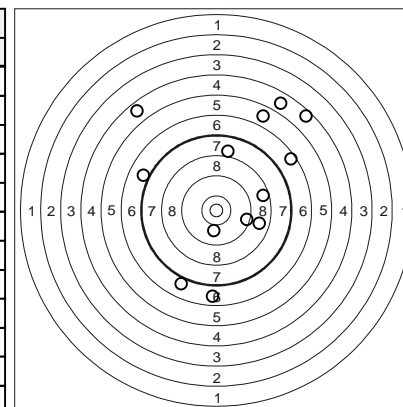

INDIVIDUAL SHOOTING RESULTS

POLISH INTERNATIONAL M.P. TROPHY & EUROPEAN U19 M.P. CUP - WOMEN'S HEAT 1

PETERA Patrycja (POL)

Heat 1			
	H	P	D
Tot	5/4/9	6,5	25,49
1	O	7,5	-
2	-	0,0	2,34
3	-	6,9	3,21
4	-	6,9	7,20
5	-	5,0	3,09
6	O	7,3	1,98
7	O	7,8	2,27
8	O	9,3	3,24
9	O	7,4	2,16

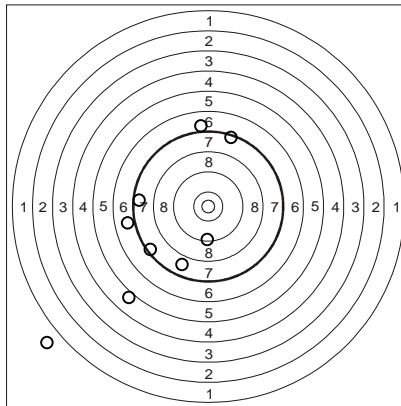

Heat 2			
	H	P	D
Tot	5/4/9	7,4	27,07
1	-	6,4	-
2	O	9,7	2,35
3	O	7,6	5,68
4	O	8,8	4,56
5	-	4,1	4,43
6	-	6,9	2,44
7	-	6,9	2,84
8	O	7,6	2,52
9	O	8,2	2,25

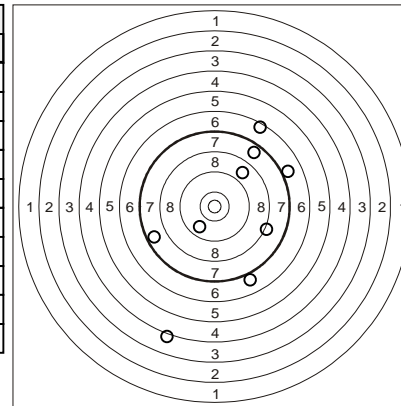

Heat 3			
	H	P	D
Tot	2/6/8	5,1	50,00
1	-	6,9	-
2	O	8,6	2,25
3	-	4,1	2,64
4	-	3,9	8,49
5	-	1,4	2,72
6	-	2,1	16,04
7	-	4,9	3,32
8	O	8,9	2,74

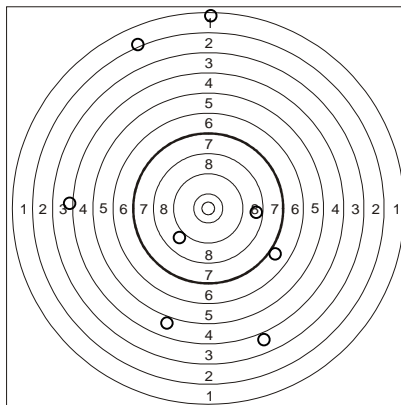

Heat 4			
	H	P	D
Tot	5/12/17	6,1	42,91
1	-	6,9	-
2	-	3,7	2,62
3	O	10,1	2,36
4	-	5,9	2,72
5	-	6,7	2,12
6	-	1,3	3,04
7	-	6,5	2,64
8	O	7,9	2,67
9	O	8,1	2,53
10	-	6,2	3,00
11	-	4,5	2,47
12	-	6,4	2,81
13	-	2,4	2,66
14	-	6,1	2,65
15	-	4,6	2,54
16	O	7,7	2,43
17	O	8,2	3,65

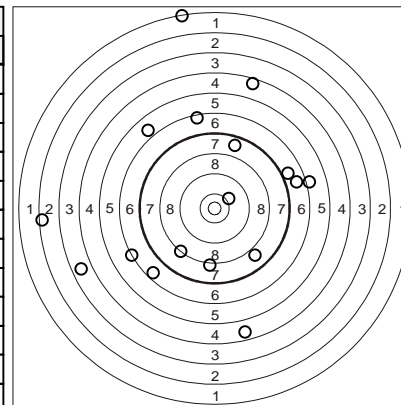

INDIVIDUAL SHOOTING RESULTS

POLISH INTERNATIONAL M.P. TROPHY & EUROPEAN U19 M.P. CUP - WOMEN'S HEAT 1

SZMYTKE Karolina (POL)

Heat 1			
	H	P	D
Tot	5/1/6	8,4	14,93
1	O	10,0	-
2	O	8,7	3,06
3	-	2,7	2,86
4	O	9,5	3,12
5	O	10,6	3,00
6	O	8,9	2,89

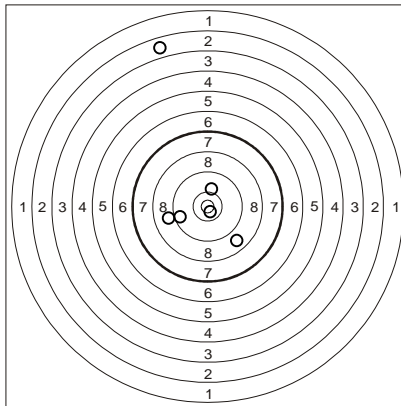

Heat 2			
	H	P	D
Tot	5/3/8	8,0	21,08
1	O	9,3	-
2	O	8,7	2,98
3	-	6,9	2,71
4	O	9,8	2,63
5	-	4,6	3,42
6	-	6,7	2,95
7	O	8,7	3,37
8	O	9,4	3,02

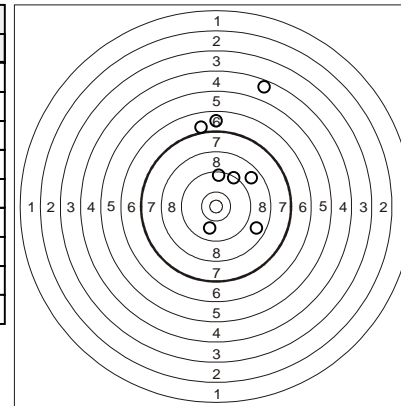

Heat 3			
	H	P	D
Tot	5/3/8	7,4	23,09
1	O	8,3	-
2	O	8,7	3,41
3	O	7,9	2,90
4	O	8,2	3,01
5	-	6,4	3,15
6	-	4,4	3,76
7	-	6,1	3,33
8	O	9,3	3,53

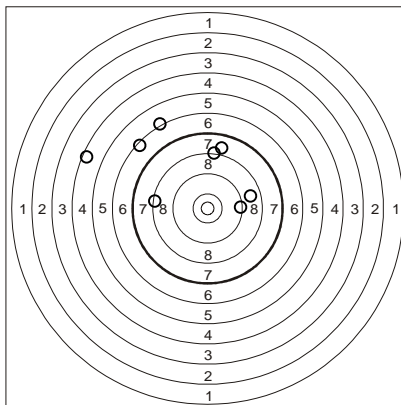

Heat 4			
	H	P	D
Tot	5/3/8	7,8	23,54
1	O	9,6	-
2	O	7,4	3,62
3	O	8,1	3,22
4	-	6,9	3,29
5	-	6,6	3,24
6	O	8,0	3,07
7	-	6,9	3,03
8	O	9,2	4,07

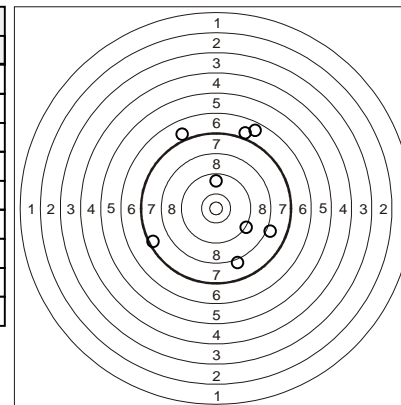

INDIVIDUAL SHOOTING RESULTS

POLISH INTERNATIONAL M.P. TROPHY & EUROPEAN U19 M.P. CUP - WOMEN'S HEAT 1

PITRMANOVA Katrina (CZE)

Heat 1			
	H	P	D
Tot	5/1/6	7,8	12,50
1	-	5,5	-
2	O	8,3	2,83
3	O	7,8	2,51
4	O	8,5	2,31
5	O	9,2	2,33
6	O	7,4	2,52

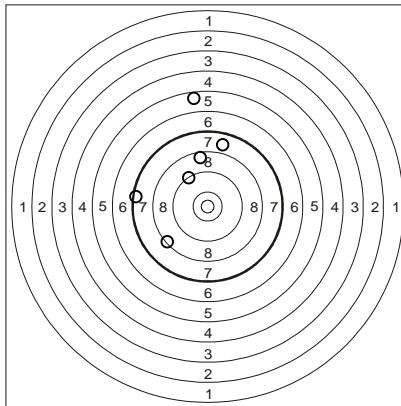

Heat 2			
	H	P	D
Tot	5/0/5	8,9	9,98
1	O	8,9	-
2	O	9,6	2,52
3	O	9,0	2,21
4	O	7,7	2,53
5	O	9,3	2,72

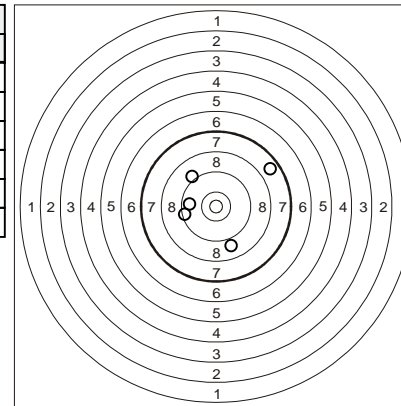

Heat 3			
	H	P	D
Tot	5/2/7	8,1	14,48
1	O	8,4	-
2	-	6,2	2,36
3	-	5,8	2,59
4	O	9,1	2,41
5	O	8,5	2,33
6	O	9,4	2,34
7	O	9,0	2,45

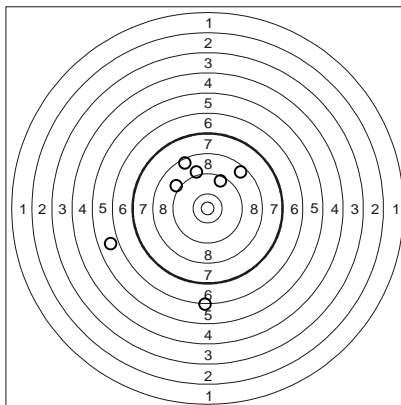

Heat 4			
	H	P	D
Tot	5/0/5	8,8	10,47
1	O	10,1	-
2	O	8,7	2,58
3	O	8,4	2,84
4	O	8,3	2,40
5	O	8,5	2,65

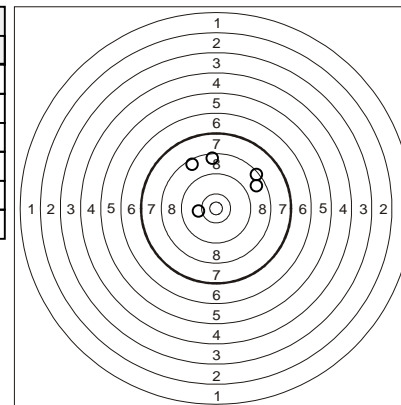

INDIVIDUAL SHOOTING RESULTS

POLISH INTERNATIONAL M.P. TROPHY & EUROPEAN U19 M.P. CUP - WOMEN'S HEAT 1

DOLEZALKOVA Viktorie (CZE)

Heat 1			
	H	P	D
Tot	5/5/10	7,3	22,32
1	-	5,4	-
2	O	9,1	2,34
3	-	5,5	2,21
4	O	10,2	2,23
5	O	8,8	2,66
6	-	4,9	2,24
7	O	9,7	2,11
8	-	5,3	4,31
9	-	6,4	2,13
10	O	7,5	2,09

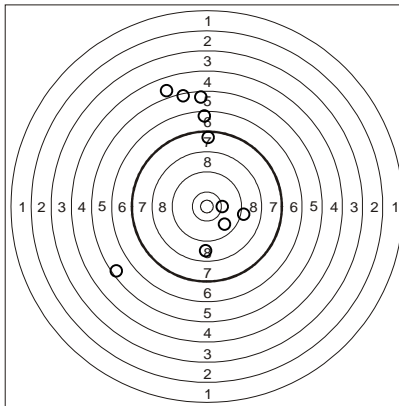

Heat 2			
	H	P	D
Tot	5/5/10	7,3	21,24
1	O	10,2	-
2	-	6,7	2,33
3	-	5,8	2,21
4	-	6,4	2,24
5	O	7,6	2,14
6	-	2,0	2,89
7	O	9,0	2,76
8	O	9,5	2,40
9	-	6,2	2,13
10	O	9,1	2,14

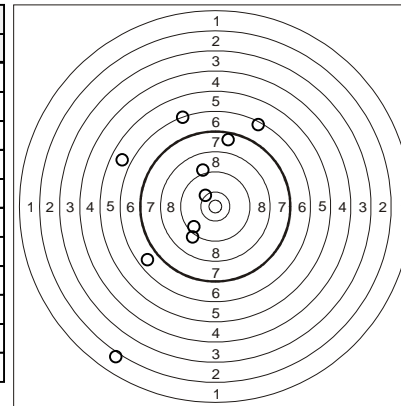

Heat 3			
	H	P	D
Tot	5/1/6	7,6	11,08
1	O	8,1	-
2	O	7,5	2,23
3	O	7,4	2,32
4	O	8,7	2,15
5	-	6,3	2,20
6	O	7,6	2,18

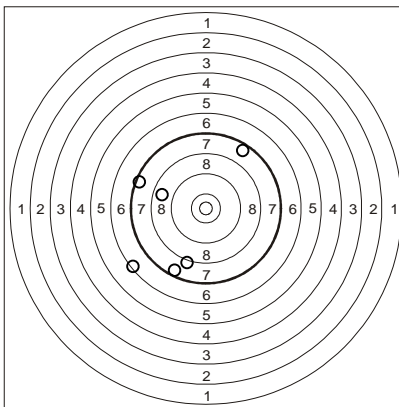

Heat 4			
	H	P	D
Tot	5/4/9	7,5	17,78
1	-	2,6	-
2	O	9,3	2,17
3	-	6,9	2,10
4	O	9,1	2,31
5	-	6,8	2,13
6	-	5,7	2,04
7	O	8,8	2,17
8	O	9,1	2,80
9	O	8,9	2,06

