

INDIVIDUAL SHOOTING RESULTS

POLISH INTERNATIONAL M.P. TROPHY & EUROPEAN U19 M.P. CUP - MEN HEAT 1

OLEJNIK Filip (POL)

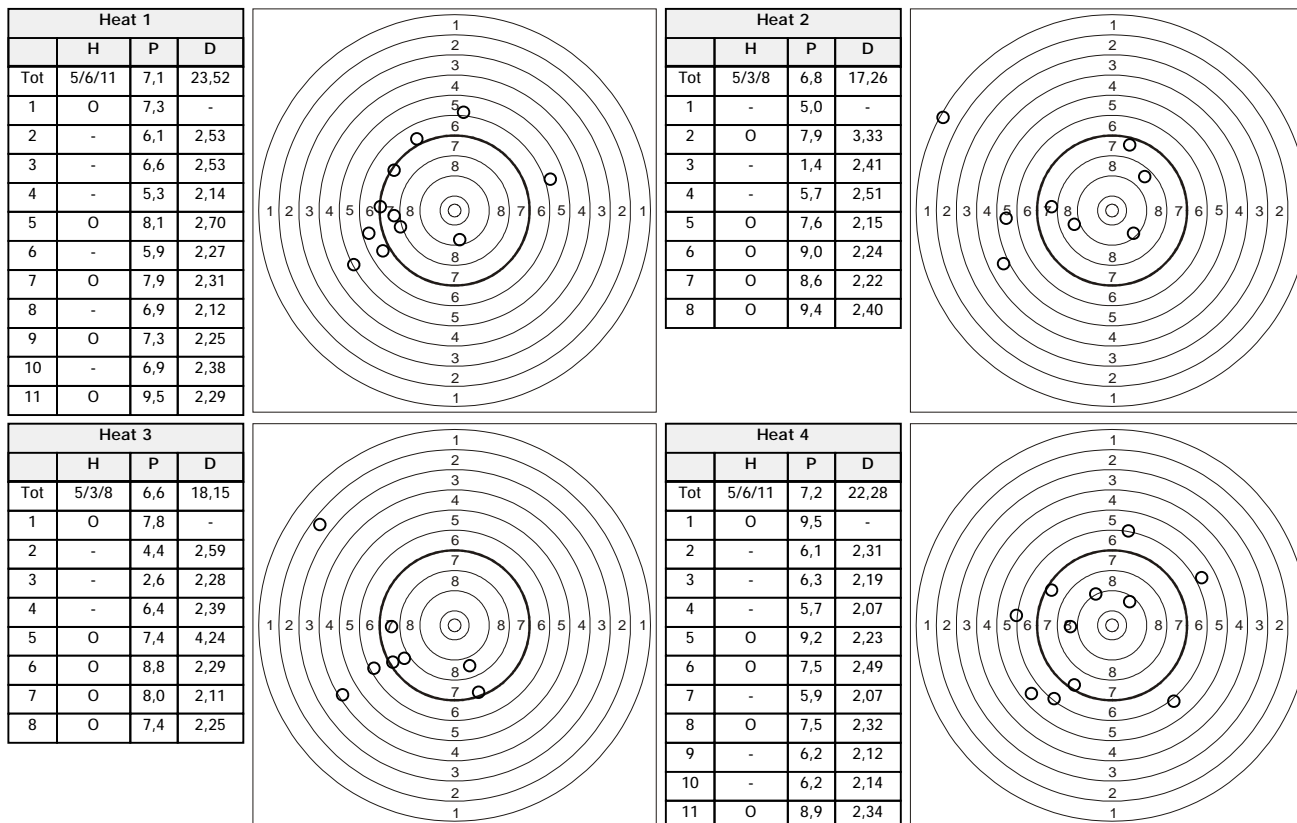

INDIVIDUAL SHOOTING RESULTS

POLISH INTERNATIONAL M.P. TROPHY & EUROPEAN U19 M.P. CUP - MEN HEAT 1

JASIULEVICIUS Dzastinas (LTU)

Heat 1			
	H	P	D
Tot	5/8/13	7,2	23,16
1	-	5,9	-
2	-	6,8	2,00
3	-	5,1	2,05
4	O	10,2	2,13
5	-	6,1	2,02
6	-	6,9	1,79
7	-	5,7	1,83
8	O	9,0	1,95
9	-	6,0	1,89
10	O	8,8	1,90
11	O	7,4	1,82
12	-	6,8	1,92
13	O	8,5	1,86

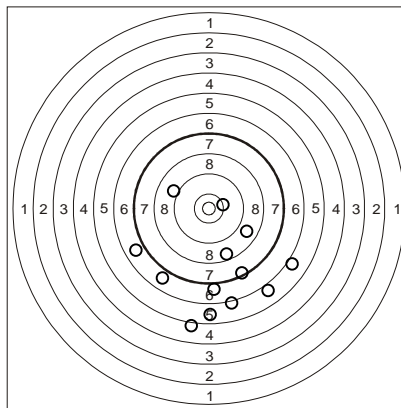

Heat 2			
	H	P	D
Tot	5/4/9	7,5	16,77
1	O	8,9	-
2	O	10,2	3,82
3	-	5,0	1,76
4	-	4,6	1,71
5	-	5,1	1,78
6	-	6,2	1,76
7	O	10,3	2,19
8	O	8,3	1,88
9	O	8,8	1,87

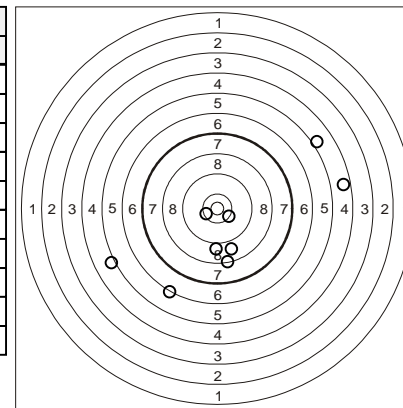

Heat 3			
	H	P	D
Tot	5/4/9	6,6	14,62
1	-	4,8	-
2	O	7,9	1,88
3	-	4,0	1,95
4	-	4,5	1,69
5	O	7,9	1,83
6	-	5,8	1,71
7	O	7,2	1,73
8	O	8,4	1,91
9	O	8,8	1,92

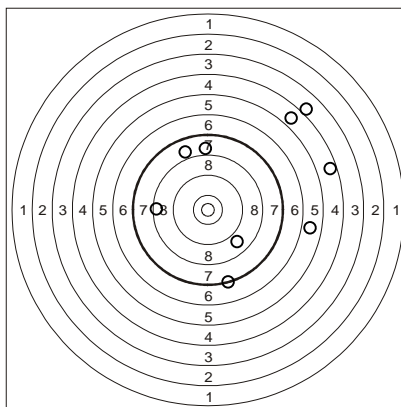

Heat 4			
	H	P	D
Tot	5/4/9	7,8	14,92
1	O	10,0	-
2	-	4,1	2,02
3	O	9,0	1,82
4	-	6,8	1,90
5	-	6,9	1,93
6	O	9,7	1,89
7	-	4,2	1,72
8	O	9,5	1,76
9	O	10,2	1,88

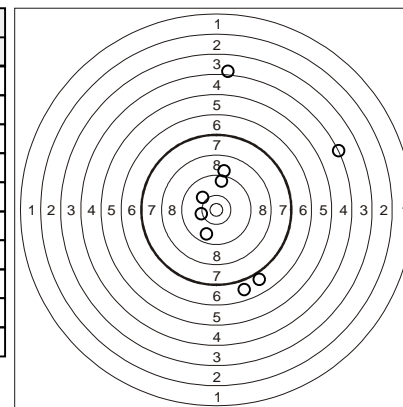

INDIVIDUAL SHOOTING RESULTS

POLISH INTERNATIONAL M.P. TROPHY & EUROPEAN U19 M.P. CUP - MEN HEAT 1

MUELLER Vital (SUI)

Heat 1			
	H	P	D
Tot	5/1/6	8,0	12,44
1	O	8,4	-
2	-	6,3	2,57
3	O	7,5	2,50
4	O	8,4	2,32
5	O	9,4	2,43
6	O	7,7	2,62

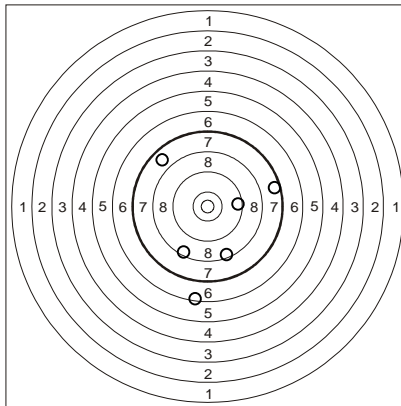

Heat 2			
	H	P	D
Tot	5/3/8	7,9	17,04
1	-	6,5	-
2	O	9,5	2,41
3	O	9,5	2,49
4	-	4,9	2,36
5	O	9,3	2,49
6	O	9,9	2,52
7	-	6,3	2,41
8	O	7,3	2,36

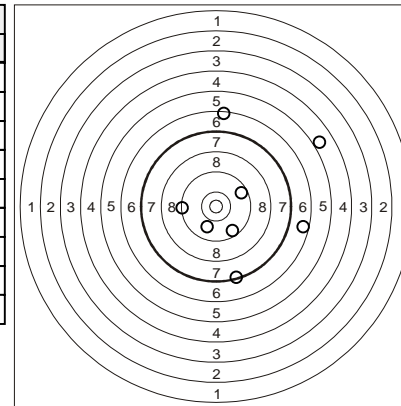

Heat 3			
	H	P	D
Tot	5/3/8	7,8	17,19
1	-	5,0	-
2	O	10,6	2,52
3	O	9,1	2,48
4	O	7,7	2,37
5	-	5,0	2,47
6	-	6,9	2,49
7	O	9,7	2,53
8	O	8,7	2,33

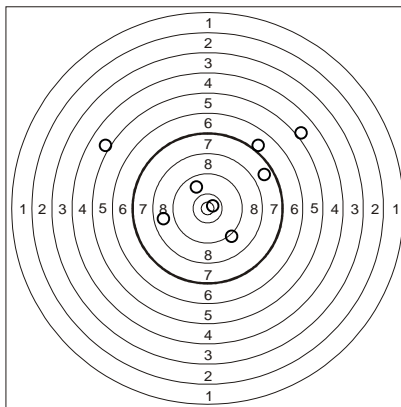

Heat 4			
	H	P	D
Tot	5/0/5	9,1	10,11
1	O	8,1	-
2	O	9,2	2,62
3	O	10,2	2,44
4	O	9,0	2,54
5	O	8,8	2,51

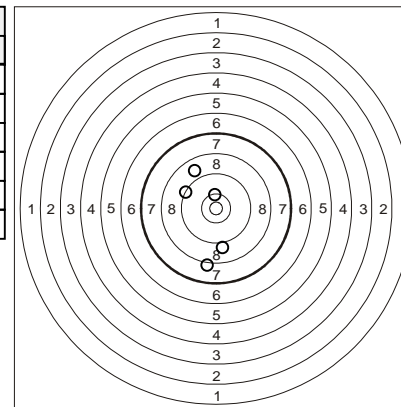

INDIVIDUAL SHOOTING RESULTS

POLISH INTERNATIONAL M.P. TROPHY & EUROPEAN U19 M.P. CUP - MEN HEAT 1

PARIZEK Tobias (CZE)

Heat 1			
	H	P	D
Tot	5/3/8	8,1	12,32
1	O	9,6	-
2	O	9,3	1,75
3	O	9,5	1,63
4	O	9,5	1,67
5	-	6,0	1,76
6	-	6,9	1,82
7	-	4,1	1,84
8	O	9,5	1,85

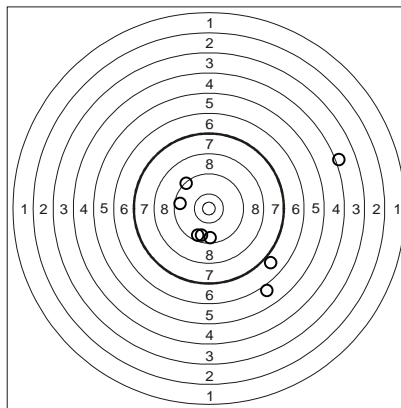

Heat 2			
	H	P	D
Tot	5/5/10	7,0	15,11
1	-	6,7	-
2	-	3,5	1,82
3	O	10,1	1,73
4	O	9,0	1,59
5	O	8,0	1,64
6	O	7,9	1,54
7	-	6,6	1,74
8	-	3,4	1,63
9	-	4,4	1,71
10	O	9,9	1,71

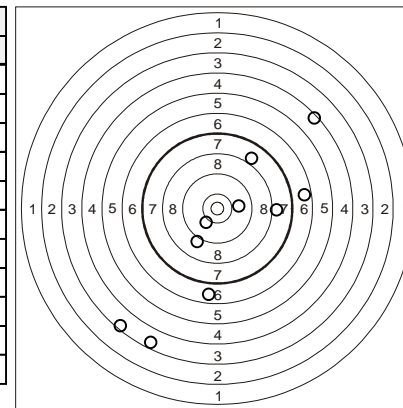

Heat 3			
	H	P	D
Tot	5/1/6	8,1	8,44
1	-	5,6	-
2	O	10,0	1,72
3	O	8,0	1,72
4	O	8,5	1,98
5	O	9,1	1,55
6	O	7,5	1,47

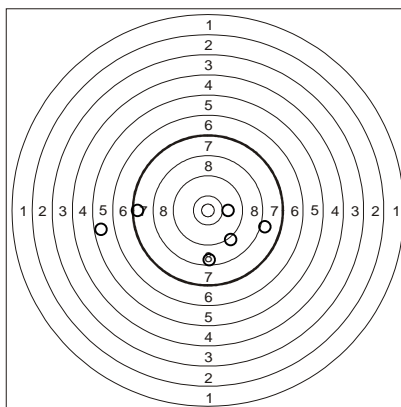

Heat 4			
	H	P	D
Tot	5/4/9	6,9	17,05
1	O	8,4	-
2	O	7,7	1,71
3	-	5,2	1,55
4	-	5,3	1,61
5	O	8,0	1,57
6	O	9,0	3,73
7	-	3,4	1,49
8	-	6,8	3,77
9	O	8,4	1,62

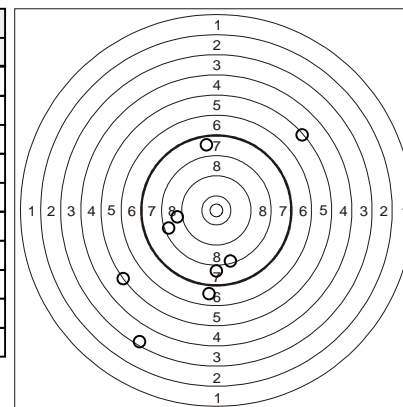

INDIVIDUAL SHOOTING RESULTS

POLISH INTERNATIONAL M.P. TROPHY & EUROPEAN U19 M.P. CUP - MEN HEAT 1

JABLONSKI Michal (POL)

Heat 1			
	H	P	D
Tot	5/8/13	6,7	21,12
1	O	8,4	-
2	-	6,1	1,60
3	-	6,0	2,09
4	-	5,2	1,83
5	-	5,8	1,81
6	O	9,0	1,76
7	-	4,0	1,66
8	-	6,1	1,65
9	-	4,4	1,83
10	O	8,1	1,69
11	O	8,8	1,70
12	-	6,5	1,72
13	O	8,6	1,78

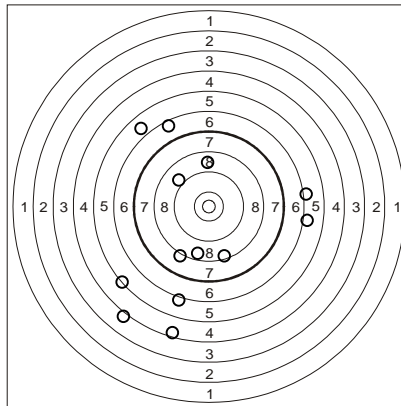

Heat 2			
	H	P	D
Tot	5/8/13	5,9	20,00
1	-	4,7	-
2	-	0,0	1,83
3	-	5,5	1,79
4	O	8,1	1,84
5	-	6,6	1,72
6	-	4,3	1,69
7	O	10,3	1,64
8	-	4,7	1,57
9	O	9,0	1,47
10	-	1,2	1,66
11	-	4,5	1,64
12	O	9,7	1,65
13	O	7,6	1,50

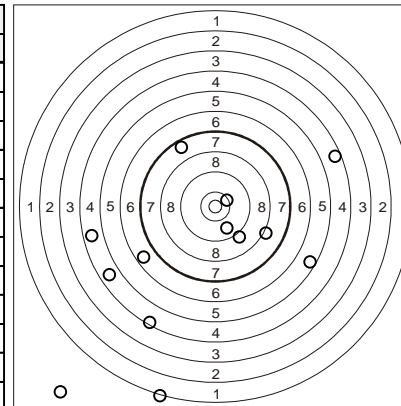

Heat 3			
	H	P	D
Tot	5/4/9	7,1	13,58
1	O	7,4	-
2	-	6,3	1,70
3	O	10,5	1,74
4	O	8,4	1,34
5	-	1,9	1,76
6	O	8,6	1,63
7	-	6,8	1,75
8	-	6,1	1,97
9	O	7,7	1,69

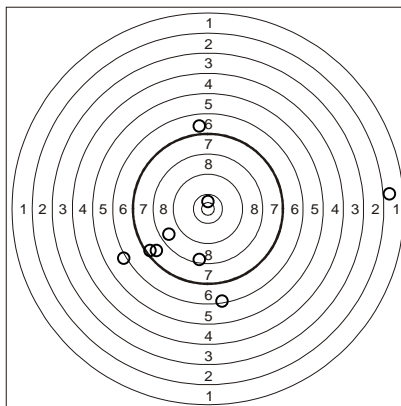

Heat 4			
	H	P	D
Tot	5/5/10	7,3	14,56
1	-	6,3	-
2	O	9,7	1,76
3	-	6,9	1,61
4	O	8,7	1,68
5	-	4,8	1,55
6	-	2,6	1,34
7	-	6,2	1,65
8	O	10,5	1,67
9	O	7,7	1,66
10	O	9,7	1,64

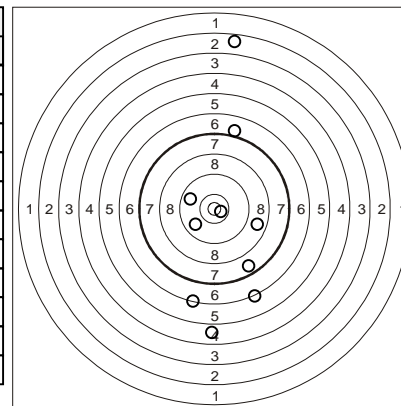

INDIVIDUAL SHOOTING RESULTS

POLISH INTERNATIONAL M.P. TROPHY & EUROPEAN U19 M.P. CUP - MEN HEAT 1

RYSKA Jonas (CZE)

Heat 1			
	H	P	D
Tot	5/10/15	6,3	37,98
1	-	2,3	-
2	-	6,7	2,37
3	-	3,3	3,00
4	O	9,7	2,46
5	-	3,9	2,47
6	-	4,6	2,78
7	-	6,9	2,46
8	O	10,2	2,56
9	-	3,3	3,05
10	O	7,6	2,79
11	-	4,7	2,87
12	-	6,9	2,40
13	O	9,6	2,80
14	-	6,8	2,74
15	O	8,7	3,23

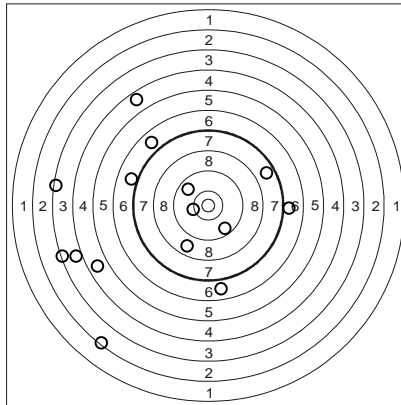

Heat 2			
	H	P	D
Tot	5/4/9	8,0	20,23
1	O	9,3	-
2	O	8,4	2,42
3	O	9,7	2,44
4	-	5,9	2,35
5	-	6,0	2,39
6	-	5,7	2,45
7	-	6,1	2,60
8	O	10,7	2,96
9	O	10,0	2,62

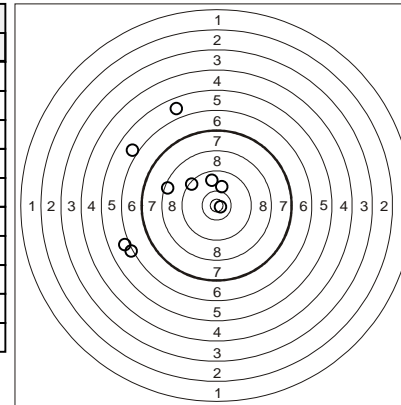

Heat 3			
	H	P	D
Tot	5/8/13	6,3	34,53
1	O	7,7	-
2	-	0,0	2,89
3	-	5,8	2,95
4	O	7,9	2,90
5	O	9,9	2,52
6	-	5,4	2,74
7	-	5,6	2,66
8	-	6,7	2,59
9	-	2,0	2,58
10	-	6,3	2,68
11	O	9,4	3,35
12	-	6,6	3,19
13	O	8,0	3,48

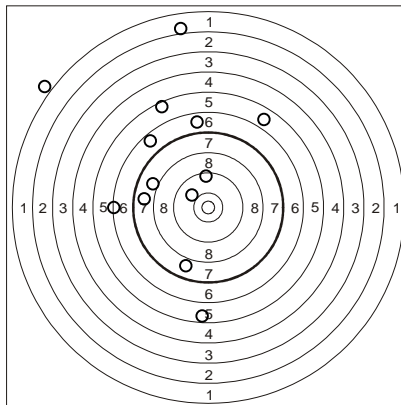

Heat 4			
	H	P	D
Tot	3/12/15	5,7	49,99
1	-	5,0	-
2	-	6,1	2,98
3	-	3,7	2,61
4	-	6,1	2,82
5	-	1,8	3,17
6	-	6,1	3,41
7	-	6,7	3,06
8	O	8,1	3,63
9	O	10,4	3,01
10	O	8,0	3,02
11	-	4,8	2,82
12	-	5,4	2,92
13	-	6,9	3,26
14	-	5,7	3,22
15	-	0,0	3,12

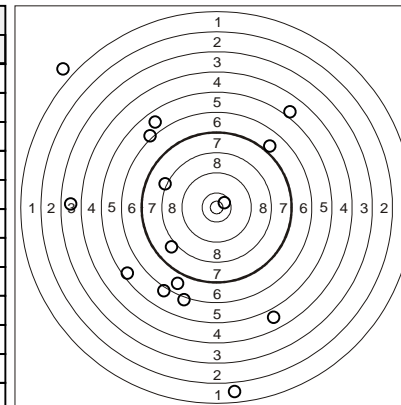

INDIVIDUAL SHOOTING RESULTS

POLISH INTERNATIONAL M.P. TROPHY & EUROPEAN U19 M.P. CUP - MEN HEAT 1

MICHALCZYK Bartosz (POL)

Heat 1			
	H	P	D
Tot	5/1/6	8,2	10,18
1	-	5,3	-
2	O	10,3	1,92
3	O	7,6	2,02
4	O	8,6	1,83
5	O	8,6	2,21
6	O	8,5	2,20

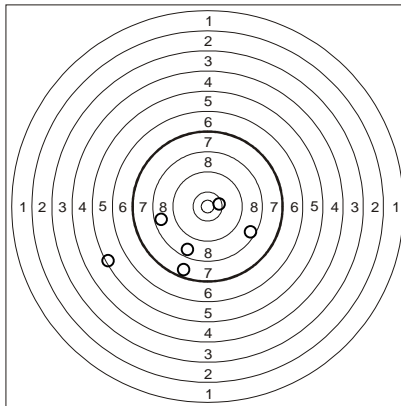

Heat 2			
	H	P	D
Tot	5/4/9	7,5	17,43
1	O	9,5	-
2	-	6,9	1,85
3	O	7,5	2,19
4	O	9,8	1,93
5	-	6,9	2,01
6	-	5,5	2,03
7	-	4,8	2,10
8	O	9,5	2,43
9	O	7,5	2,89

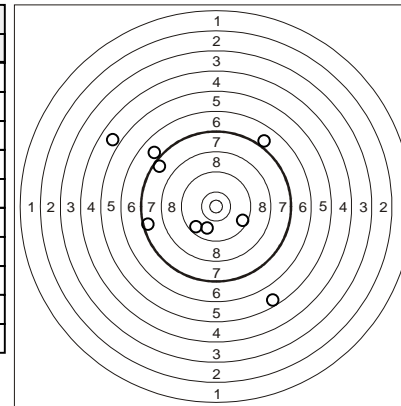

Heat 3			
	H	P	D
Tot	5/2/7	8,1	12,50
1	-	6,2	-
2	O	8,4	2,18
3	O	9,2	2,04
4	O	8,1	2,02
5	-	4,3	2,01
6	O	10,3	2,06
7	O	10,0	2,19

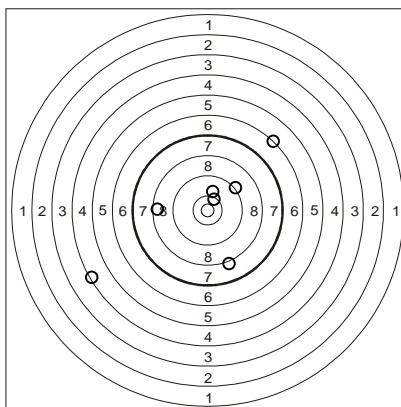

Heat 4			
	H	P	D
Tot	5/3/8	8,2	14,83
1	O	9,0	-
2	-	6,9	2,01
3	O	8,0	1,90
4	O	10,4	1,84
5	O	9,8	1,83
6	-	6,9	1,90
7	-	6,9	2,93
8	O	7,5	2,42

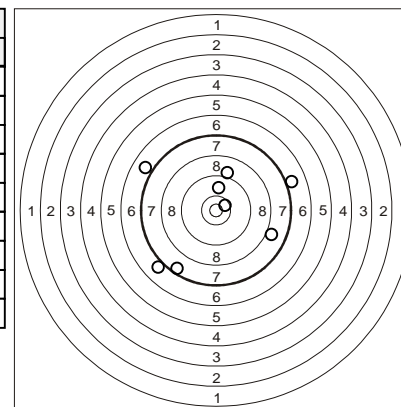

INDIVIDUAL SHOOTING RESULTS

POLISH INTERNATIONAL M.P. TROPHY & EUROPEAN U19 M.P. CUP - MEN HEAT 1

DANA Vojtech (CZE)

Heat 1			
	H	P	D
Tot	5/0/5	9,4	8,74
1	O	7,9	-
2	O	10,0	2,12
3	O	10,3	2,15
4	O	9,3	2,32
5	O	9,6	2,15

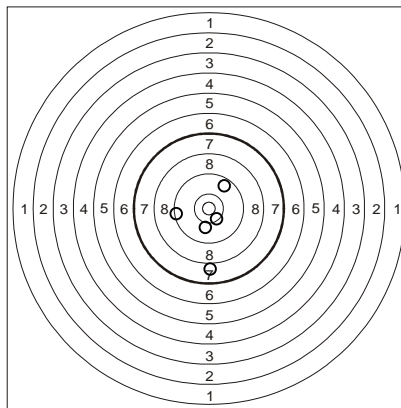

Heat 2			
	H	P	D
Tot	5/4/9	7,5	16,20
1	O	10,1	-
2	-	6,9	2,32
3	-	6,4	1,83
4	O	7,4	1,83
5	O	7,7	2,24
6	-	4,3	1,90
7	-	5,9	1,83
8	O	9,0	1,96
9	O	10,2	2,29

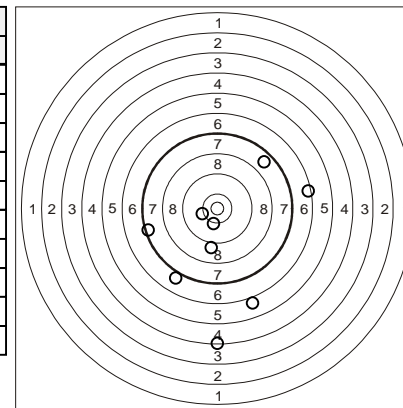

Heat 3			
	H	P	D
Tot	5/0/5	8,1	7,84
1	O	9,6	-
2	O	7,5	2,36
3	O	7,7	1,83
4	O	8,2	1,91
5	O	7,4	1,74

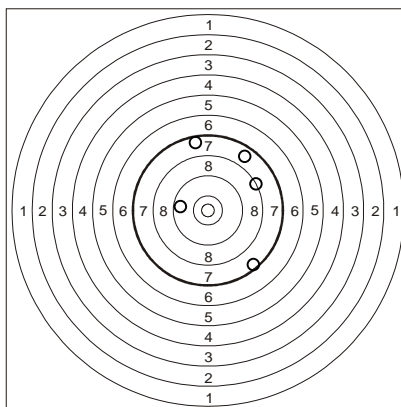

Heat 4			
	H	P	D
Tot	5/5/10	7,8	18,49
1	-	6,5	-
2	-	6,9	2,01
3	O	10,2	2,14
4	-	6,4	2,00
5	-	5,8	2,13
6	-	3,4	2,13
7	O	9,8	2,22
8	O	10,4	1,92
9	O	9,5	1,91
10	O	9,4	2,03

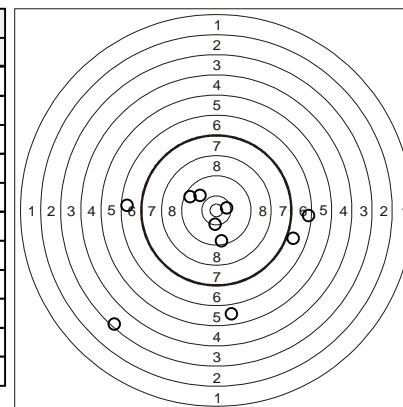

INDIVIDUAL SHOOTING RESULTS

POLISH INTERNATIONAL M.P. TROPHY & EUROPEAN U19 M.P. CUP - MEN HEAT 1

MILUCH Pawel (POL)

Heat 1			
	H	P	D
Tot	5/4/9	6,7	15,01
1	O	8,1	-
2	-	4,8	1,94
3	-	6,1	1,91
4	-	6,9	1,84
5	O	7,9	1,83
6	O	7,8	1,81
7	O	7,4	1,82
8	-	3,9	1,83
9	O	7,8	2,03

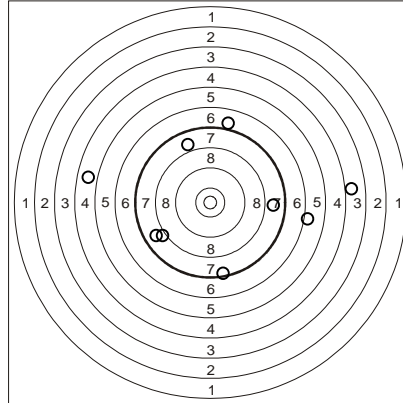

Heat 2			
	H	P	D
Tot	5/11/16	6,7	27,29
1	-	6,5	-
2	-	6,5	2,00
3	-	5,6	1,84
4	-	5,5	1,80
5	O	8,9	1,92
6	-	3,7	1,75
7	O	10,7	1,80
8	-	6,1	1,73
9	-	6,9	1,80
10	-	6,2	1,73
11	-	4,8	1,81
12	O	7,8	1,88
13	-	5,8	1,83
14	O	7,8	1,74
15	-	3,9	1,92
16	O	10,3	1,74

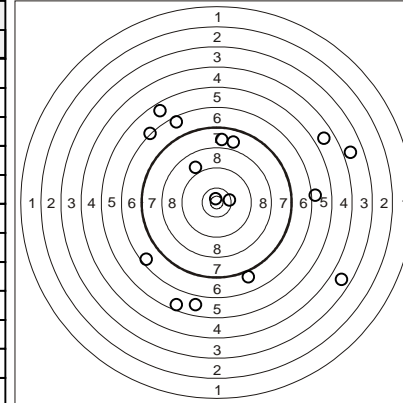

Heat 3			
	H	P	D
Tot	5/2/7	8,4	10,64
1	O	7,6	-
2	-	6,9	1,94
3	O	10,3	1,81
4	O	9,8	1,73
5	-	6,8	1,73
6	O	9,6	1,67
7	O	7,6	1,76

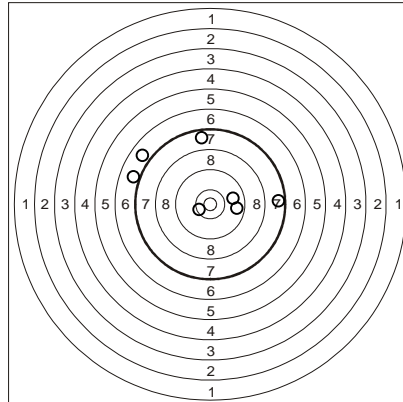

Heat 4			
	H	P	D
Tot	5/6/11	6,1	18,09
1	O	7,4	-
2	-	4,5	1,91
3	-	4,4	1,83
4	-	4,6	1,72
5	-	6,1	1,82
6	-	4,2	1,81
7	O	7,5	1,71
8	O	8,5	1,82
9	O	9,0	1,84
10	-	2,2	1,92
11	O	8,4	1,71

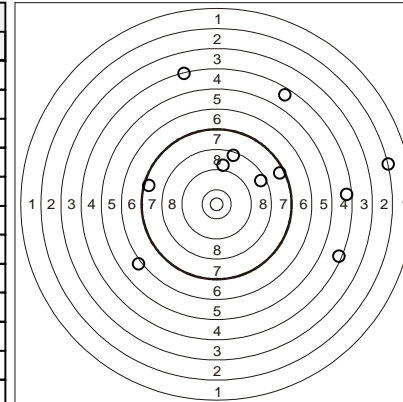

INDIVIDUAL SHOOTING RESULTS

POLISH INTERNATIONAL M.P. TROPHY & EUROPEAN U19 M.P. CUP - MEN HEAT 1

KLIMCZAK Kacper (POL)

Heat 1			
	H	P	D
Tot	5/1/6	7,8	10,35
1	O	7,3	-
2	O	8,3	2,24
3	O	7,2	2,04
4	-	4,5	2,02
5	O	10,2	1,95
6	O	9,1	2,10

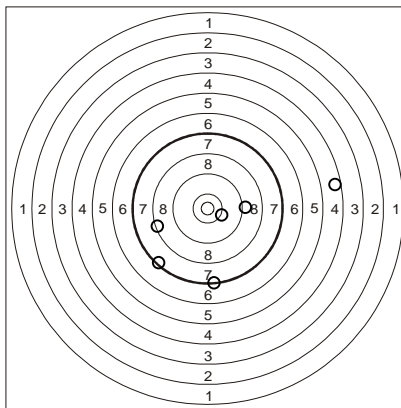

Heat 2			
	H	P	D
Tot	5/2/7	8,1	12,03
1	-	6,3	-
2	O	8,8	2,12
3	O	8,9	2,01
4	O	8,8	2,10
5	-	6,9	1,91
6	O	8,9	1,93
7	O	8,1	1,96

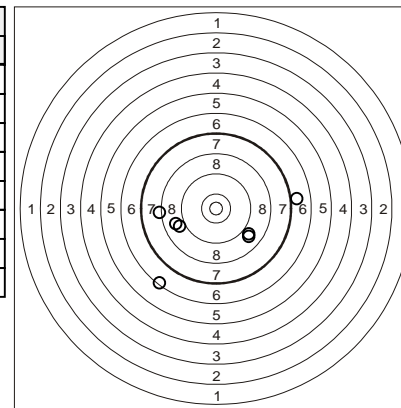

Heat 3			
	H	P	D
Tot	5/2/7	8,2	11,29
1	O	9,1	-
2	-	4,8	2,00
3	O	10,0	1,98
4	-	6,6	2,00
5	O	10,4	1,80
6	O	8,6	1,76
7	O	7,9	1,75

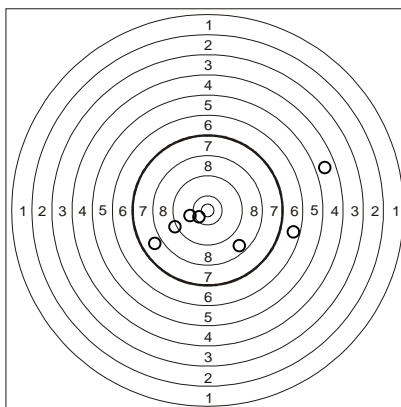

Heat 4			
	H	P	D
Tot	5/3/8	7,7	14,50
1	O	7,8	-
2	-	5,4	1,79
3	O	8,0	1,76
4	-	6,1	1,65
5	-	6,8	1,68
6	O	8,6	1,84
7	O	8,7	3,83
8	O	9,9	1,95

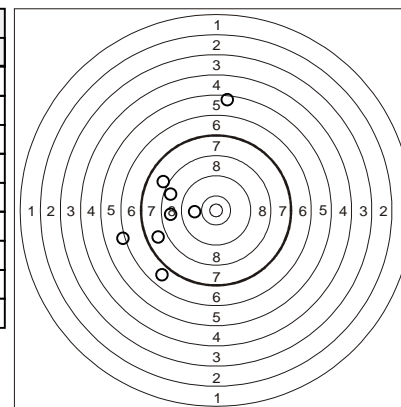

INDIVIDUAL SHOOTING RESULTS

POLISH INTERNATIONAL M.P. TROPHY & EUROPEAN U19 M.P. CUP - MEN HEAT 1

SURMA Stepan (CZE)

Heat 1			
	H	P	D
Tot	5/2/7	7,8	13,38
1	O	8,3	-
2	O	7,5	2,43
3	O	10,4	2,14
4	-	5,6	2,09
5	-	5,9	2,35
6	O	9,3	2,01
7	O	7,8	2,36

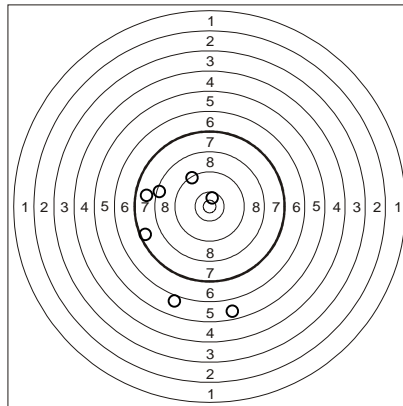

Heat 2			
	H	P	D
Tot	5/3/8	6,9	15,91
1	-	5,5	-
2	O	7,3	2,31
3	-	5,6	2,06
4	-	2,0	2,82
5	O	9,1	2,06
6	O	8,1	2,09
7	O	8,1	2,40
8	O	9,8	2,17

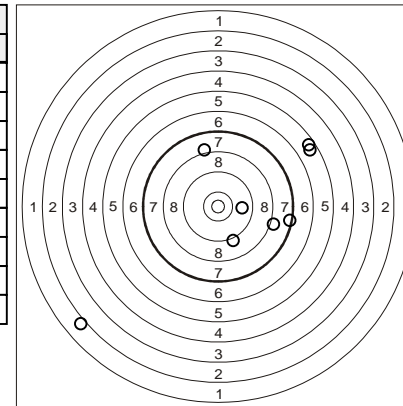

Heat 3			
	H	P	D
Tot	5/1/6	7,4	10,89
1	-	4,5	-
2	O	7,5	2,64
3	O	9,8	2,13
4	O	7,3	2,07
5	O	8,1	2,00
6	O	7,4	2,05

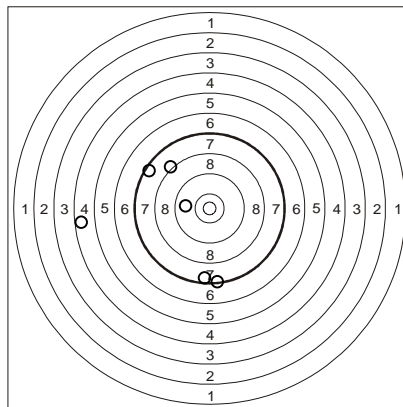

Heat 4			
	H	P	D
Tot	5/2/7	7,4	13,54
1	-	4,9	-
2	O	7,3	2,22
3	O	7,8	2,02
4	O	10,2	2,54
5	-	5,9	2,48
6	O	7,5	2,07
7	O	8,0	2,21

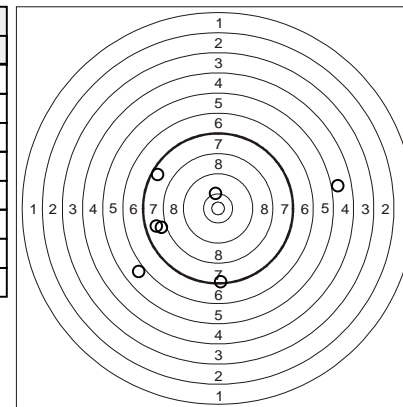

INDIVIDUAL SHOOTING RESULTS

POLISH INTERNATIONAL M.P. TROPHY & EUROPEAN U19 M.P. CUP - MEN HEAT 1

PIERZCHALA Adam (POL)

Heat 1			
	H	P	D
Tot	5/3/8	7,8	14,41
1	O	8,2	-
2	-	6,9	2,25
3	O	7,5	1,99
4	O	10,2	1,95
5	-	6,0	2,14
6	O	8,4	2,01
7	-	6,5	2,02
8	O	8,7	2,05

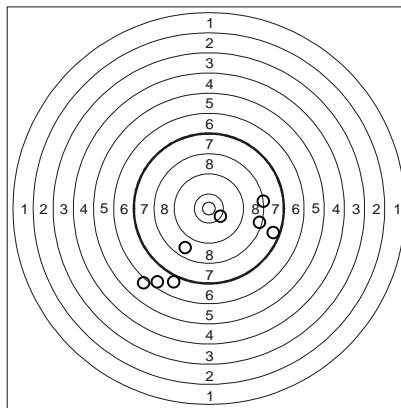

Heat 2			
	H	P	D
Tot	5/3/8	8,2	13,90
1	-	6,0	-
2	-	6,9	2,22
3	O	9,7	2,00
4	-	5,8	1,92
5	O	9,9	1,89
6	O	10,1	1,96
7	O	9,7	2,00
8	O	7,2	1,91

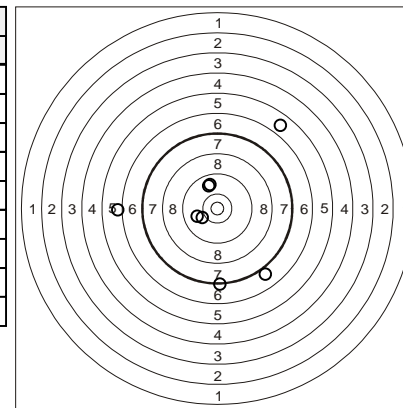

Heat 3			
	H	P	D
Tot	5/5/10	7,3	17,89
1	O	9,0	-
2	-	5,3	2,23
3	O	8,8	2,10
4	-	6,9	2,06
5	O	9,3	1,80
6	O	9,7	1,83
7	-	6,5	1,82
8	-	4,9	2,24
9	-	3,9	1,80
10	O	8,2	2,01

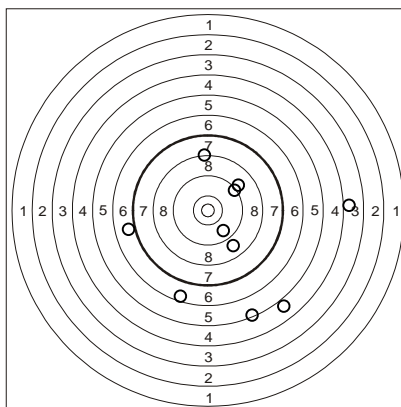

Heat 4			
	H	P	D
Tot	5/4/9	7,6	15,58
1	O	10,3	-
2	-	6,6	1,93
3	O	8,4	2,12
4	O	9,8	1,93
5	-	4,9	1,81
6	O	9,9	1,80
7	-	4,5	1,94
8	-	5,5	2,13
9	O	8,5	1,92

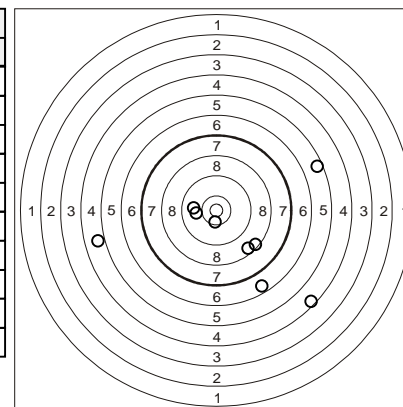

INDIVIDUAL SHOOTING RESULTS

POLISH INTERNATIONAL M.P. TROPHY & EUROPEAN U19 M.P. CUP - MEN HEAT 1

VAGNORIUS Paulius (LTU)

Heat 1			
	H	P	D
Tot	5/4/9	7,2	16,58
1	O	8,3	-
2	-	6,6	2,24
3	O	8,6	1,79
4	-	6,3	2,06
5	O	7,7	2,52
6	-	5,4	1,89
7	O	8,0	1,93
8	-	5,1	1,92
9	O	9,0	2,23

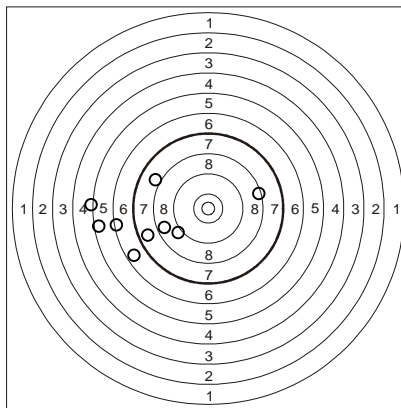

Heat 2			
	H	P	D
Tot	5/5/10	7,3	17,51
1	-	6,2	-
2	-	6,4	1,73
3	-	5,6	1,79
4	O	10,1	2,01
5	O	10,7	1,92
6	-	6,1	1,96
7	O	7,3	2,00
8	O	7,8	2,05
9	-	5,4	2,18
10	O	7,3	1,87

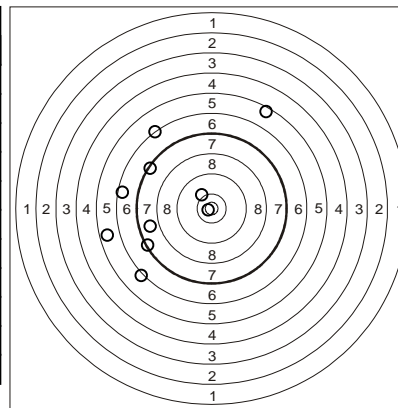

Heat 3			
	H	P	D
Tot	5/10/15	6,7	30,07
1	-	6,2	-
2	O	7,9	2,11
3	-	5,5	1,99
4	-	6,6	1,75
5	-	6,6	2,03
6	O	9,6	1,99
7	O	7,4	2,35
8	-	5,2	2,01
9	-	5,9	2,23
10	-	5,1	2,01
11	O	8,6	2,72
12	-	5,5	2,32
13	-	5,8	2,34
14	-	6,0	2,03
15	O	8,4	2,19

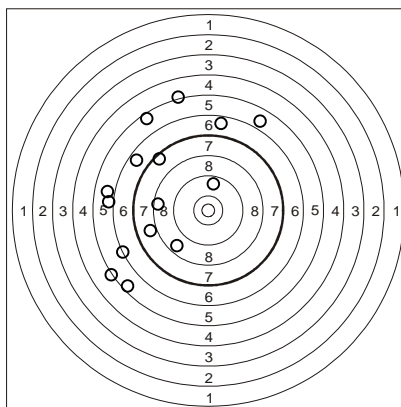

Heat 4			
	H	P	D
Tot	5/3/8	7,4	15,46
1	-	6,9	-
2	-	6,1	1,92
3	O	9,0	2,22
4	O	8,3	1,83
5	O	7,8	1,93
6	-	4,5	3,30
7	O	7,9	2,00
8	O	8,7	2,26

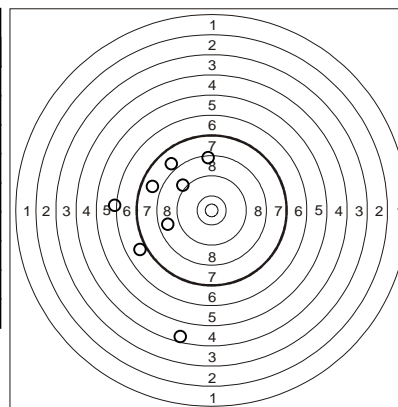

INDIVIDUAL SHOOTING RESULTS

POLISH INTERNATIONAL M.P. TROPHY & EUROPEAN U19 M.P. CUP - MEN HEAT 1

BABEL Eryk (POL)

Heat 1			
	H	P	D
Tot	5/0/5	8,2	7,43
1	O	7,8	-
2	O	7,5	1,94
3	O	7,5	1,83
4	O	8,9	1,82
5	O	9,3	1,84

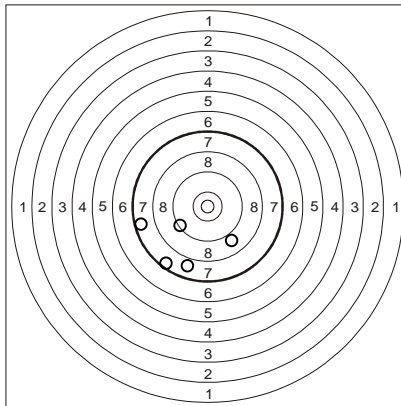

Heat 2			
	H	P	D
Tot	5/3/8	7,5	13,83
1	O	9,8	-
2	-	4,3	2,20
3	O	9,0	1,94
4	-	6,9	2,00
5	O	8,3	1,99
6	O	7,8	1,90
7	-	5,9	1,89
8	O	8,3	1,91

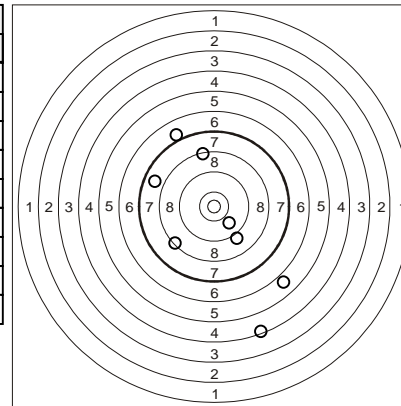

Heat 3			
	H	P	D
Tot	5/4/9	7,2	15,42
1	-	6,9	-
2	O	9,1	1,91
3	O	9,2	2,03
4	-	6,9	1,90
5	-	6,2	1,83
6	O	8,1	2,01
7	-	2,5	1,89
8	O	8,2	1,93
9	O	7,4	1,92

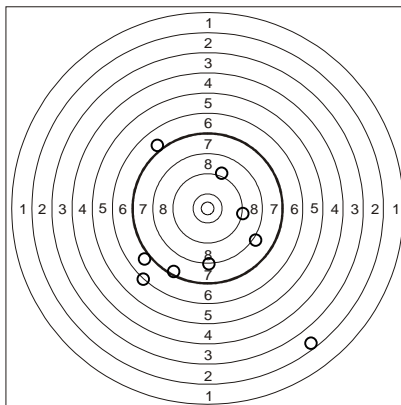

Heat 4			
	H	P	D
Tot	5/9/14	5,8	25,64
1	-	5,3	-
2	-	6,2	2,01
3	O	7,6	1,93
4	-	3,2	2,02
5	O	8,4	1,87
6	-	3,2	1,84
7	-	3,1	2,01
8	-	2,8	2,55
9	-	6,8	1,93
10	-	5,4	1,84
11	-	4,7	1,91
12	O	7,5	1,99
13	O	9,0	1,85
14	O	7,4	1,89

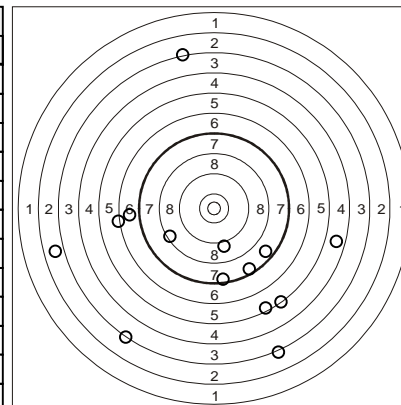

INDIVIDUAL SHOOTING RESULTS

POLISH INTERNATIONAL M.P. TROPHY & EUROPEAN U19 M.P. CUP - MEN HEAT 1

PAJTL Matej (CZE)

Heat 1			
	H	P	D
Tot	5/0/5	8,0	9,46
1	O	8,1	-
2	O	8,7	2,53
3	O	7,4	2,42
4	O	7,2	2,22
5	O	8,5	2,29

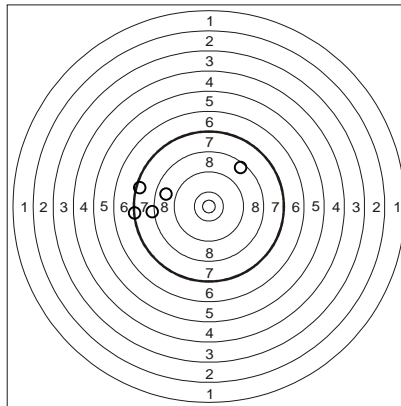

Heat 2			
	H	P	D
Tot	5/1/6	8,1	11,84
1	O	7,9	-
2	O	8,5	2,43
3	O	8,3	2,31
4	-	6,9	2,33
5	O	8,1	2,52
6	O	9,0	2,25

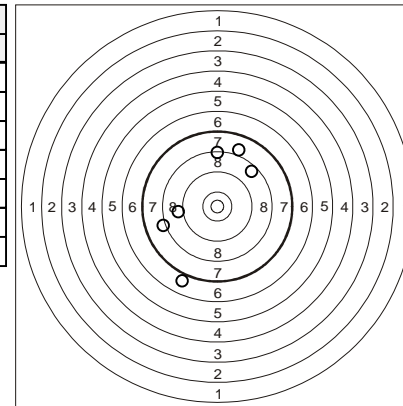

Heat 3			
	H	P	D
Tot	5/7/12	7,7	26,91
1	-	6,9	-
2	-	6,8	2,36
3	O	9,2	2,40
4	-	6,9	2,25
5	-	4,7	2,41
6	-	5,5	2,43
7	O	9,1	2,79
8	O	10,0	2,36
9	-	6,4	2,43
10	-	6,9	2,32
11	O	9,8	2,91
12	O	10,2	2,25

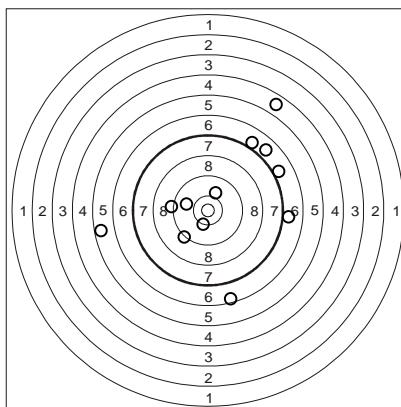

Heat 4			
	H	P	D
Tot	5/3/8	8,2	17,01
1	O	8,0	-
2	O	8,0	2,53
3	O	10,2	2,45
4	-	6,9	2,29
5	-	6,9	2,58
6	-	5,9	2,44
7	O	9,5	2,51
8	O	10,0	2,21

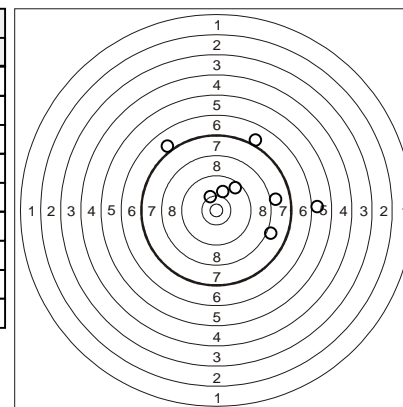

INDIVIDUAL SHOOTING RESULTS

POLISH INTERNATIONAL M.P. TROPHY & EUROPEAN U19 M.P. CUP - MEN HEAT 1

KALAMINSKAS Jonas (LTU)

Heat 1			
	H	P	D
Tot	5/3/8	7,2	13,43
1	-	4,9	-
2	O	7,5	1,73
3	-	6,5	1,70
4	O	7,6	1,79
5	O	9,6	1,73
6	-	6,2	2,60
7	O	8,1	1,88
8	O	7,5	2,00

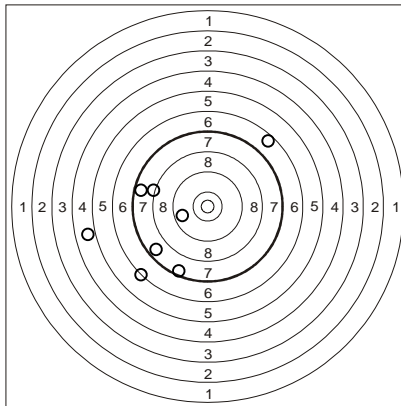

Heat 2			
	H	P	D
Tot	5/4/9	7,5	14,06
1	-	6,8	-
2	-	4,3	1,83
3	O	8,4	1,76
4	O	7,9	1,66
5	-	6,6	1,72
6	-	5,9	1,61
7	O	10,5	1,84
8	O	8,6	1,79
9	O	8,5	1,85

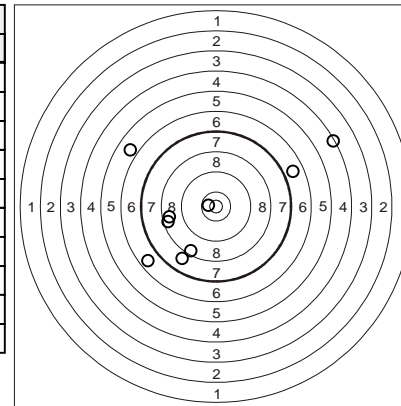

Heat 3			
	H	P	D
Tot	5/2/7	7,5	11,26
1	O	8,7	-
2	-	2,1	2,44
3	-	6,9	1,73
4	O	7,9	1,72
5	O	8,6	1,81
6	O	9,2	1,79
7	O	9,4	1,77

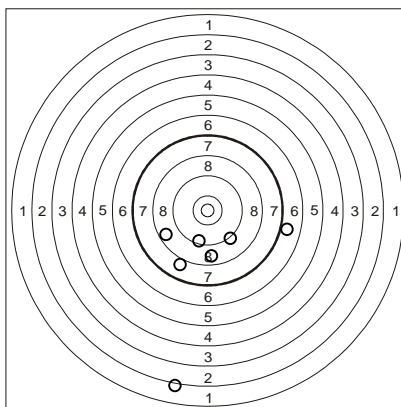

Heat 4			
	H	P	D
Tot	5/2/7	8,2	10,63
1	O	10,2	-
2	-	6,6	1,64
3	O	9,6	1,90
4	-	6,9	1,66
5	O	8,6	1,77
6	O	7,4	1,78
7	O	8,4	1,88

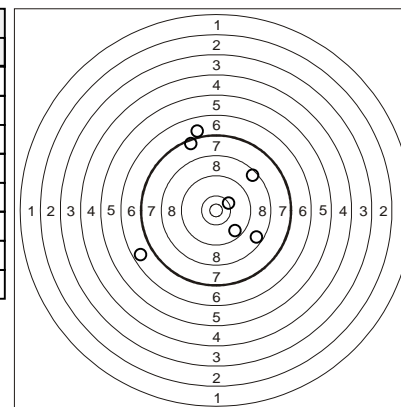

INDIVIDUAL SHOOTING RESULTS

POLISH INTERNATIONAL M.P. TROPHY & EUROPEAN U19 M.P. CUP - MEN HEAT 1

JEVENSAPER Danielius (LTU)

Heat 1			
	H	P	D
Tot	5/3/8	8,1	18,08
1	-	6,9	-
2	O	8,8	2,38
3	-	6,7	2,44
4	O	9,4	2,34
5	-	6,9	3,24
6	O	8,4	2,52
7	O	10,2	2,39
8	O	7,5	2,77

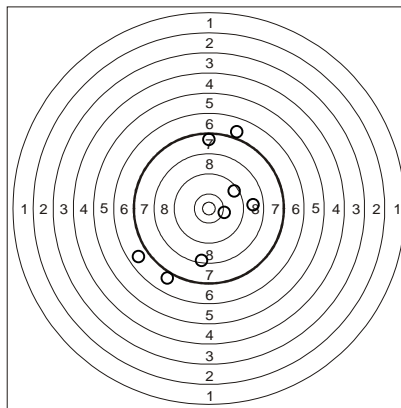

Heat 2			
	H	P	D
Tot	5/5/10	7,6	21,47
1	O	8,7	-
2	-	6,9	2,38
3	-	6,2	2,42
4	-	5,4	2,32
5	O	8,4	2,42
6	O	9,5	2,41
7	-	6,8	2,45
8	-	5,5	2,31
9	O	9,3	2,39
10	O	9,4	2,37

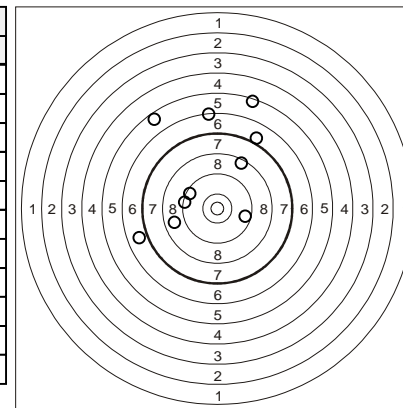

Heat 3			
	H	P	D
Tot	5/2/7	8,3	13,95
1	O	9,8	-
2	-	4,9	2,44
3	-	6,9	2,20
4	O	9,0	2,24
5	O	9,5	2,32
6	O	8,0	2,40
7	O	10,1	2,35

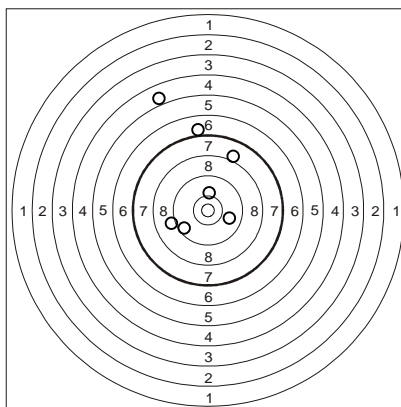

Heat 4			
	H	P	D
Tot	5/0/5	9,1	9,31
1	O	8,7	-
2	O	10,1	2,24
3	O	7,6	2,34
4	O	10,5	2,39
5	O	8,6	2,34

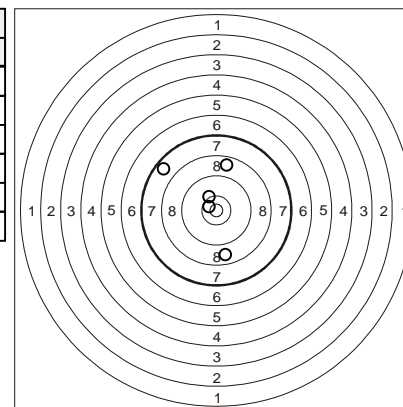

INDIVIDUAL SHOOTING RESULTS

POLISH INTERNATIONAL M.P. TROPHY & EUROPEAN U19 M.P. CUP - MEN HEAT 1

MAREK Przemyslaw (POL)

Heat 1			
	H	P	D
Tot	5/5/10	6,2	24,16
1	O	8,8	-
2	-	1,6	2,71
3	O	7,5	2,97
4	-	6,2	2,77
5	-	5,3	2,26
6	O	7,2	2,46
7	O	7,9	2,37
8	-	3,0	2,49
9	-	4,0	2,77
10	O	10,2	3,36

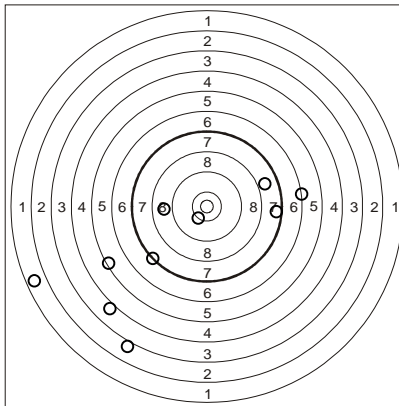

Heat 2			
	H	P	D
Tot	5/0/5	9,1	10,35
1	O	7,5	-
2	O	8,5	2,40
3	O	10,3	2,41
4	O	9,6	3,01
5	O	9,7	2,53

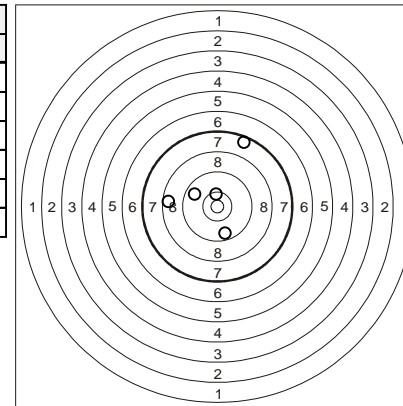

Heat 3			
	H	P	D
Tot	5/7/12	6,4	37,69
1	-	6,1	-
2	-	5,0	2,40
3	-	3,8	2,63
4	O	7,7	2,45
5	-	5,2	14,53
6	O	8,9	2,39
7	O	8,5	2,15
8	-	5,2	2,11
9	-	4,0	2,10
10	-	6,4	2,25
11	O	7,8	2,31
12	O	8,1	2,37

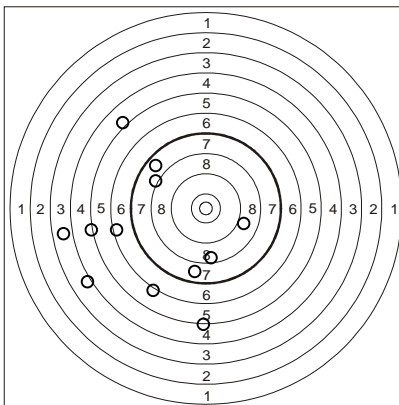

Heat 4			
	H	P	D
Tot	5/3/8	7,7	17,56
1	-	6,1	-
2	-	6,2	2,58
3	O	8,0	2,46
4	-	6,8	2,41
5	O	7,4	2,90
6	O	9,2	2,40
7	O	9,5	2,34
8	O	8,5	2,47

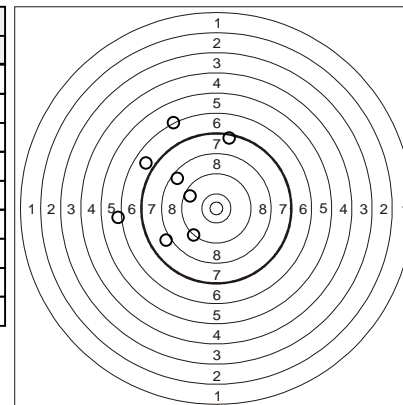

INDIVIDUAL SHOOTING RESULTS

POLISH INTERNATIONAL M.P. TROPHY & EUROPEAN U19 M.P. CUP - MEN HEAT 1

BARKAUSKAS Deividas (LTU)

Heat 1			
	H	P	D
Tot	5/9/14	7,3	37,53
1	O	7,9	-
2	-	6,5	2,40
3	-	5,5	2,51
4	-	6,8	2,56
5	-	6,9	2,61
6	O	9,2	3,09
7	-	6,2	2,35
8	-	6,9	2,42
9	-	6,3	2,42
10	O	8,4	3,13
11	-	6,9	2,65
12	O	8,3	5,64
13	-	6,9	2,98
14	O	9,6	2,77

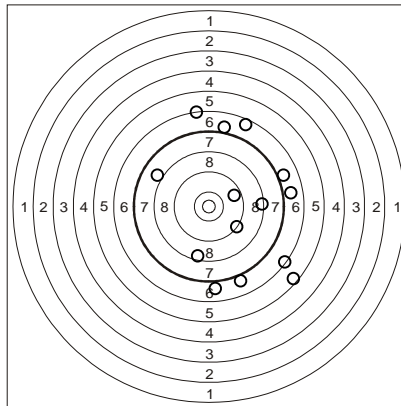

Heat 2			
	H	P	D
Tot	5/5/10	7,3	22,84
1	-	4,9	-
2	O	9,7	2,56
3	O	10,0	2,57
4	-	6,9	2,23
5	-	3,6	2,55
6	O	7,4	2,61
7	-	6,2	2,31
8	O	9,5	2,55
9	-	6,8	2,41
10	O	7,8	3,05

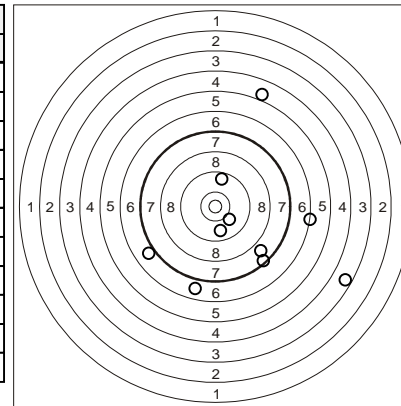

Heat 3			
	H	P	D
Tot	5/2/7	7,1	15,15
1	O	7,7	-
2	O	7,8	2,65
3	-	2,4	2,25
4	-	6,9	2,33
5	O	8,2	2,48
6	O	9,2	2,35
7	O	7,3	3,09

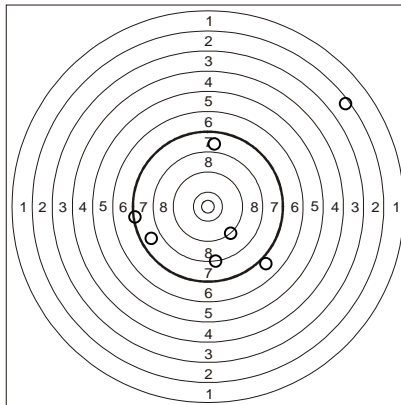

Heat 4			
	H	P	D
Tot	5/5/10	7,0	22,11
1	O	7,8	-
2	-	5,1	2,59
3	-	6,9	2,54
4	-	3,3	2,63
5	O	7,7	2,52
6	-	5,6	2,42
7	O	8,4	2,40
8	-	6,9	2,34
9	O	9,0	2,32
10	O	9,1	2,35

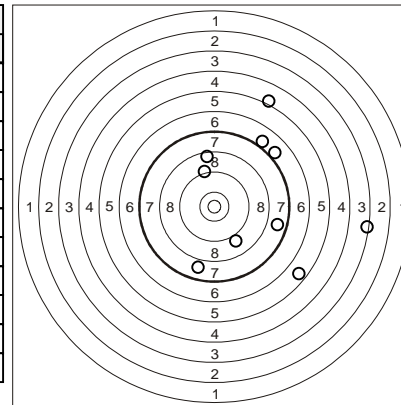

INDIVIDUAL SHOOTING RESULTS

POLISH INTERNATIONAL M.P. TROPHY & EUROPEAN U19 M.P. CUP - MEN HEAT 1

NOSEK Jan (CZE)

Heat 1			
	H	P	D
Tot	5/0/5	8,6	10,26
1	O	7,3	-
2	O	8,6	2,40
3	O	9,7	2,44
4	O	8,4	2,99
5	O	8,8	2,43

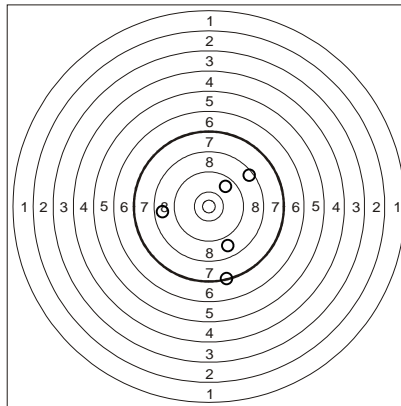

Heat 2			
	H	P	D
Tot	5/2/7	8,1	14,49
1	-	6,7	-
2	O	8,1	2,22
3	O	10,2	2,21
4	-	6,6	2,12
5	O	8,5	2,81
6	O	7,7	2,66
7	O	8,6	2,47

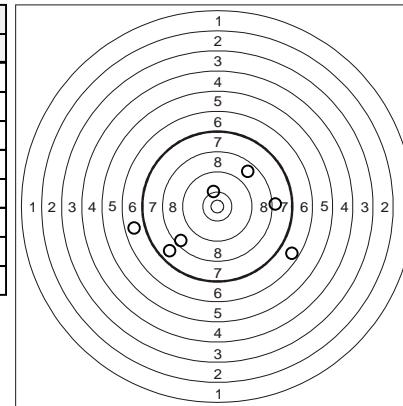

Heat 3			
	H	P	D
Tot	5/5/10	7,5	22,69
1	-	6,9	-
2	O	9,5	2,39
3	O	7,4	2,23
4	-	6,9	2,13
5	-	6,1	2,52
6	O	8,4	4,71
7	-	6,4	2,14
8	O	7,6	2,21
9	-	5,7	2,09
10	O	10,1	2,27

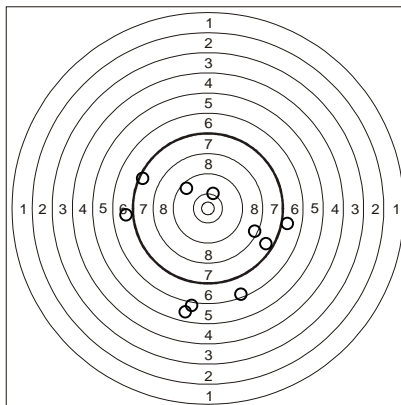

Heat 4			
	H	P	D
Tot	5/7/12	6,9	28,59
1	-	5,7	-
2	-	2,7	2,31
3	O	9,0	2,48
4	O	9,4	1,98
5	-	6,9	2,25
6	-	6,9	2,92
7	-	3,2	2,22
8	O	9,9	5,07
9	-	6,7	2,38
10	-	4,4	2,25
11	O	8,1	2,13
12	O	9,3	2,60

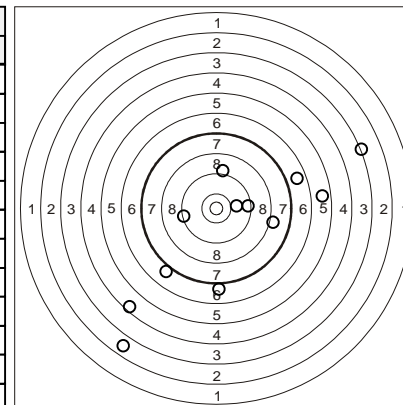

INDIVIDUAL SHOOTING RESULTS

POLISH INTERNATIONAL M.P. TROPHY & EUROPEAN U19 M.P. CUP - MEN HEAT 1

PIECHOTA Bartłomiej (POL)

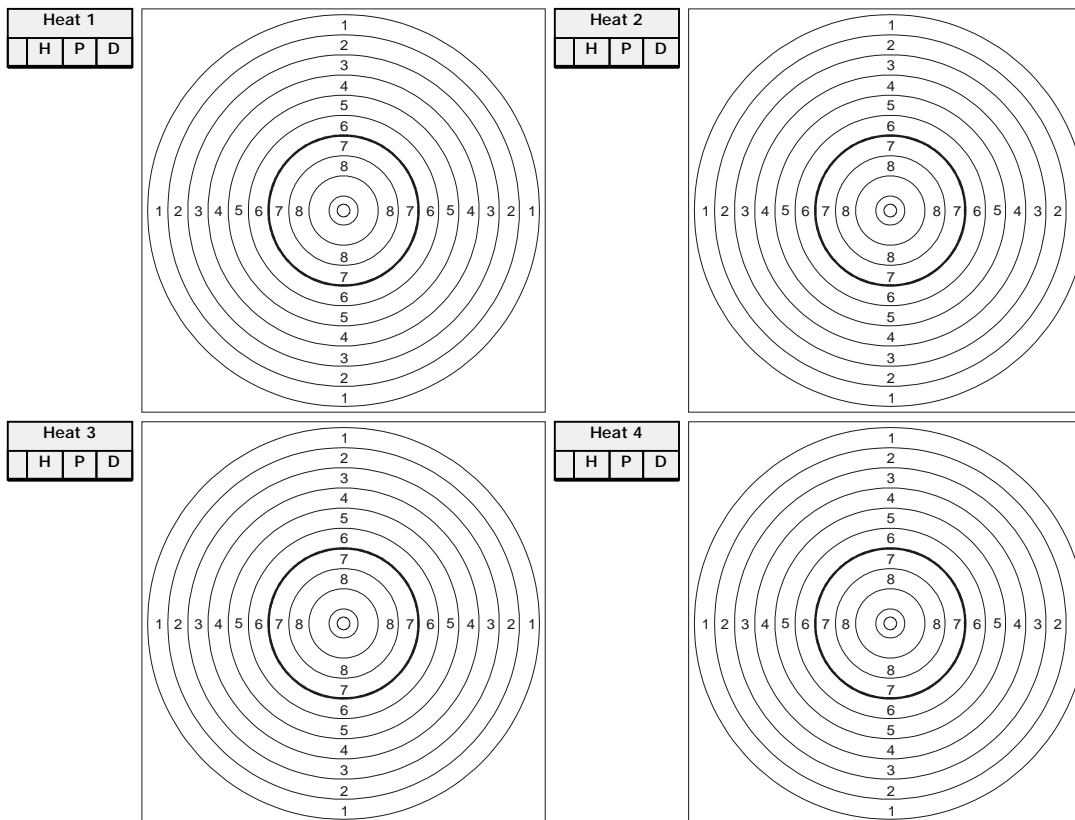

INDIVIDUAL SHOOTING RESULTS

POLISH INTERNATIONAL M.P. TROPHY & EUROPEAN U19 M.P. CUP - MEN HEAT 1

HENDRYSIAK Bartosz (POL)

Heat 1			
	H	P	D
Tot	5/5/10	7,1	22,58
1	-	5,1	-
2	O	8,4	4,67
3	-	6,8	2,15
4	O	7,2	2,39
5	-	5,4	2,05
6	-	6,2	2,19
7	O	10,4	2,14
8	O	8,4	2,41
9	-	3,5	2,23
10	O	9,2	2,35

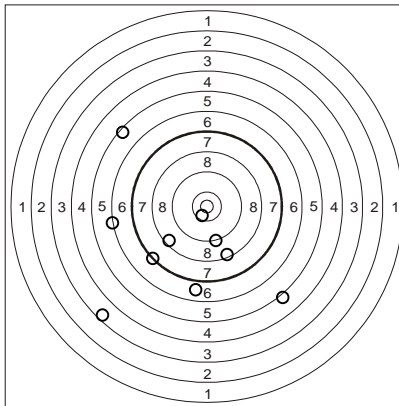

Heat 2			
	H	P	D
Tot	5/3/8	6,6	16,20
1	-	0,0	-
2	-	6,0	2,35
3	O	9,5	2,30
4	-	6,4	2,32
5	O	8,3	2,25
6	O	7,5	2,31
7	O	8,0	2,37
8	O	7,2	2,30

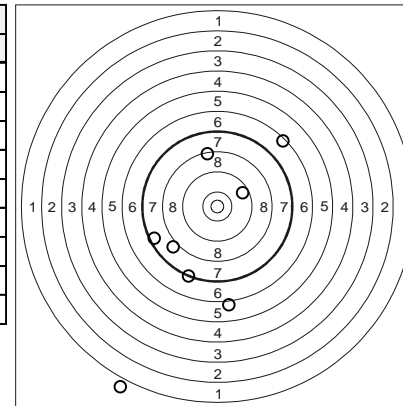

Heat 3			
	H	P	D
Tot	5/8/13	7,4	27,26
1	-	6,8	-
2	-	6,6	2,36
3	O	9,3	2,31
4	-	6,9	2,25
5	O	8,4	2,26
6	-	6,6	2,21
7	O	9,2	2,22
8	-	4,3	2,33
9	-	6,9	2,22
10	-	6,9	2,23
11	-	4,8	2,34
12	O	10,2	2,26
13	O	9,2	2,27

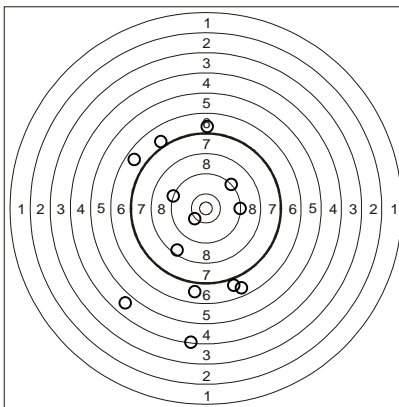

Heat 4			
	H	P	D
Tot	5/3/8	6,8	16,45
1	-	6,9	-
2	-	2,0	2,40
3	O	9,6	3,11
4	-	2,4	2,21
5	O	8,9	2,26
6	O	9,1	2,19
7	O	8,2	2,05
8	O	7,6	2,23

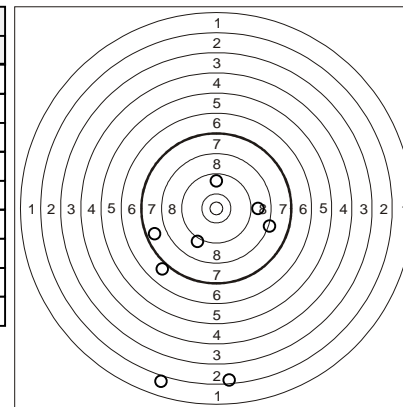

INDIVIDUAL SHOOTING RESULTS

POLISH INTERNATIONAL M.P. TROPHY & EUROPEAN U19 M.P. CUP - MEN HEAT 1

BARAN Maciej (POL)

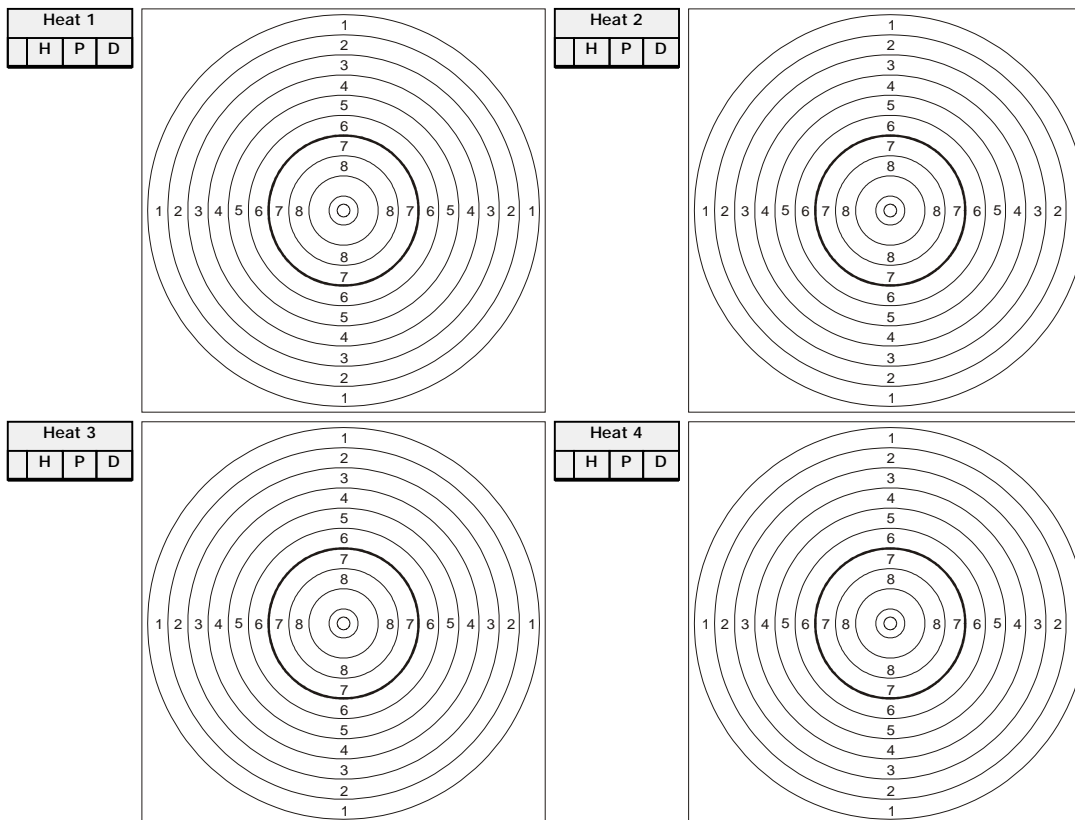

INDIVIDUAL SHOOTING RESULTS

POLISH INTERNATIONAL M.P. TROPHY & EUROPEAN U19 M.P. CUP - MEN HEAT 1

KORNEL Matej (CZE)

Heat 1			
	H	P	D
Tot	5/1/6	8,4	12,47
1	-	5,7	-
2	O	7,6	2,86
3	O	8,2	2,69
4	O	8,7	2,46
5	O	10,6	2,21
6	O	9,7	2,25

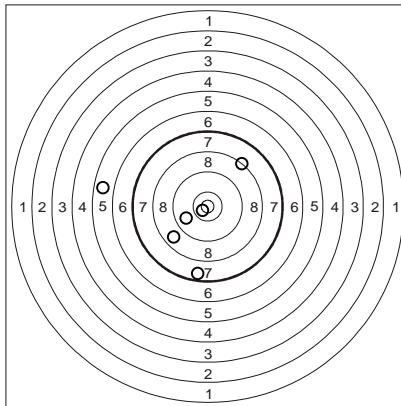

Heat 2			
	H	P	D
Tot	5/2/7	8,5	16,67
1	O	9,3	-
2	-	6,0	2,93
3	O	9,8	2,61
4	O	9,7	2,65
5	O	8,9	2,33
6	-	6,7	2,92
7	O	9,2	3,23

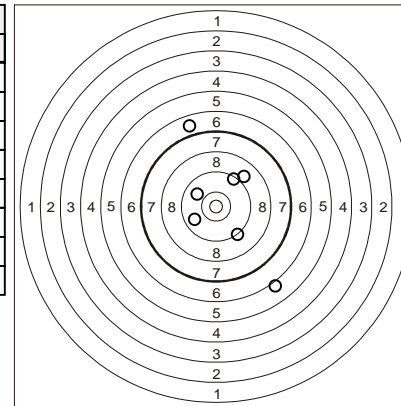

Heat 3			
	H	P	D
Tot	5/4/9	7,5	22,19
1	-	3,8	-
2	-	6,5	3,05
3	O	8,9	2,79
4	-	6,9	2,91
5	-	6,9	2,45
6	O	8,7	2,83
7	O	7,8	2,78
8	O	9,4	2,56
9	O	8,2	2,82

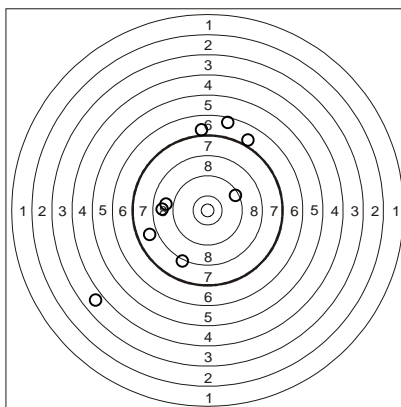

Heat 4			
	H	P	D
Tot	5/0/5	9,0	9,89
1	O	8,5	-
2	O	10,1	2,65
3	O	7,8	2,32
4	O	9,0	2,40
5	O	9,4	2,52

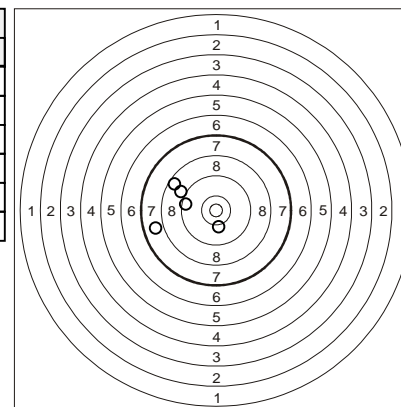

INDIVIDUAL SHOOTING RESULTS

POLISH INTERNATIONAL M.P. TROPHY & EUROPEAN U19 M.P. CUP - MEN HEAT 1

VENGLAR Daniel (CZE)

Heat 1			
	H	P	D
Tot	5/3/8	8,3	22,04
1	O	9,5	-
2	-	5,5	2,65
3	-	5,9	2,72
4	O	9,5	2,96
5	O	8,7	2,81
6	O	9,6	2,93
7	-	6,9	4,85
8	O	10,4	3,12

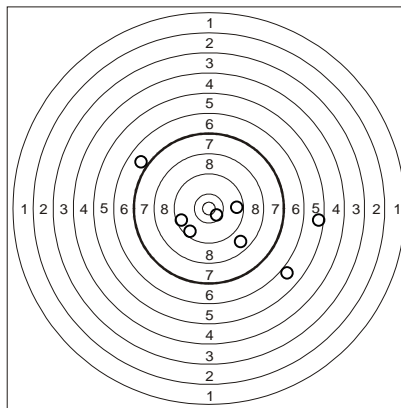

Heat 2			
	H	P	D
Tot	5/8/13	6,9	39,20
1	-	5,9	-
2	-	5,6	3,45
3	O	8,3	3,71
4	-	6,0	3,66
5	O	10,0	3,03
6	-	6,4	3,15
7	-	6,9	3,13
8	O	9,3	3,09
9	O	9,3	3,15
10	-	3,1	3,23
11	-	2,4	3,17
12	-	6,9	3,30
13	O	9,2	3,13

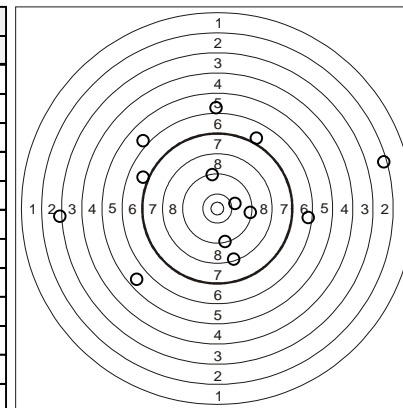

Heat 3			
	H	P	D
Tot	5/7/12	6,6	39,77
1	-	6,8	-
2	-	6,9	3,35
3	-	2,7	3,61
4	O	8,0	4,21
5	-	4,8	3,94
6	O	8,5	3,34
7	O	9,7	3,73
8	-	2,6	3,63
9	O	7,7	3,95
10	-	5,5	3,22
11	-	6,7	3,56
12	O	9,5	3,23

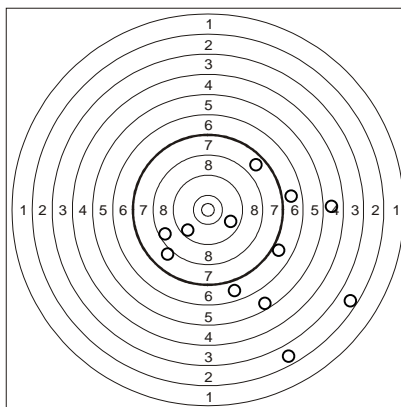

Heat 4			
	H	P	D
Tot	5/4/9	6,9	27,97
1	-	4,2	-
2	-	6,9	3,73
3	-	5,7	3,39
4	O	7,9	3,47
5	O	9,0	4,35
6	-	4,6	3,13
7	O	8,2	3,74
8	O	7,6	3,20
9	O	7,9	2,96

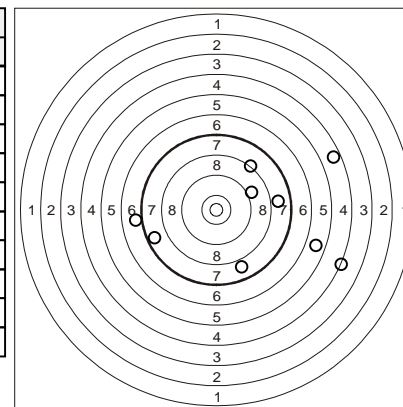

INDIVIDUAL SHOOTING RESULTS

POLISH INTERNATIONAL M.P. TROPHY & EUROPEAN U19 M.P. CUP - MEN HEAT 1

VONDRA Matous (CZE)

Heat 1			
	H	P	D
Tot	5/6/11	6,9	27,92
1	-	6,9	-
2	-	6,7	2,87
3	-	2,9	2,70
4	-	5,6	2,86
5	O	8,8	2,82
6	-	6,5	3,02
7	O	7,3	3,01
8	-	6,9	2,46
9	O	7,7	2,71
10	O	8,2	2,52
11	O	7,9	2,95

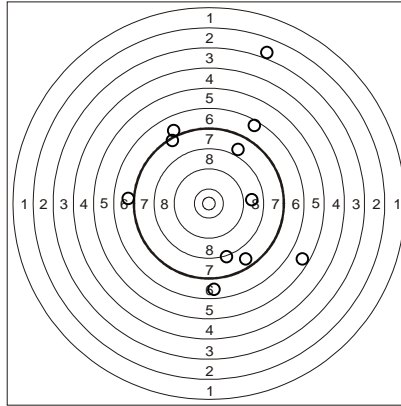

Heat 2			
	H	P	D
Tot	5/9/14	6,7	35,72
1	-	2,5	-
2	-	6,9	3,08
3	-	5,4	3,00
4	O	9,1	2,53
5	-	5,3	2,64
6	O	8,2	2,48
7	-	3,7	2,74
8	O	9,3	2,66
9	-	6,9	2,67
10	-	6,9	2,79
11	-	5,9	2,83
12	-	6,1	2,83
13	O	7,5	2,98
14	O	9,7	2,49

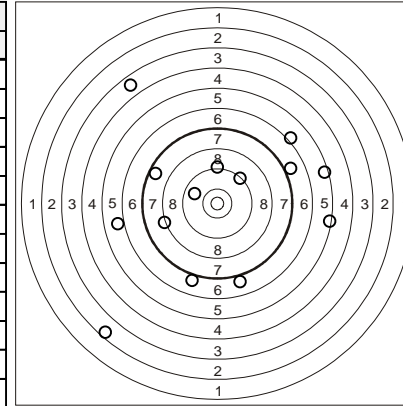

Heat 3			
	H	P	D
Tot	5/3/8	7,7	18,18
1	-	4,1	-
2	O	8,7	2,85
3	O	8,7	2,51
4	-	5,8	2,39
5	O	8,5	2,63
6	-	6,9	2,25
7	O	10,0	2,40
8	O	9,0	3,15

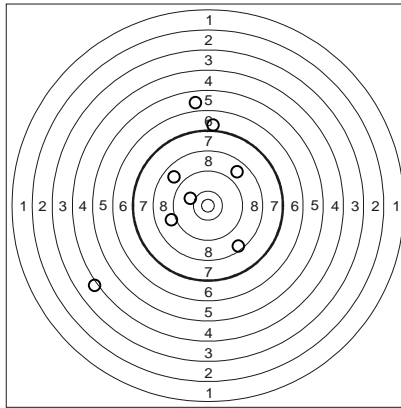

Heat 4			
	H	P	D
Tot	5/3/8	7,8	17,83
1	-	6,6	-
2	O	9,2	2,58
3	-	6,3	2,52
4	O	7,8	2,63
5	O	8,7	2,49
6	-	5,0	2,52
7	O	9,4	2,45
8	O	9,2	2,64

